

ELECTRONIC CASH REGISTER
TE-3000S

User's Manual

Introduction

Setting Up

Getting Started

Paper Installation

Set Date/time

Introducing the Terminal

Display/Keyboard

Basic Operations & Setups

Registrations

Programs

Advanced Operations

Useful Features

Reports

Troubleshooting

Error Code Table

User Maintenance

Paper Replacement



Eu

Di

U.K.

CI

Canada

CASIO®

www.cashregisters.net

Introduction

Congratulations on your selection of a CASIO TE-3000S series electronic cash register. This ECR is the product of the world's most advanced electronic technology, for outstanding versatility and reliability. Simplified operation is made possible by a specially designed keyboard layout and a wide selection of automated, programmable functions.

A specially designed keyboard layout and a bright, easy-to-read display help to take the fatigue out of long hours operation.



Casio Electronics Co., Ltd.
Unit 6, 1000 North Circular Road
London NW2 7JD, U.K.

WARNING: This is a Class A product. In a domestic environment this product may cause radio interference in which case the user may be required to take adequate measures.

Please keep all information for future reference.

GUIDELINES LAID DOWN BY FCC RULES FOR USE OF THE UNIT IN THE U.S.A. (Not applicable to other areas)

WARNING: This equipment has been tested and found to comply with the limits for a Class A digital device, pursuant to Part 15 of the FCC Rules. These limits are designed to provide reasonable protection against harmful interference when the equipment is operated in a commercial environment. This equipment generates, uses, and can radiate radio frequency energy and, if not installed and used in accordance with the instruction manual, may cause harmful interference to radio communications. Operation of this equipment in a residential area is likely to cause harmful interference in which case the user will be required to correct the interference at his own expense.

FCC WARNING: Changes or modifications not expressly approved by the party responsible for compliance could void the user's authority to operate the equipment.

Apparaten skall anslutas till jordat nätuttag.

The main plug on this equipment must be used to disconnect mains power. Please ensure that the socket outlet is installed near the equipment and shall be easily accessible.

Safety Precautions

- To use this product safely and correctly, read this manual thoroughly and operate as instructed.
After reading this guide, keep it close at hand for easy reference.
Please keep all informations for future reference.
- Always observe the warnings and cautions indicated on the product.

About the icons

In this guide various icons are used to highlight safe operation of this product and to prevent injury to the operator and other personnel and also to prevent damage to property and this product. The icons and definitions are given below.



Indicates that there is a risk of severe injury or death if used incorrectly.



Indicates that injury or damage may result if used incorrectly.

Icon examples

To bring attention to risks and possible damage, the following types of icons are used.



The \triangle symbol indicates that it includes some symbol for attracting attention (including warning). In this triangle the actual type of precautions to be taken (electric shock, in this case) is indicated.



The \otimes symbol indicates a prohibited action. In this symbol the actual type of prohibited actions (disassembly, in this case) will be indicated.



The \bullet symbol indicates a restriction. In this symbol the type of actual restriction (removal of the power plug from an outlet, in this case) is indicated.

Warning!

Handling the register



Should the register malfunction, start to emit smoke or a strange odor, or otherwise behave abnormally, immediately shut down the power and unplug the AC plug from the power outlet. Continued use creates the danger of fire and electric shock.

- Contact CASIO service representative.



Do not place containers of liquids near the register and do not allow any foreign matter to get into it. Should water or other foreign matter get into the register, immediately shut down the power and unplug the AC plug from the power outlet. Continued use creates the danger of shorting, fire and electric shock.

- Contact CASIO service representative.



Should you drop the register and damage it, immediately shut down the power and unplug the AC plug from the power outlet. Continued use creates the danger of shorting, fire and electric shock.

- Attempting to repair the register yourself is extremely dangerous. Contact CASIO service representative.
-

⚠ Warning!



Never try to take the register apart or modify it in any way. High-voltage components inside the register create the danger of fire and electric shock.

- Contact CASIO service representative for all repair and maintenance.

Power plug and AC outlet



Use only a proper AC electric outlet (100V~240V) . Use of an outlet with a different voltage from the rating creates the danger of malfunction, fire, and electric shock. Overloading an electric outlet creates the danger of overheating and fire.



Make sure the power plug is inserted as far as it will go. Loose plugs create the danger of electric shock, overheating, and fire.

- Do not use the register if the plug is damaged. Never connect to a power outlet that is loose.



Use a dry cloth to periodically wipe off any dust built up on the prongs of the plug. Humidity can cause poor insulation and create the danger of electric shock and fire if dust stays on the prongs.



Do not allow the power cord or plug to become damaged, and never try to modify them in any way. Continued use of a damaged power cord can cause deterioration of the insulation, exposure of internal wiring, and shorting, which creates the danger of electric shock and fire.

- Contact CASIO service representative whenever the power cord or plug requires repair or maintenance.

⚠ Caution!



Do not place the register on an unstable or uneven surface. Doing so can cause the register — especially when the drawer is open — to fall, creating the danger of malfunction, fire, and electric shock.



Do not place the register in the following areas.

- Areas where the register will be subject to large amounts of humidity or dust, or directly exposed to hot or cold air.
- Areas exposed to direct sunlight, in a close motor vehicle, or any other area subject to very high temperatures.

The above conditions can cause malfunction, which creates the danger of fire.



Do not overlay bend the power cord, do not allow it to be caught between desks or other furniture, and never place heavy objects on top of the power cord. Doing so can cause shorting or breaking of the power cord, creating the danger of fire and electric shock.



Be sure to grasp the plug when unplugging the power cord from the wall outlet. Pulling on the cord can damage it, break the wiring, or cause short, creating the danger of fire and electric shock.



Never touch the plug while your hands are wet. Doing so creates the danger of electric shock. Pulling on the cord can damage it, break the wiring, or cause short, creating the danger of fire and electric shock.

Never touch the printer head and the platen.

Introduction & Contents

Introduction & Contents	3
Getting Started	10
Remove the cash register from its box.	10
Remove the tape holding parts of the cash register in place.	10
Remove the cash drawer from its box.	10
Connect the drawer.	10
Mount the cash register.	11
Plug the cash register into a wall outlet.	11
Insert the mode key marked "OW" into the mode switch.	11
Install receipt/journal paper.	12
Set the date.	15
Set the time.	15
Introducing TE-3000S	16
General guide	16
Display	20
Keyboard	22
Allocatable functions	24
Basic Operations and Setups	26
How to read the printouts	26
How to use your cash register	27
Assigning a clerk	28
Clerk button	28
Clerk lock/clerk key	28
Clerk secret number key	28
Displaying the time and date	29
To display and clear the date/time	29
Preparing coins for change	29
Preparing and using department keys	30
Registering department keys	30
Programming department keys	31
To program a unit price for each department	31
To program the tax calculation status for each department	31
To program high amount limit for each department	32
Registering department keys by programming data	33
Preset price	33
Preset tax status	33
Locking out high amount limitation	33
Preparing and using PLUs	34
Programming PLUs	34
To program a unit price for each PLU	34
To program tax calculation status for each PLU	34
Registering PLUs	35
Shifting the taxable status of an item	37
Calculation merchandise subtotal	37
Preparing and using discounts	38
Programming discounts	38
Registering discounts	38
Discount for items and subtotals	38
Preparing and using reductions	39
Programming for reductions	39
To program preset reduction amount	39
Registering reductions	39
Reduction for items	39
Reduction for subtotal	40

Registering credit and check payments	41
Check	41
Credit	41
Mixed tender (cash, credit and check)	41
Registering both the Euro and local currency	42
Registering returned goods in the REG mode	44
Registering returned goods in the RF mode	44
Normal refund transaction	44
Reduction of amounts paid on refund	45
Registering money received on account	45
Registering money paid out	45
Registering loan amounts	46
Registering pick up amounts	46
Changing media in drawer	46
Making corrections in a registration	47
To correct an item you input but not yet registered	47
To correct an item you input and registered	48
To cancel all items in a transaction	49
No sale registration	49
Printing the daily sales reset report	50
Advanced Operations	52
Stock check	52
Clerk interrupt function	52
Single item cash sales	53
Addition	54
Addition (plus)	54
Premium (%+)	55
Tray total	56
Tray total premium/discount	56
Multiple item totalling function	56
Coupon transactions	57
Coupon registration using <COUPON> (coupon key)	57
Coupon registration using <COUPON2> (coupon 2 key)	57
Registering the second unit price	58
Preset tender amount	59
Bottle link operation	60
Bottle returns	60
Bottle return key	60
Arrangement key registrations	61
Set menu	61
Currency exchange function	62
Registering foreign currency	62
Full amount tender in foreign currency	62
Partial tender in a foreign currency	63
Food stamp function	64
Food stamp registration	64
No change due	64
Mixed food stamp/cash change	65
Food stamp registration (Illinois rule)	67
No change due	67
Mixed food stamp/cash change	69
Electronic benefits transfer	71
About mixed EBT card tenders	71
No change due	71

Introduction & Contents

Tips	72
Inputting the number of customers	73
Temporarily releasing compulsion	74
Text recall	74
Printing slip	75
Printing slips	75
To perform auto batch printing 1	76
To perform auto batch printing 2	76
About the maximum number of slip lines	76
Check tracking systems	76
Check tracking system	76
Opening a check	77
Adding to a check	77
Issuing a guest receipt	78
Closing a check memory	78
New/old check key operation	79
Add check	80
Separate check	81
Clerk transfer	82
Table transfer	82
Price reductions (red price)	83
Condiment/preparation PLUs	84
VAT breakdown printing	85
Deposit registrations	85
Deposit from customer	85
Deposit from customer during sales transaction	85
Bill copy	86
Actual stock quantity inquiry	87
Unit price inquiry	87
Previous item void using <review>	88
Scanning PLU	89
Item registration	89
By scanner/code input/one touch NLU key	89
Not found PLU	89
Programming to clerk	90
Programming clerk number	90
Programming trainee status	90
Programming commission rate	90
Programming descriptors and messages	91
Programming receipt message, machine No. and clerk name	91
Programming department key descriptor	93
Programming transaction key descriptor	94
Entering characters	95
Using character keyboard	95
Entering characters by code	96
Character code list	96
Editing characters	97
Correcting a character just entered	97
Correcting and adding a PLU descriptor already set	97
Correcting a key descriptor already set	97
Correcting a message descriptor already set	97

Printing read/reset reports	98
To print the individual department, PLU/flat-PLU read report	98
To print the financial read report	99
To print the individual clerk read/reset report	99
To print the daily sales read/reset report	100
To print the PLU/flat-PLU read/reset report	102
To print the hourly sales read/reset report	102
To print the monthly sales read/reset report	103
To print the group read/reset report	103
To print the periodic 1/2 sales read/reset reports	104
To print other sales read/reset reports	106
Reading the cash register's program	107
To print unit price/rate program (except PLU/scanning PLU)	107
To print key descriptor, name, message program (except PLU)	108
To print the PLU/flat-PLU program	109
Troubleshooting	110
When an error occurs	110
When the register does not operate at all	112
Clearing a machine lock up	113
In case of power failure	113
User Maintenance and Options	114
To replace journal paper	114
To replace receipt paper	115
Options	115
Specifications	116
Index	117

Getting Started

This section outlines how to unpack the cash register and get it ready to operate. You should read this part of the manual even if you have used a cash register before. The following is the basic set up procedure, along with page references where you should look for more details.

1. Remove the cash register from its box.

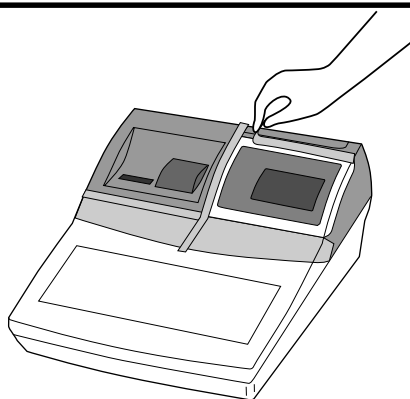
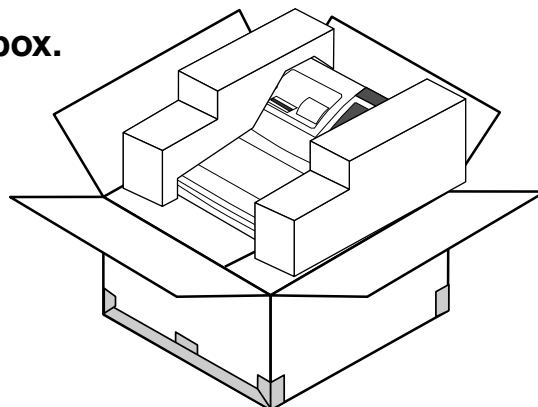

2. Remove the tape holding parts of the cash register in place.

Also remove the small plastic bag taped to the printer cover. Inside you will find the mode keys.

3. Remove the cash drawer from its box.

The cash register and cash drawer are packed separately.

4. Connect the drawer.

1. Connect drawer connector (three color lead on drawer) to the cash register.
2. Connect frame drawer connector (green lead on drawer) to the cash register.

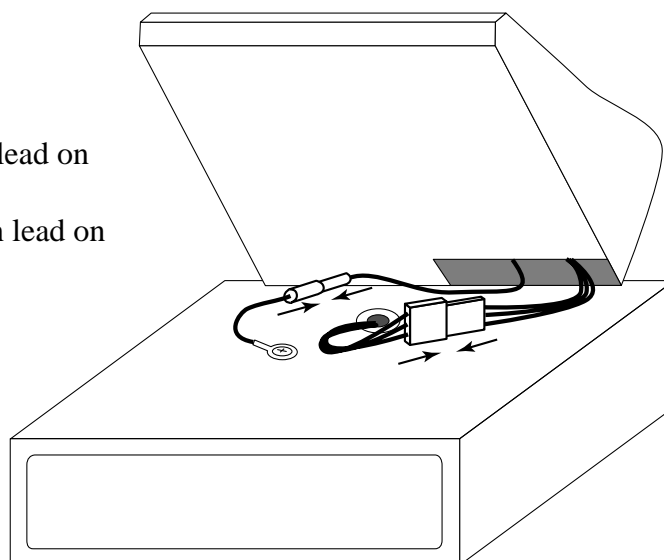

5. Mount the cash register.

1. Screw in 2 fixing screws bottom side of the register.
2. Stick rubber plate on the each corner of the bottom side of the register.
3. Mount the cash register on the top of the drawer, ensuring that the feet on the bottom of the cash register go into the holes on the drawer.

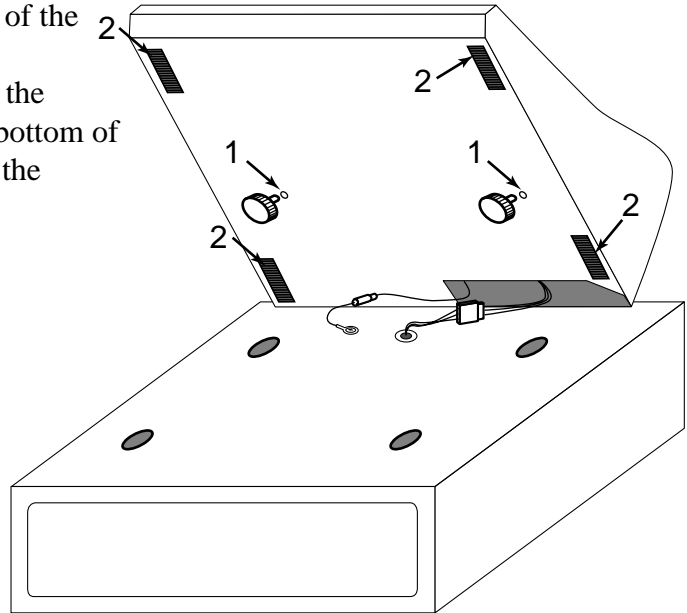

6. Plug the cash register into a wall outlet.

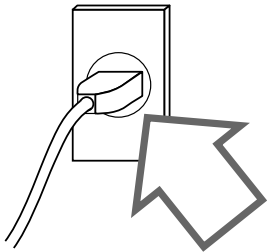

Be sure to check the sticker on the side of the cash register to make sure that its voltage matches that of the power supply in your area. The printer will operate for a few seconds. Please do not pass the power cable under the drawer.

7. Insert the mode key marked "OW" into the mode switch.

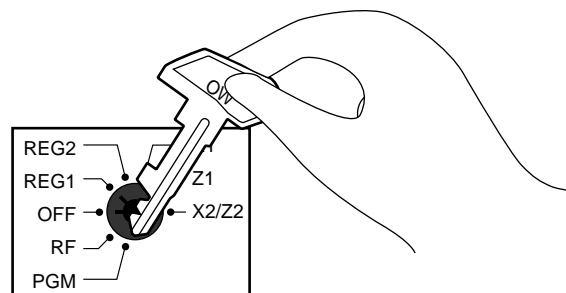

8. Install receipt/journal paper.

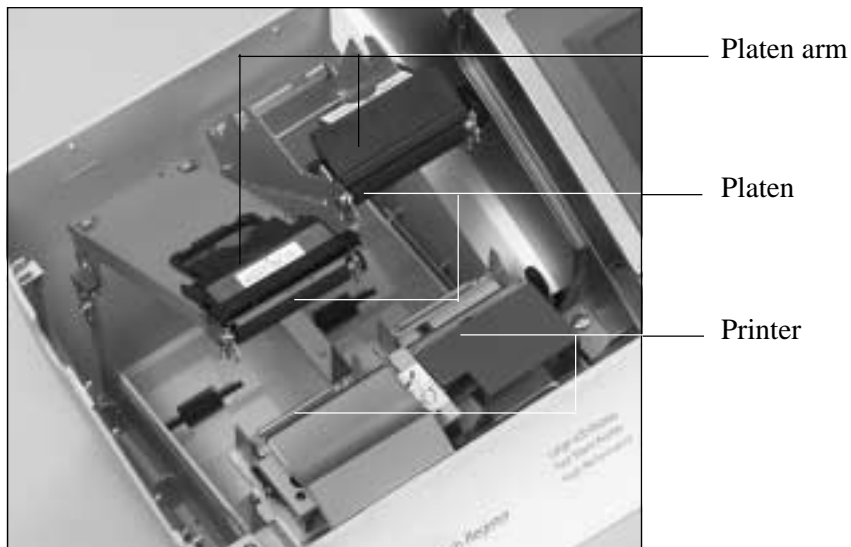

Important!

Take away the head protection sheet from the printer and close the platen arm.

Caution! (in handling the thermal paper)

- Never touch the printer head and the platen.
- Unpack the thermal paper just before your use.
- Avoid heat/direct sunlight.
- Avoid dusty and humid places for storage.
- Do not scratch the paper.
- Do not keep the printed paper under the following circumstances:
High humidity and temperature/direct sunlight/contact with glue, thinner or a rubber eraser.

To install receipt paper

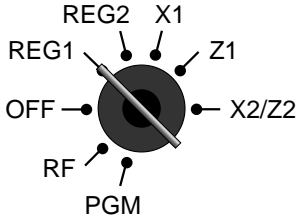

Step 1
Turn the mode switch to REG1 position.

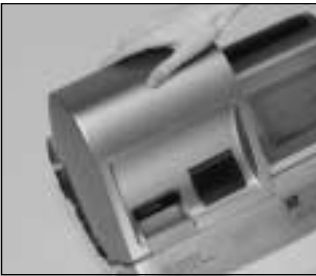

Step 2
Remove the printer cover.
(If the cover is locked, unlock by using the printer cover key before this step.)

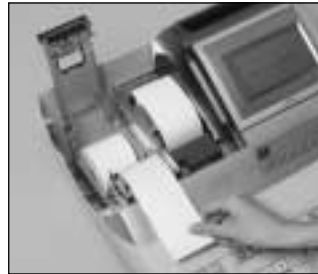

Step 5
Put the leading end of the paper over the printer.



Step 3
Open the platen arm.

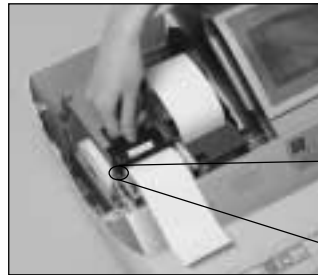

Step 6
Close the platen arm slowly until it locks steadily.

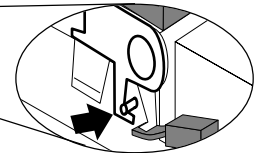

Locking platen



Step 4
Ensuring the paper is being fed from the bottom of the roll, lower the roll into the space behind the printer.



Complete
Close the printer cover, passing the leading end of the paper through the cutter slot.

To install journal paper

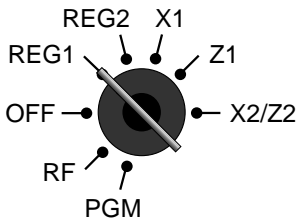

Step 1

Turn the mode switch to REG1 position.

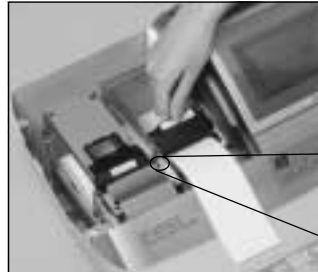

Step 6

Close the platen arm slowly until it locks steadily.

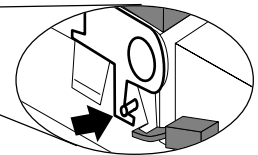

Locking platen

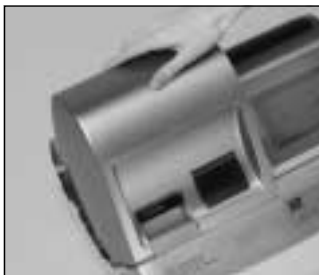

Step 2

Remove the printer cover. (If the cover is locked, unlock by using the printer cover key before this step.)



Step 7

Slide the leading end of the paper into the groove on the spindle of the take-up reel and wind it onto the reel two or three turns.



Step 3

Open the platen arm.



Step 8

Place the take-up reel into place behind the printer, above the roll paper.

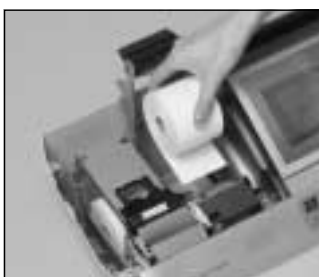

Step 4

Ensuring the paper is being fed from the bottom of the roll, lower the roll into the space behind the printer.



Step 9

Press the **JOURNAL FEED** key to take up any slack in the paper.

During machine installation, press the **JOURNAL FEED** key after power on.



Step 5

Put the leading end of the paper over the printer.



Complete

Close the printer cover.

9. Set the date.

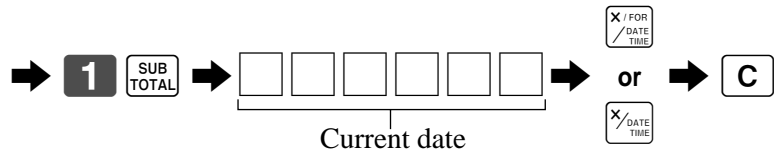
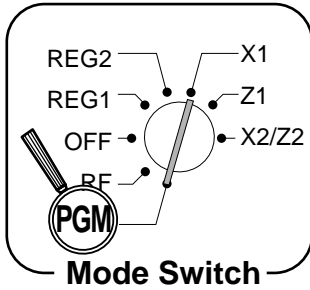

Example:

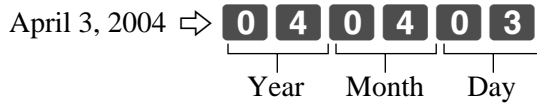

10. Set the time.

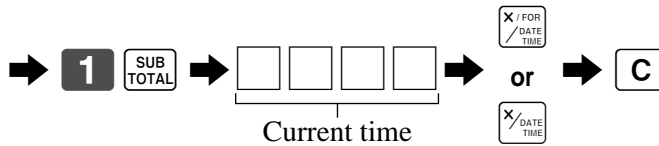
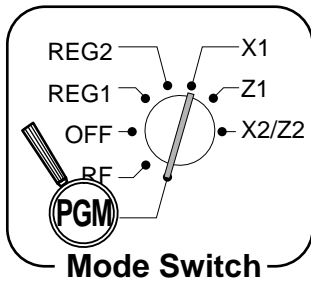

Example:

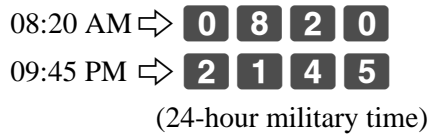

Introducing TE-3000S

General guide

This part of the manual introduces you to the cash register and provides a general explanation of its various parts.

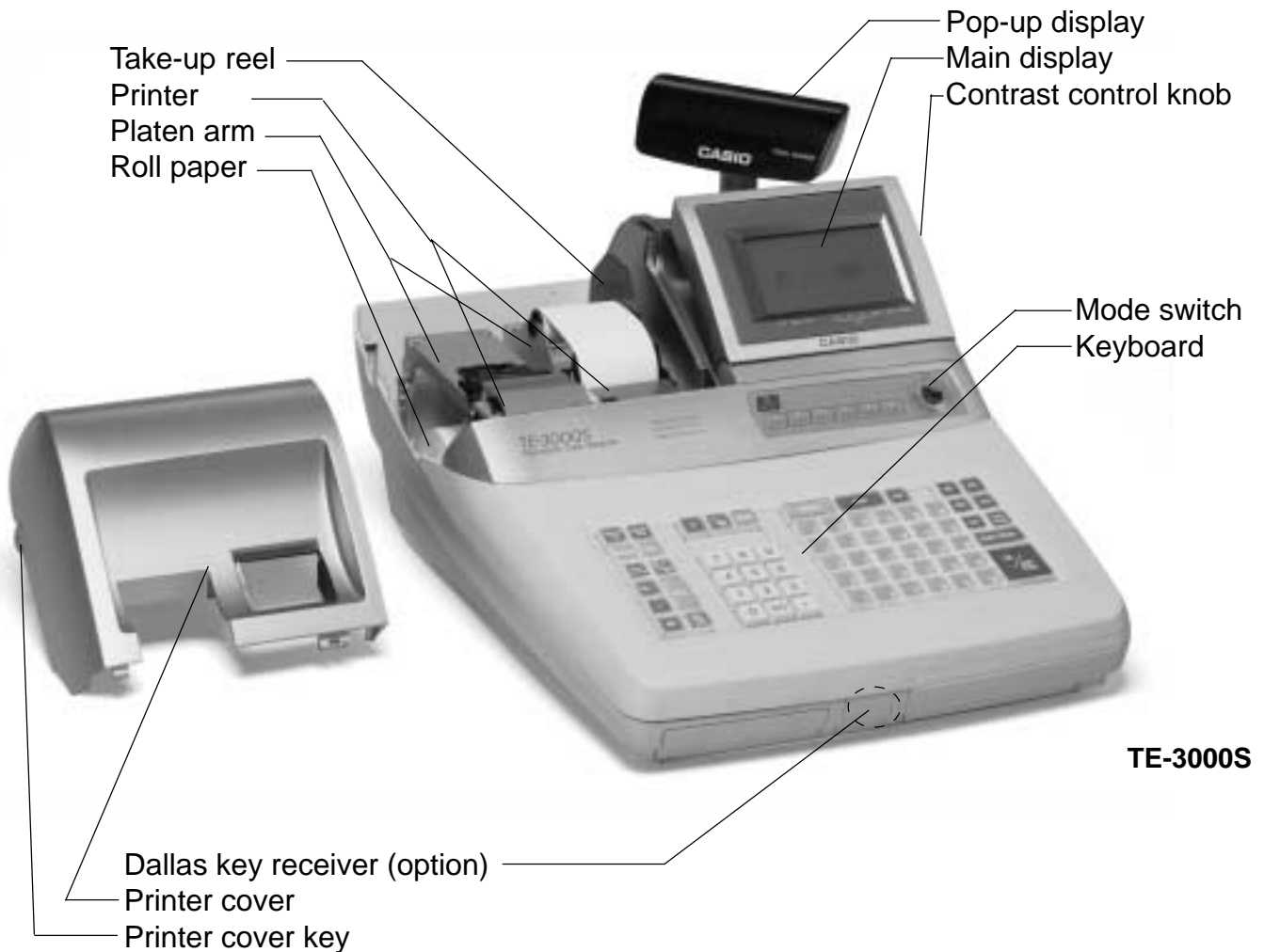

Roll paper

You can use the roll paper to print receipts and a journal (pages 12 ~ 14).

Receipt on/off switch / key

Use the receipt on/off switch/key in REG1, REG2 and RF modes to control issuance of receipts. In other modes, receipts or reports are printed regardless the receipt switch/key setting.

A post-finalization receipt can still be issued after finalization when the switch/key is set to off. The cash register can also be programmed to issue a post-finalization receipt even when the switch/key is set to on.

Receipt on/off switch

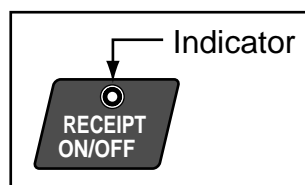

Receipt on/off key

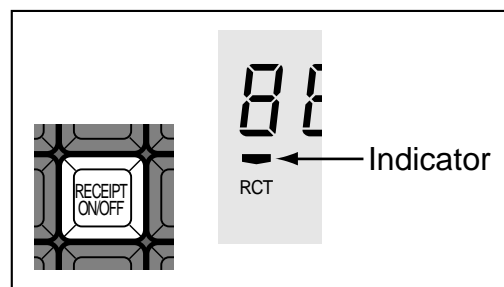

When the register issues receipts, this indicator is lit.

Mode key (for U.K., U.S. and Canada)

The following four types of mode keys are provided with the unit in the United Kingdom, the United States and Canada.

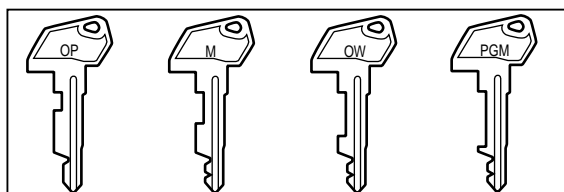

- a. OP (Operator) key
Switches between OFF and REG1.
- b. M (Master) key
Switches between OFF, REG1, REG2, X1 and RF.
- c. OW (Owner) key
Switches between OFF, REG1, REG2, X1, Z1, X2/
Z2 and RF.
- d. PGM (Program) key
Switches to any position.

Mode key (for other area)

The following three types of mode keys are provided with the unit in areas outside of the United Kingdom, the United States and Canada.

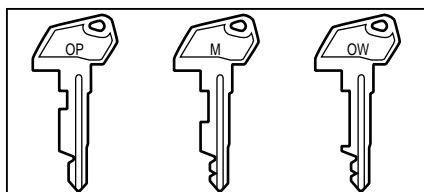

- a. OP (Operator) key
Switches between OFF and REG1.
- b. M (Master) key
Switches between OFF, REG1, REG2, X1 and RF.
- c. OW (Owner) key
Switches to any position.

Introducing TE-3000S

Mode switch

Use the mode keys to change the position of the mode switch and select the mode you want to use.

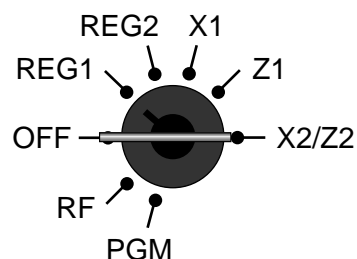

Mode switch	Mode name	Description
OFF	Stand-by	Any of the mode control keys can be inserted and removed from the mode switch in this position.
REG1	Register 1	Used for normal sales transactions. Any of the mode control keys can be inserted and removed from the mode switch in this position.
REG2	Register 2	Used for special operations. Since switching to REG2 requires a special key, such functions as discounts, credit sales, charge sales, check payments, and paid outs can be controlled by programming them as prohibited in REG1 and allowed in REG2.
RF	Refund Reg minus	Used for processing refunds. When the mode switch of the register is in RF position, you can access either the refund mode or the register minus mode.
X1	Daily sales read	Used to obtain daily reports without resetting (clearing) all total data.
Z1	Daily sales reset	Used to obtain daily reports while resetting (clearing) all total data.
X2/Z2	Periodic sale read/ reset	Used to obtain periodic sales reports without resetting total data or while resetting all total data.
PGM	Program	Used when programming functions and preset data such as unit prices and tax rates. Also used when reading program data.

Clerk key/button/lock

On models available in the United States, Canada and Germany, clerk or cashier assignment can be performed using clerk secret numbers only (clerk buttons are not equipped).

In other areas, you can assign clerks or cashiers by using clerk button or by clerk secret number. The method you are assigning clerk depends on the programming of your cash register.

Clerk secret number key

When the cash register is programmed to use clerk secret numbers for clerk or cashier assignment, the clerk buttons are not functional.

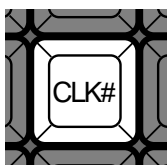

Clerk button

You can assign the clerk or cashier using the six buttons located below the display panel.

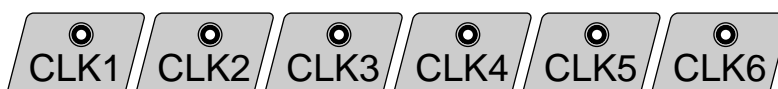

Drawer

The drawer opens automatically whenever you finalize a registration and whenever you issue a read or reset report.

Drawer lock (for medium size drawer)

Use the drawer key to lock and unlock the drawer.

Drawer open key (for large size drawer)

Use the drawer open key to open the drawer.

When the cash drawer does not open! (for medium size drawer only)

In case of power failure or the machine is in malfunction, the cash drawer does not open automatically. Even in these cases, you can open the cash drawer by pulling drawer release lever (see below).

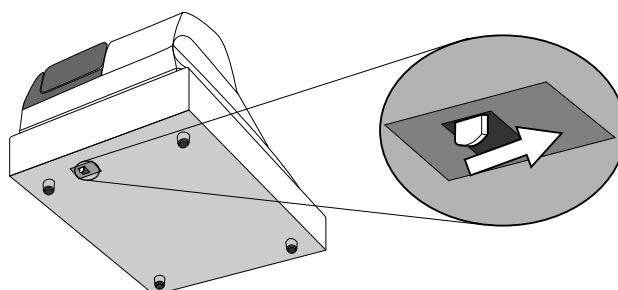

Important!

The drawer will not open, if it is locked with a drawer lock key.

Introducing TE-3000S

Display

Display panel

Main display



Customer display



Contrast control knob

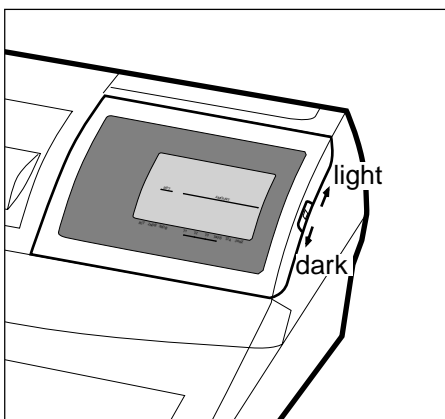

Tilt the LCD

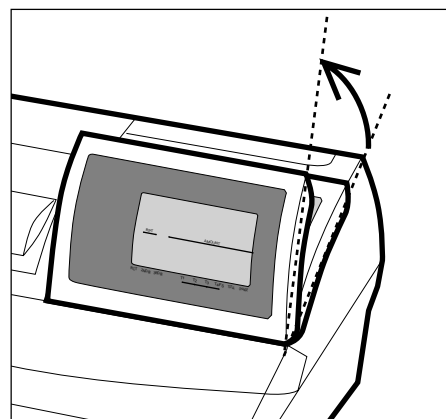

Backlight color control switch

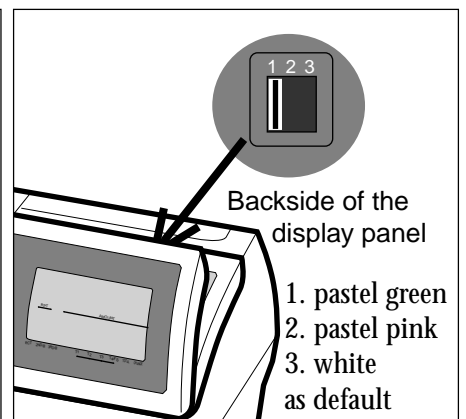

Display example

Item registration

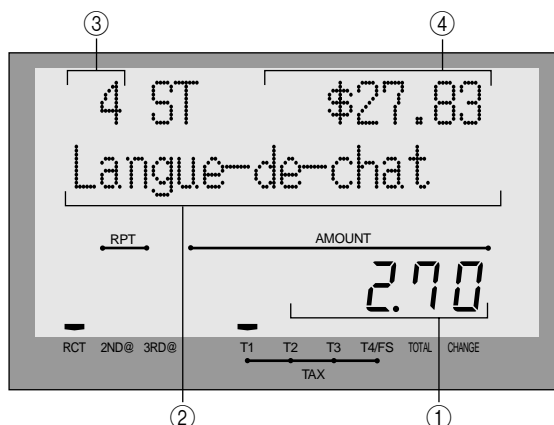

- ① **Amount/Quantity**
This part of the display shows monetary amounts. It also can be used to show the current time.
- ② **Item descriptor**
When you register a department/PLU/scanning PLU, the item descriptor appears here.
- ③ **Item counter**
Number of item sold is displayed.
- ④ **Subtotal amount**
Current subtotal amount (add-on tax excluded) is displayed.

Repeat registration

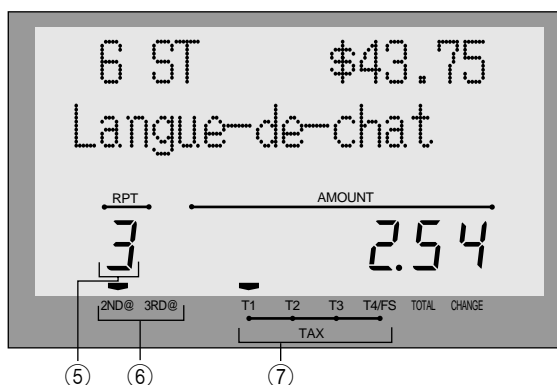

- ⑤ **Number of repeats**
Anytime you perform a repeat registration (pages 30, 35), the number of repeats appears here. Note that only one digit is displayed for the number of repeats. This means that a "5" could mean 5, 15 or even 25 repeats.
- ⑥ **2nd, 3rd menu indicator**
When you press PRICE SHIFT to designate the 2nd/3rd unit price, the corresponding number is displayed.
- ⑦ **Taxable sales status indicators**
When you register a taxable item, the corresponding indicator is lit.

Totalize operation

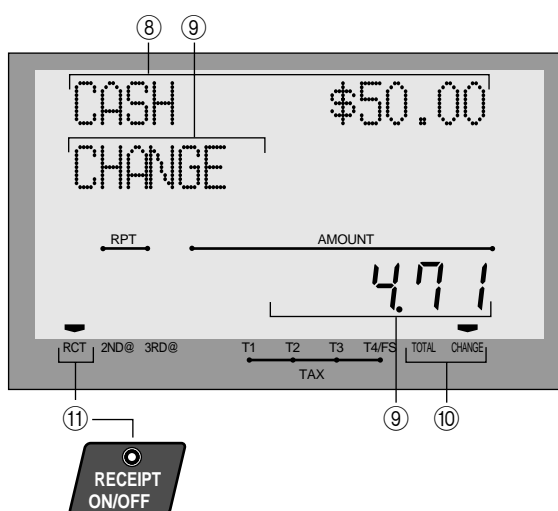

- ⑧ **Amount tendered key descriptor/amount**
- ⑨ **Change descriptor/amount**
- ⑩ **Total/Change indicators**
When the TOTAL indicator is lit, the displayed value is monetary total or subtotal amount. When the CHANGE indicator is lit, the displayed value is the change due.
- ⑪ **RCT indicator**
When the register issues receipts, this indicator is lit.

Introducing TE-3000S

Keyboard

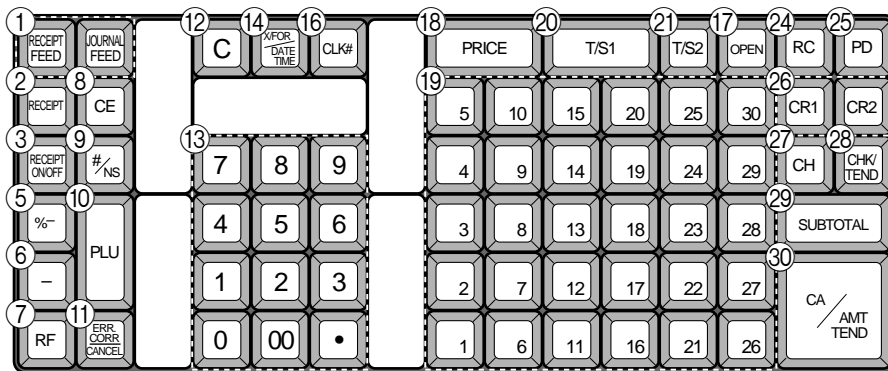

for the U.S. and Canada

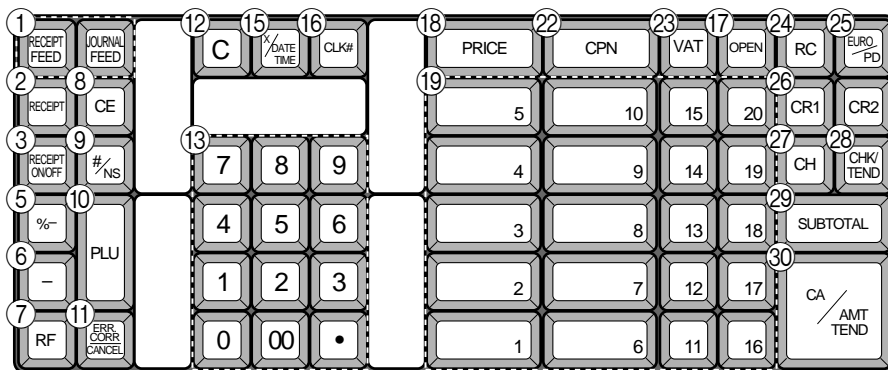

for German

• Register Mode

- ① **Paper feed key** ,
Hold this key down to feed paper from the printer.
- ② **Post receipt key**
Use this key to produce a post-finalization receipt .
- ③ **Receipt on/off key**
Use this key twice to change the status “receipt issue” or “no receipt.” This key is only effective when the “use printer for receipt printer” in the printer control program is selected. In case of “receipt issue”, the “RCT” indicator is lit.
- ④ **Media change key**
Use this key to change media in drawer amounts. Pressing this key enters media change operation.
- ⑤ **Discount key**
Use this key to register discounts.
- ⑥ **Minus key**
Use this key to input values for subtraction.
- ⑦ **Refund key**
Use this key to input refund amounts and void certain entries.
- ⑧ **Currency exchange key**
Use this key to convert foreign currency to local currency or vice versa using the exchange rate preset for the key and displays the result.
- ⑨ **Non-add/No sale key**
Non-add key: To print reference number (to identify a personal check, credit card, etc.) during a transaction, use this key after some numerical entries.
No sale key: Use this key to open the drawer without registering anything.
- ⑩ **PLU key**
Use this key to input PLU numbers.
- ⑪ **Error correction/cancellation key**
Use this key to correct registration errors and to cancel registration of entire transactions.
- ⑫ **Clear key**
Use this key to clear an entry that has not yet been registered.
- ⑬ **Ten key pad**
Use these keys to input numbers.
- ⑭ **Multiplication/For/Date/Time key**
Use this key to input a quantity for a multiplication operation and registration of split sales of packaged items. Between transactions, this key displays the current time and date.

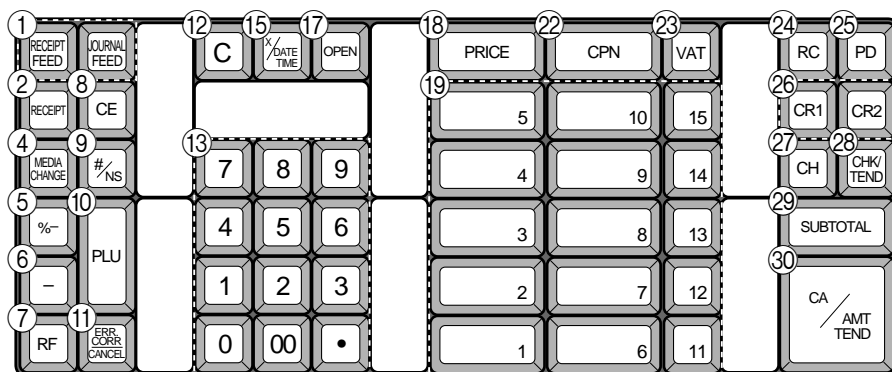

for the U.K.

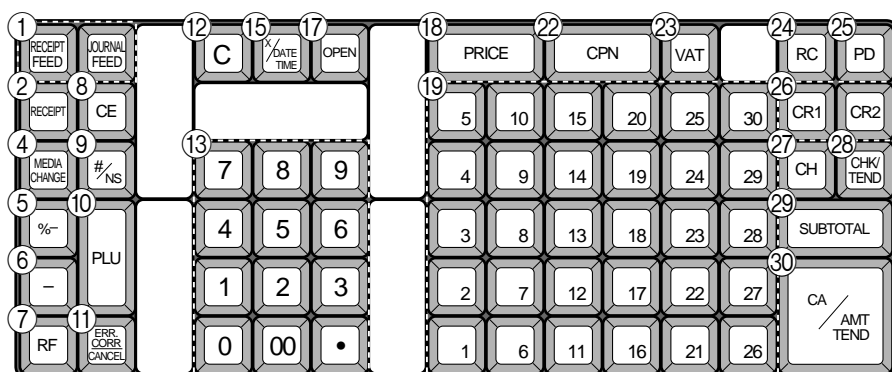

for other area

- ⑮ **Multiplication/Date/Time key**
 Use this key to input a quantity for a multiplication operation. Between transactions, this key displays the current time and date.
- ⑯ **Clerk number key**
 Use this key to sign clerk on and off the register.
- ⑰ **Open key**
 Use this key to temporarily release a limitation on the number of digits that can be input for a unit price.
- ⑱ **Price key**
 Use this key to register an amount to an open PLU when a PLU is used as an open PLU.
- ⑲ **Department keys** , , ~
 Use these keys to register items to departments.
- ⑳ **Tax status shift 1 key**
 Use this key to change the Taxable 1 status of the next item.
- ㉑ **Tax status shift 2 key**
 Use this key to change the Taxable 2 status of the next item.
- ㉒ **Coupon key**
 Use this key to register coupon. The registered coupon amount is deducted from the department, PLU, gross and net totalizers.
- ㉓ **VAT key**
 Use this key to print a VAT breakdown.
- ㉔ **Received on account key**
 Use this key following a numeric entry to register money received for non-sale transactions.
- ㉕ **Paid out key**
 Use this key following a numeric entry to register money paid out from the drawer.
 Except for the U.S. and Canada, use this key to convert the main currency to the sub currency (the euro/the local money), when registering a subtotal amount. This key is also used for specifying sub currency while entering an amount of payment or declaration in drawers.
- ㉖ **Credit key** ,
 Use this key to register a credit sale.
- ㉗ **Charge key**
 Use this key to register a charge sale.
- ㉘ **Check key**
 Use this key to register a check tender.
- ㉙ **Subtotal key**
 Use this key to display and print the current subtotal (includes add-on tax) amount.
- ㉚ **Cash/Amount tendered key**
 Use this key to register a cash tender.

Allocatable functions

You can tailor a keyboard to suit your particular type of business.

Add check

Use this key in a check tracking system to combine the details of more than one check into a single check.

Arrangement

Use this key to activate an arrangement program programmed in the arrangement file. Any operation that can be performed from the keyboard, as well as mode, can be programmed in an arrangement program, and can be performed merely by pressing this key. In addition, one numeric entry can be included in an arrangement program. In this case, input the number and press this key.

The mode control function of this key can be programmed for all modes except for the OFF and PGM mode.

Bill copy

Use this key to issue bill copy.

Bottle return

Use this key to specify next item as bottle return.

Cancel

Invalidates all preceding data registered for departments, PLUs and set menus within a transaction. This key must be pressed before the transaction involving the data to be invalidated is finalized. It is also effective even after calculation of subtotal amount.

Check endorsement

Use this key to print a preset check endorsement message using the slip printer.

Check print

Use this key to print the check on the slip printer.

Clerk transfer

Use this key to transfer opened checks to another clerk.

Clock-in/-out

Use this key to register the time when the employees start/finish their job.

Coupon 2

Use this key to declare the next item registration as coupon.

Cube

This key provides the same functions as the Square key. In addition, this key also has a cube multiplication function.

Customer number

Use this key to register the number of customers.

Declaration

Use this key to declare in drawer amount for money declaration.

Deposit

Use this key to register deposits.

Eat-in

Use this key to specify if the customer eats in the restaurant. Before closing a transaction press this key.

EBT (electronic benefit transfer)

Use this key to register an EBT amount with a tender amount input.

Flat PLU

Use this key to register items to flat PLU.

Food stamp shift

Use this key to change food stamp status.

Food stamp subtotal

Use this key to obtain the food stamp applicable amount.

Food stamp tender

Use this key to register a food stamp payment amount with a tender amount input.

Ketten Bon

Use this key to enter quantities for multiplication. Multiplication by this key issues singular order prints.

Loan

Use this key to input the amount of money provided for making change. This operation affects media totals, rather than sales totals. Loans are made for all types of money which can be specified by the finalize key.

Manual tax

Use this key to register a tax amount.

Menu shift

Use this key to shift key to the 1st ~ 6th menu.

Merchandise subtotal

Use this key to obtain subtotal excluding the add-on tax amount and the previous balance.

New balance

Use this key for adding the latest registered total amount to the previous balance to obtain a new balance.

New check

Use this key in a check tracking system to input a new check number in order to open a new check under that number.

New/Old check

Use this key in a check tracking system to input check numbers in order to open new checks and to reopen existing checks. When the clerk inputs a check number, the register checks to see if that number already exists in the check tracking memory. If there is no matching number in the memory, a new check is opened under the input number. If the check number input matches a number already stored in the memory, that check is reopened for further registration or finalization.

No sale

Use this key to open the drawer between transaction.

Non add

Use this key to print reference numbers (personal check number, card number, etc.)

Normal receipt

Use this key to change the order status from Bon to normal.

OBR (Optical barcode reader)

Use this key to input optical barcodes manually.

Old check

Use this key in a check tracking system to input the number of an existing check (previously created by the New check key) whose details are stored in the check tracking memory. Existing checks are reopened to perform further registration or to finalize them.

One touch NLU

Use this key to register scanning PLU directly from the keyboard. There is one One touch NLU key for one scanning PLU, and multiple one touch NLU keys can be set on the keyboard.

Open 2

Use this key to suspend the compulsory specifications.

Open check

Use this key to issue an open check report of an assigned clerk.

Operator number

Use this key to enter a clerk number during clerk transfer.

Operator X/Z

Use this key to issue a clerk's individual X/Z report.

Pick up

When the amount in drawer exceeds the limit value (sentinel function), the manager performs a pick up operation. This key is used for this function. This operation affects media totals, rather than sales totals. Pick ups are made for all types of money which can be specified by the finalize key.

Plus

Use this key for registering surcharge.

Premium

Use this key to apply a preset % or manual input % to obtain the premium amount for the last registered item or subtotal.

Previous balance

Use this key to register the previous negative/positive balance at the beginning of or during a transaction.

Previous balance subtotal

Use this key to obtain subtotal excluding the add-on tax amount and current balance.

Price change

Use this key to change scanning PLU unit price temporarily.

Price inquiry

Use this key to confirm the price and descriptors of PLU without registering.

Price shift

Use this key to shift a PLU item/flat-PLU key to the 1st ~ 2nd unit price, a scanning PLU to the 1st ~ 3rd unit price.

Rate tax

Use this key to activate the preset tax rate or manually input rate to obtain the tax for the preceding taxable status 1 amount.

Recall

Use this key for recalling the transferred check number by the store key. When this key is pressed, the check number will appear in order of the oldest record.

Red price

Use this key to register a new (discounted) price of an item.

Review

Use this key to examine the current transaction by displaying item descriptor and registered amount. This key is also used for void operation or separate check operation.

Scale

Use this key to read the weight of the item and shows it on the display. This key is also used to input the weight manually.

Separate check

Use this key in a check tracking system to separate selected items from one check to another check.

Slip feed/release

Use this key to feed slips inserted into the slip printer. This is done by specifying the number of feed lines. This key is also used to release the slip paper holder if numbers are not entered.

Slip back feed/release

Use this key to back feed slips inserted into the slip printer. This is done by specifying the number of feed lines. This key is also used to release the slip paper holder if numbers are not entered.

Slip print

Use this key to execute a slip batch printing on the slip printer. Pressing this key prints the sales details. Actual printing is performed following receipt issuance.

Square

This key provides the same functions as the Multiplication key. In addition, this key also has a square multiplication function.

Stock inquiry

Use this key to check the current stock quantity for a PLU without registering.

Store

Use this key for storing the check number of the registered items. When this key is pressed, registered item data will be stored, and then these data will transfer to the youngest check number.

Table number

Use this key to input table numbers.

Table transfer

Use this key to transfer the contents of a check to another check.

Takeout

Use this key to specify if the customer takes out items. Before total a transaction. Press this key for the tax exemption.

Tare

Use this key to input tare weight.

Tax exempt

Use this key to change taxable amounts to nontaxable amounts.

Taxable amount subtotal

Use this key to obtain taxable amount subtotal.

Text print

Use this key to enter characters to print.

Text recall

Use this key to print preset characters.

Tip

Use this key to register tips.

Tray total

Use this key to display the total amount for all registrations from the last registration until this key is pressed or registrations between presses of this key.

Unit weight

Use this key to input the unit weight of a scalable item.

Validation

Use this key to validate transaction amounts on slip.

Void

Use this key to invalidate preceding item data registered.

How to read the printouts

- The journal and receipts are records of all transactions and operations.
- The contents printed on receipts and journal are almost identical.
- You can choose the journal skip function.

If the journal skip function is selected, the cash register will print the total amount of each transaction, and the details of premium, discount and reduction operations only, without printing department and PLU item registrations on the journal.

- The following items can be skipped on receipts and journal.
 - Consecutive number
 - Taxable status
 - Taxable amount
 - Item counter

Receipt Sample

***** * THANK YOU * ** CALL AGAIN ** *****	Logo message
* COMMERCIAL MESSAGE * * COMMERCIAL MESSAGE * * COMMERCIAL MESSAGE * * COMMERCIAL MESSAGE *	Commercial message
REG 03-06-2000(SAT) 11:58 C01 MC#01 000123	Mode/Date/Time Clerk/Machine No. Consecutive No.
1 DEPT01 T1 -1.00 1 DEPT02 T1 -2.00 5 DEPT03 -5.00	Q'ty/Item
7 No	Item counter
TA1 -3.00 TX1 -0.15 TL -8.15 CASH -10.00 CG -1.85	
*** BOTTOM MESSAGE *** *** BOTTOM MESSAGE *** *** BOTTOM MESSAGE *** *** BOTTOM MESSAGE ***	Bottom message

**Journal Sample
(Item lines Included)**

REG 03-06-2000(SAT) 11:58 C01 MC#01 000123
1 DEPT01 T1 -1.00 1 DEPT02 T1 -2.00 5 DEPT03 -5.00
7 No
TA1 -3.00 TX1 -0.15 TL -8.15 CASH -10.00 CG -1.85
REG 03-06-2000(SAT) 11:59 C01 MC#01 000124
1 DEPT01 T1 -1.00 1 DEPT12 T1 -1.00 5 DEPT03 -6.00
7 No
TA1 -2.00 TX1 -0.10 TL -8.10 CASH -10.00 CG -1.90
REG 03-06-2000(SAT) 11:59 C01 MC#01 000124

**Journal Sample
(Item lines Skipped)**

REG 03-06-2000(SAT) 11:58 C01 MC#01 000123
1 DEPT01 T1 -1.00 1 DEPT02 T1 -2.00 5 DEPT03 -5.00
7 No
TA1 -3.00 TX1 -0.15 TL -8.15 CASH -10.00 CG -1.85
REG 03-06-2000(SAT) 11:59 C01 MC#01 000124
1 DEPT01 T1 -1.00 1 DEPT12 T1 -1.00 5 DEPT03 -6.00
7 No
TA1 -2.00 TX1 -0.10 TL -8.10 CASH -10.00 CG -1.90
REG 03-06-2000(SAT) 11:59 C01 MC#01 000125

In the operation examples contained in this manual, the print samples are what would be produced if the roll paper is being used for receipts. They are not actual size. Actual receipts are 58 mm wide. Also, all sample receipts and journals are printout images.

How to use your cash register

The following describes the general procedure you should use in order to get the most out of your cash register.

BEFORE business hours...

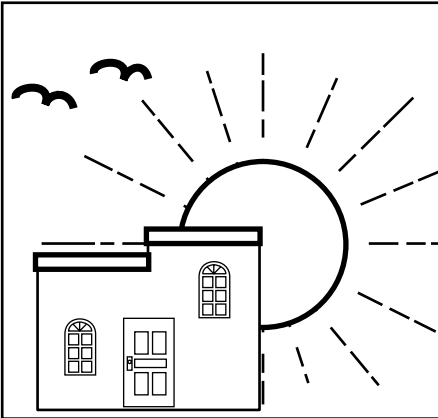

- Check to make sure that the cash register is plugged in securely. Page 11
- Check to make sure there is enough paper left on the roll. Pages 13, 14
- Read the financial totals to confirm that they are all zero. Page 99
- Check the date and time. Page 29

DURING business hours...

- Register transactions. Page 30
- Periodically read totals. Page 98

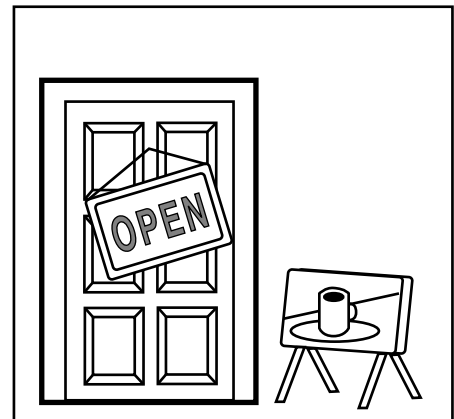

AFTER business hours...

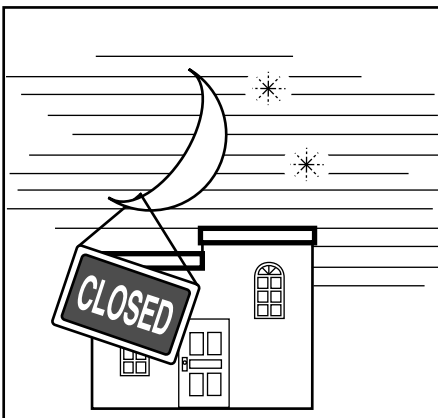

- Reset the daily totals. Page 50
- Remove the journal. Page 114
- Empty the cash drawer and leave it open. Page 19
- Take the cash and journal to the office.

Basic Operations and Setups

Assigning a clerk

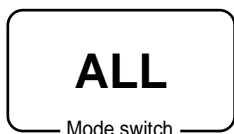

On models available in the United States and Canada, clerk or cashier assignment can be performed using clerk secret numbers only (clerk buttons are not equipped). In Germany, you can assign clerks by using clerk key or by clerk secret number (clerk key is equipped). In other areas, you can assign clerks by using clerk button or by clerk secret number. The method you use for assigning clerk depends on the programming of your cash register.

Clerk button

You can assign the clerk or cashier using the six buttons located below the display panel.

Clerk lock/clerk key

You can assign the clerk or cashier by inserting a clerk key into the clerk lock.

Clerk secret number key

When the cash register is programmed to use clerk secret numbers for clerk or cashier assignment, the clerk buttons are not functional.

Clerk sign on

	OPERATION	RECEIPT
Signing clerk 1 on:	1 → <input type="button" value="CLK#"/>	<pre>* COMMERCIAL MESSAGE * REG 03-06-2000(SAT) 11:58 C01 MC#01 000123 Clerk name/machine No./consecutive No. 1 DEPT01 T1 -1.00</pre>
Signing clerk 2 on:	2 → <input type="button" value="CLK#"/>	
...	...	
Signing clerk 15 on:	1 5 → <input type="button" value="CLK#"/>	

Clerk secret number
(1 ~ 15 is set as default.)

- If you do not want the clerk secret number to be shown on the display, press before entering the number.

Clerk sign off

	OPERATION
Signing clerk off: (except PGM mode)	0 → <input type="button" value="CLK#"/>

- The current clerk is also signed off whenever you set the mode switch to OFF position.

Important!

- The error code "E008" appears on the display whenever you try to perform a registration, a read/reset operation without signing on.
- A clerk cannot sign on unless other clerk is signed off.
- The signed on clerk is also identified on the receipt/journal.

Displaying the time and date

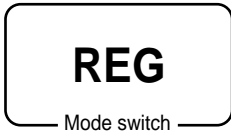

You can show the time or date on the display of the cash register whenever there is no registration being made.

To display and clear the date/time

OPERATION

DISPLAY

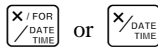

Date/time appears on the display.

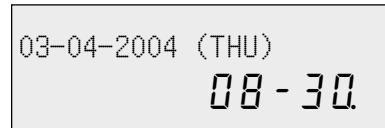

Clears the date/time display.



Preparing coins for change



You can use the following procedure to open the drawer without registering an item. This operation must be performed out of a sale. (You can use the **RC** key instead of the **#/NS** key. See page 45.)

Opening the drawer without a sale

OPERATION

RECEIPT



Preparing and using department keys

Registering department keys



The following examples show how you can use the department keys in various types of registrations.

Single item sale

Example 1

OPERATION

RECEIPT

Item	Unit price	\$1.00
	Quantity	1
	Dept.	1
Payment	Cash	\$1.00

1 00
Unit price

1 DEPT01	.1.00	Department No./ unit price Total amount
TL	- 1.00	
CASH	.1.00	

1

Department

CA/AMT
TEND

Example 2 (Subtotal registration and change computation)

OPERATION

RECEIPT

Item	Unit price	\$12.34
	Quantity	1
	Dept.	1
Payment	Cash	\$20.00

1 2 3 4
Unit price

1 DEPT01	.12.34	Total amount Amount tendered Change
TL	- 12.34	
CASH	.20.00	
CG	.7.66	

1

Department

SUB
TOTAL

2 0 00 CA/AMT
TEND

Amount tendered

Repeat

OPERATION

RECEIPT

Item	Unit price	\$1.50
	Quantity	3
	Dept.	1
Payment	Cash	\$10.00

1 5 0 **1**

1 DEPT01	.1.50	Repeat
1 DEPT01	.1.50	
1 DEPT01	.1.50	Repeat
TL	- 4.50	
CASH	.10.00	
CG	.5.50	

1

1

1

SUB
TOTAL

1 0 00 CA/AMT
TEND

Multiplication

Item	Unit price	\$1.00
	Quantity	12
	Flat-PLU	1
Payment	Cash	\$20.00

OPERATION

1 2 /FOR DATE TIME

Quantity
(4-digit integer/2-digit decimal)

1 00 /FOR DATE TIME

001 /FOR DATE TIME

SUB TOTAL

2 0 00 CA/AMT TEND

12 PLU0001	· 12.00	Quantity/result or Quantity/unit q'ty/@ Result
12X @1/ 1.00 PLU0001	· 12.00	
TL	- 12.00	
CASH	· 20.00	
CG	· 8.00	

- The model for the U.S./Canada, use /FOR DATE TIME instead of /DATE TIME.

Split sales of packaged items

Item	Unit price	4 for \$10.00
	Quantity	3
	Dept.	1
	Taxable	No
Payment	Cash	\$10.00

OPERATION

3 /FOR DATE TIME

Quantity being purchased
(4-digit integer/2-digit decimal)

4 /FOR DATE TIME

Package quantity
(4-digit integer/2-digit decimal)

1 0 00 /FOR DATE TIME

1 /FOR DATE TIME

Package price **SUB TOTAL**

1 0 00 CA/AMT TEND

3 DEPT01	· 7.50	Quantity/result or Quantity/unit q'ty/@ Result
3X @4/ 10.00 DEPT01	· 7.50	
TL	- 7.50	
CASH	· 10.00	
CG	· 2.50	

- If /FOR DATE TIME is not allocated on the keyboard, key allocation is necessary.

Programming department keys

To program a unit price for each department

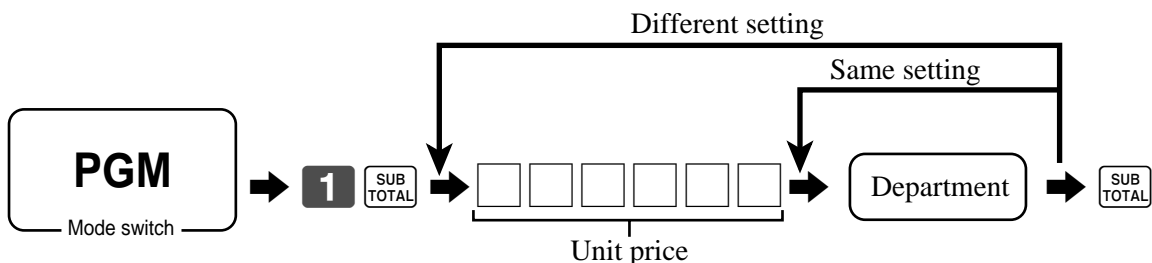

To program the tax calculation status for each department

Tax calculation status

This specification defines which tax table should be used for automatic tax calculation.

Basic Operations and Setups

Programming procedure

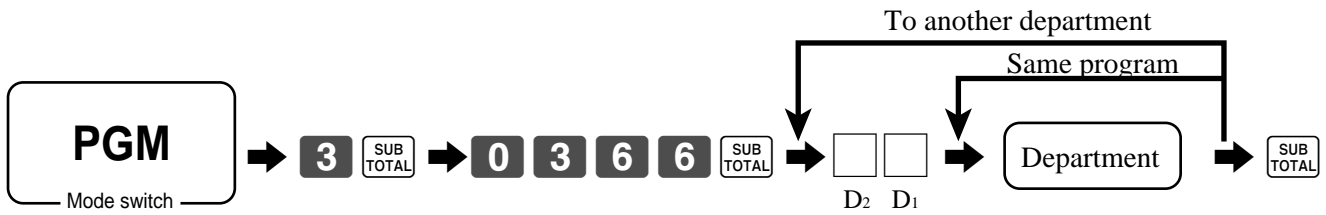

Description	Choice	Program code
-------------	--------	--------------

for the U.S. / Singapore

Food stamp (for Singapore, always "0".)	Yes = 1 No = 0	<input type="checkbox"/> D ₂
Taxable 1 status	a Yes = 1 No = 0	a+b+c <input type="checkbox"/> D ₁
Taxable 2 status	b Yes = 2 No = 0	
Taxable 3 status	c Yes = 4 No = 0	

for Canada

Donuts status	Yes = 1 No = 0	<input type="checkbox"/> D ₂
Non tax = 0 Taxable 3 = 3 Taxable 1 & 3 = 6 Taxable 1 = 1 Taxable 4 = 4 Taxable 1 & 4 = 7 Taxable 2 = 2 Taxable 1 & 2 = 5	Significant number	<input type="checkbox"/> D ₁

for other area

Non tax = 0 Taxable 4 = 4 Taxable 8 = 8 Taxable 1 = 1 Taxable 5 = 5 Taxable 9 = 9 Taxable 2 = 2 Taxable 6 = 6 Taxable 10 = 10 Taxable 3 = 3 Taxable 7 = 7	Significant numbers	<input type="checkbox"/> <input type="checkbox"/> D ₂ D ₁
---	---------------------	---

To program high amount limit for each department

Programming procedure

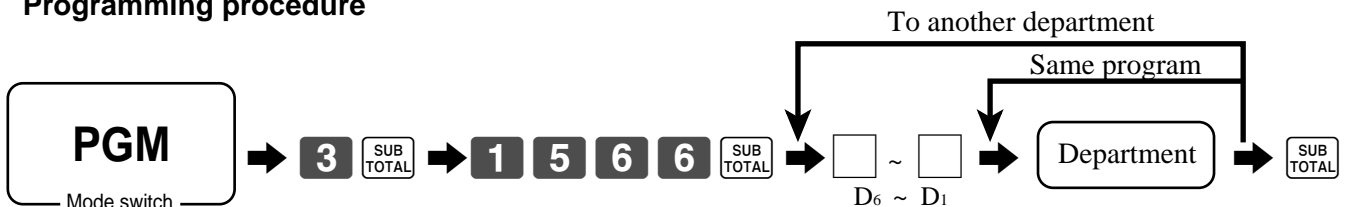

Description	Choice	Program code
High amount limit for entering unit price manually.	Significant numbers	<input type="checkbox"/> ~ <input type="checkbox"/> D ₆ ~ D ₁

Registering department keys by programming data



Preset price

Item	Unit price	(\$1.00) _{preset}
	Quantity	1
	Dept.	2
Payment	Cash	\$1.00

OPERATION

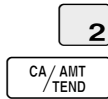

RECEIPT

1 DEPT02		.1.00	Department No./ unit price
TL	-	1.00	
CASH		.1.00	

Preset tax status

Item 1	Unit price	(\$2.00) _{preset}
	Quantity	5
	Dept.	3
	Taxable	(1) _{preset}
Item 2	Unit price	(\$2.00) _{preset}
	Quantity	1
	Dept.	4
	Taxable	(2) _{preset}
Payment	Cash	\$20.00

OPERATION

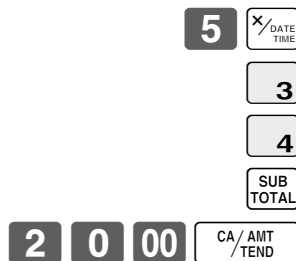

RECEIPT

5 DEPT03	T1	.10.00	Tax status
1 DEPT04	T2	.2.00	
TA1		.10.00	Taxable Amount 1
TX1		.0.40	Tax 1
TA2		.2.00	Taxable Amount 2
TX2		.0.20	Tax 2
TL		-12.60	
CASH		.20.00	
CG		.7.40	

- The model for the U.S./Canada, use FOR DATE TIME instead of DATE TIME.

Locking out high amount limitation

Item	Unit price	\$1.05
	Quantity	1
	Dept.	3
	Max.amount	(\$10.00) _{preset}
Payment	Cash	\$2.00

OPERATION

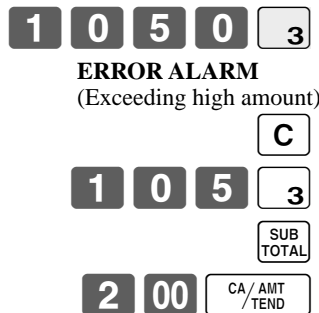

RECEIPT

1 DEPT03		.1.05
TL	-	1.05
CASH		.2.00
CG		.0.95

Preparing and using PLUs

This section describes how to prepare and use PLUs.

CAUTION:

Before you use PLUs, you must first program the unit price and tax status.

Programming PLUs

To program a unit price for each PLU

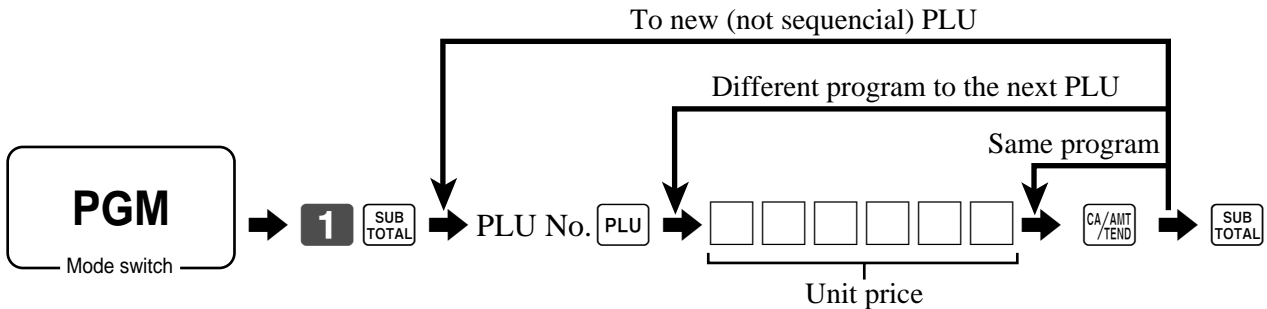

To program tax calculation status for each PLU

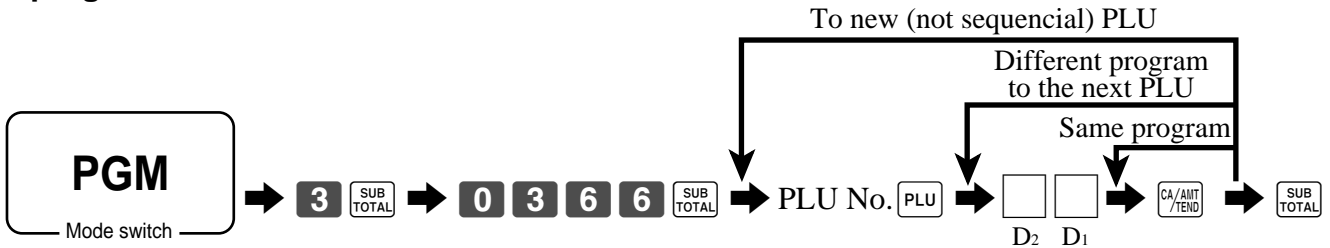

Description	Choice	Program code
-------------	--------	--------------

for the U.S. / Singapore

Food stamp (for Singapore, always "0").	Yes = 1 No = 0	<input type="checkbox"/> D ₂
Taxable 1 status	a Yes = 1 No = 0	a+b+c <input type="checkbox"/> D ₁
Taxable 2 status	b Yes = 2 No = 0	
Taxable 3 status	c Yes = 4 No = 0	

for Canada

Donuts status	Yes = 1 No = 0	<input type="checkbox"/> D ₂
Non tax = 0 Taxable 1 = 1 Taxable 2 = 2	Taxable 3 = 3 Taxable 4 = 4 Taxable 1 & 2 = 5	Significant number <input type="checkbox"/> D ₁
	Taxable 1 & 3 = 6 Taxable 1 & 4 = 7	

for other area

Non tax = 0 Taxable 1 = 1 Taxable 2 = 2 Taxable 3 = 3	Taxable 4 = 4 Taxable 5 = 5 Taxable 6 = 6 Taxable 7 = 7	Taxable 8 = 8 Taxable 9 = 9 Taxable 10 = 10	Significant numbers <input type="checkbox"/> <input type="checkbox"/> D ₂ D ₁
--	--	---	---

Registering PLUs

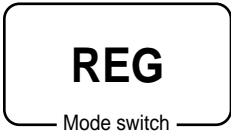

The following examples show how you can use PLUs in various types of registrations.

PLU single item sale

Item	Unit price	(\$2.50) _{preset}
	Quantity	1
	PLU	14
Payment	Cash	\$3.00

OPERATION

1 4
 PLU code
PLU
SUB
TOTAL
3 00 CA/AMT
TEND

RECEIPT

1 PLU0014	·2.50	PLU No./unit price
TL	- 2.50	
CASH	·3.00	
CG	·0.50	

PLU repeat

Item	Unit price	(\$2.50) _{preset}
	Quantity	3
	PLU	14
Payment	Cash	\$10.00

OPERATION

1 4 PLU
PLU
PLU
SUB
TOTAL
1 0 00 CA/AMT
TEND

RECEIPT

1 PLU0014	·2.50
1 PLU0014	·2.50
1 PLU0014	·2.50
TL	- 7.50
CASH	·10.00
CG	·2.50

PLU multiplication

Item	Unit price	(\$2.00) _{preset}
	Quantity	10
	PLU	7
Payment	Cash	\$20.00

OPERATION

1 0 X/DATE
Quantity
 (4-digit integer/2-digit decimal)
7 PLU
SUB
TOTAL
2 0 00 CA/AMT
TEND

RECEIPT

10 PLU0007	·20.00	Quantity/result or Quantity/unit q'ty/@ Result
10X @1/ 2.00		
PLU0007	·20.00	
TL	- 20.00	
CASH	·20.00	
CG	·0.00	

- The model for the U.S./Canada, use X/DATE instead of X/GATE.

Basic Operations and Setups

Split sales of packaged item

Item	Unit price	(5for\$20.00) <small>preset</small>
	Quantity	3
	PLU	28
Payment	Cash	\$15.00

OPERATION

3 X / FOR
DATE
TIME
 Quantity being purchased
 (4-digit integer/2-digit decimal)

5 X / FOR
DATE
TIME
 Package quantity
 (4-digit integer/2-digit decimal)

2 8 PLU

SUB
TOTAL

1 5 00 CA / AMT
TEND

RECEIPT

3 PLU0028	· 12.00	Quantity/result
3X @5/ 20.00		or
PLU0028	· 12.00	Quantity/unit q'ty/@
TL	· 12.00	Result
CASH	· 15.00	
CG	· 3.00	

- If X / FOR
DATE
TIME is not allocated on the keyboard, key allocation is necessary.

Open PLU

Item 1	Unit price	\$32.80
	Quantity	1
	PLU	30
Item 2	Unit price	\$13.00
	Quantity	2
	PLU	31
Payment	Cash	\$60.00

OPERATION

3 0 PLU
3 2 8 0 PRICE
 Unit price

3 1 PLU
1 3 00 PRICE
 Repeat PRICE

SUB
TOTAL

6 0 00 CA / AMT
TEND

RECEIPT

1 PLU0030	· 32.80	
1 PLU0031	· 13.00	
1 PLU0031	· 13.00	
TL	· 58.80	
CASH	· 60.00	
CG	· 1.20	

- Before registering an open PLU, it is necessary to preset it as an open PLU.

Shifting the taxable status of an item

By pressing “Tax Shift” key, you can shift the taxable status of an item.



Calculation merchandise subtotal

			OPERATION	RECEIPT																																	
Item 1	Dept. 1	\$4.00	4 00 1	<table style="width: 100%; border-collapse: collapse;"> <tr><td>1 DEPT01</td><td>T2</td><td style="text-align: right;">-4.00</td></tr> <tr><td>1 DEPT02</td><td>T1</td><td style="text-align: right;">-2.00</td></tr> <tr><td>1 DEPT03</td><td>T12</td><td style="text-align: right;">-6.00</td></tr> <tr><td>1 DEPT04</td><td></td><td style="text-align: right;">-7.00</td></tr> <tr><td>TA1</td><td></td><td style="text-align: right;">-8.00</td></tr> <tr><td>TX1</td><td></td><td style="text-align: right;">-0.32</td></tr> <tr><td>TA2</td><td></td><td style="text-align: right;">-10.00</td></tr> <tr><td>TX2</td><td></td><td style="text-align: right;">-0.50</td></tr> <tr><td>TL</td><td></td><td style="text-align: right;">-19.82</td></tr> <tr><td>CASH</td><td></td><td style="text-align: right;">-20.00</td></tr> <tr><td>CG</td><td></td><td style="text-align: right;">-0.18</td></tr> </table>	1 DEPT01	T2	-4.00	1 DEPT02	T1	-2.00	1 DEPT03	T12	-6.00	1 DEPT04		-7.00	TA1		-8.00	TX1		-0.32	TA2		-10.00	TX2		-0.50	TL		-19.82	CASH		-20.00	CG		-0.18
	1 DEPT01	T2	-4.00																																		
	1 DEPT02	T1	-2.00																																		
1 DEPT03	T12	-6.00																																			
1 DEPT04		-7.00																																			
TA1		-8.00																																			
TX1		-0.32																																			
TA2		-10.00																																			
TX2		-0.50																																			
TL		-19.82																																			
CASH		-20.00																																			
CG		-0.18																																			
Quantity	1	T/S1																																			
Taxable	(2) _{preset}	2 00 2																																			
Item 2	Dept. 2	\$2.00	Pressing T/S1 changes the tax status from Nontaxable to Taxable 1																																		
	Quantity	1	T/S2																																		
	Taxable	(No)→1	6 00 3																																		
Item 3	Dept. 3	\$6.00	Pressing T/S2 changes the tax status from Taxable 1 to Taxable 1, 2																																		
	Quantity	1	T/S2																																		
	Taxable	(1)→1, 2	7 00 4																																		
Item 4	Dept. 4	\$7.00	Pressing T/S2 changes the tax status from Taxable 2 to Nontaxable																																		
	Quantity	1	SUB TOTAL																																		
	Taxable	(2)→No	2 0 00 CA/AMT/TEND																																		
Payment	Cash	\$20.00																																			

Important!

- To change the tax status of the next item to be registered, be sure to press T/S1, T/S2.
If the last item registered is programmed as nontaxable, a discount (%- key) operation on this item is always nontaxable.
In this case, you cannot manually change the tax status to Taxable 1 or 2 by pressing the T/S1, T/S2 keys.

Preparing and using discounts

This section describes how to prepare and register discounts.

Programming discounts

To program a rate to the **%-** key

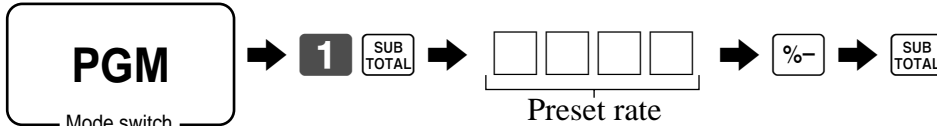

Example:

10% ⇨ **1 0**
 5.5% ⇨ **5 . 5**
 12.34% ⇨ **1 2 . 3 4**

Registering discounts



The following example shows how you can use the **%-** key in various types of registration.

Discount for items and subtotals

	Dept. 1	\$5.00
Item 1	Quantity	1
	Taxable	(1) _{preset}
	PLU 16	(\$10.00) _{preset}
Item 2	Quantity	1
	Taxable	(2) _{preset}
Discount	Rate	(5%) _{preset}
Subtotal discount	Rate	3.5%
	Taxable	Nontaxable
Payment	Cash	\$15.00

OPERATION

5 00 **1**
1 6 **PLU**
%-

Applies the preset discount rate to the last item registered.

3 . 5 **%-**

The input value takes priority of the preset value.

SUB TOTAL
1 5 00 **CA/AMT TEND**

RECEIPT

1 DEPT01	T1	-5.00
1 PLU0016	T2	· 10.00
5%		
%-	T2	-0.50
ST		· 14.50
3.5%		
%-		-0.51
TA1		· 5.00
TX1		· 0.20
TA2		· 9.50
TX2		· 0.48
TL		- 14.67
CASH		· 15.00
CG		· 0.33

- You can manually input rates up to 4 digits long (0.01% to 99.99%).

Taxable status of the **%-** key

- Whenever you perform a discount operation on the last item registered, the tax calculation for discount amount is performed in accordance with the tax status programmed for that item.
- Whenever you perform a discount operation on a subtotal amount, the tax calculation for the subtotal amount is performed in accordance with the tax status programmed for the **%-** key.

Preparing and using reductions

This section describes how to prepare and register reductions.

Programming for reductions

You can use the **[-]** key to reduce single item or subtotal amounts.

To program preset reduction amount

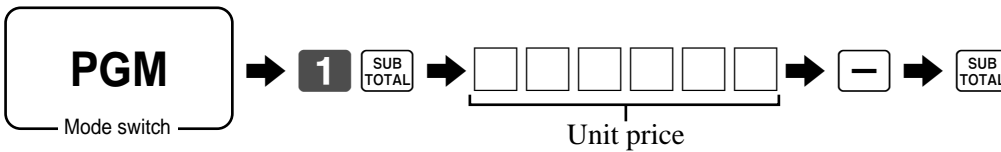

Registering reductions



The following examples show how you can use the **[-]** key in various types of registration.

Reduction for items

OPERATION			RECEIPT																											
Item 1	Dept. 1	\$5.00	<div style="display: flex; justify-content: space-between;"> <div style="width: 45%;"> <p style="text-align: center;"> 5 00 1 2 5 [-] Reduces the last amount registered by the value input. 4 5 PLU [-] SUB TOTAL 1 1 00 CA/AMT/TEND </p> </div> <div style="width: 50%; border: 1px solid black; padding: 5px;"> <table style="width: 100%; border-collapse: collapse;"> <tr><td>1 DEPT01</td><td>T1</td><td style="text-align: right;">-5.00</td></tr> <tr><td>-</td><td>T1</td><td style="text-align: right;">-0.25</td></tr> <tr><td>1 PLU0045</td><td>T1</td><td style="text-align: right;">-6.00</td></tr> <tr><td>-</td><td>T1</td><td style="text-align: right;">-0.50</td></tr> <tr><td>TA1</td><td></td><td style="text-align: right;">-10.25</td></tr> <tr><td>TX1</td><td></td><td style="text-align: right;">-0.41</td></tr> <tr><td>TL</td><td></td><td style="text-align: right;">-10.66</td></tr> <tr><td>CASH</td><td></td><td style="text-align: right;">-11.00</td></tr> <tr><td>CG</td><td></td><td style="text-align: right;">-0.34</td></tr> </table> </div> </div>	1 DEPT01	T1	-5.00	-	T1	-0.25	1 PLU0045	T1	-6.00	-	T1	-0.50	TA1		-10.25	TX1		-0.41	TL		-10.66	CASH		-11.00	CG		-0.34
1 DEPT01	T1	-5.00																												
-	T1	-0.25																												
1 PLU0045	T1	-6.00																												
-	T1	-0.50																												
TA1		-10.25																												
TX1		-0.41																												
TL		-10.66																												
CASH		-11.00																												
CG		-0.34																												
	Quantity	1																												
	Taxable	(1) _{preset}																												
Reduction	Amount	\$0.25																												
Item 2	PLU 45	(\$6.00) _{preset}																												
	Quantity	1																												
	Taxable	(1) _{preset}																												
Reduction	Amount	(\$0.50) _{preset}																												
Payment	Cash	\$11.00																												

- You can manually input reduction values up to 7 digits long.
- If you want to subtract the reduction amount from the department or PLU totalizer, program “Net totaling.”

Basic Operations and Setups

Reduction for subtotal

OPERATION

RECEIPT

Item 1	Dept. 1	\$3.00
	Quantity	1
	Taxable	(1) _{preset}
Item 2	Dept. 2	\$4.00
	Quantity	1
	Taxable	(2) _{preset}
Subtotal Reduction	Amount	\$0.75
	Taxable	(No) _{preset}
Payment	Cash	\$7.00

3 00 **1**

4 00 **2**

SUB
TOTAL

7 5 **-**

Reduces the subtotal by the value input here.

SUB
TOTAL

7 00 CA/AMT
/TEND

1	DEPT01	T1	·3.00
1	DEPT02	T2	·4.00
-			-0.75
	TA1		·3.00
	TX1		·0.12
	TA2		·4.00
	TX2		·0.20
	TL		-6.57
	CASH		·7.00
	CG		·0.43

Registering credit and check payments

The following examples show how to register credits and payments by check.

REG

Mode switch

Check

OPERATION

RECEIPT

Item	Dept. 1	\$11.00
	Quantity	1
Payment	Check	\$20.00

1 1 00 1
SUB TOTAL
2 0 00 CHK/TEND

1 DEPT01	.11.00
TL	- 11.00
CHECK	.20.00
CG	.9.00

Credit

OPERATION

RECEIPT

Item	Dept. 4	\$15.00
	Quantity	1
Reference	Number	1234
Payment	Credit	\$15.00

1 5 00 4
SUB TOTAL
1 2 3 4 #/NS
CR1

1 DEPT04	.15.00	
#/NS	1234	Reference No.
TL	- 15.00	
CREDIT1	.15.00	

Mixed tender (cash, credit and check)

OPERATION

RECEIPT

Item	Dept. 4	\$55.00
	Quantity	1
Payment	Check	\$30.00
	Cash	\$5.00
	Credit	\$20.00

5 5 00 4
SUB TOTAL
3 0 00 CHK/TEND
5 00 CA/AMT TEND
CR1

1 DEPT04	.55.00
TL	- 55.00
CHECK	.30.00
CASH	.5.00
CREDIT1	.20.00

Registering both the Euro and local currency



The following example shows the basic operation using the currency exchange function between the Euro and the local currency.

Case A

Main currency	Local
Payment	Euro
Change	Local
Rate	1 Euro = 0.5 FFr

OPERATION

DISPLAY

6 0 0 **1**

PD

← Press the **PD** key, which converts the subtotal amount into the sub currency by applying the preset exchange rate.

0.00E

**SUB
TOTAL**

After you press the **SUB
TOTAL** key, the result is shown on the display.

12.00E

PD

← Press the **PD** key if you enter the payment in the sub currency.

0.00E

1 5 00

15.00E

**CA/AMT
/TEND**

← Press the **CA/AMT
/TEND** key to finalize the transaction.
The change amount is shown in the programmed currency.

1.50

RECEIPT

1 DEPT01		·6.00
TL	-6.00	
		(12.00)
EURO money		
CASH		15.00
CG	-1.50	
		(3.00)

Case B

Main currency	Euro
Payment	Local
Change	Euro
Rate	1 Euro = 0.5 FFr

OPERATION

DISPLAY

1 2 00 **1**

PD

← Press the **PD** key, which converts the subtotal amount into the sub currency by applying the preset exchange rate.

SUB TOTAL

After you press the **SUB TOTAL** key, the result is shown on the display.

0.00L

6.00L

PD

← Press the **PD** key if you enter the payment in the sub currency.

6 00

0.00L

6.00L

CA/AMT/TEND

← Press the **CA/AMT/TEND** key to finalize the transaction. The change amount is shown in the programmed currency.

0.00

RECEIPT

1 DEPT01	12.00
TL	12.00
	(-6.00)
LOCAL money	
CASH	-6.00
CG	0.00
	(-0.00)

Registering returned goods in the REG mode



The following example shows how to use the **RF** key in the REG mode to register goods returned by customers.

OPERATION			RECEIPT																		
Item 1	Dept. 1	\$2.35	<table style="width: 100%; border-collapse: collapse;"> <tr><td>1 DEPT01</td><td style="text-align: right;">.2.35</td></tr> <tr><td>1 DEPT02</td><td style="text-align: right;">.2.00</td></tr> <tr><td>1 PLU0001</td><td style="text-align: right;">.1.20</td></tr> <tr><td>RF</td><td style="text-align: right;">.....</td></tr> <tr><td>1 DEPT01</td><td style="text-align: right;">-2.35</td></tr> <tr><td>RF</td><td style="text-align: right;">.....</td></tr> <tr><td>1 PLU0001</td><td style="text-align: right;">-1.20</td></tr> <tr><td>TL</td><td style="text-align: right;">- 2.00</td></tr> <tr><td>CASH</td><td style="text-align: right;">.2.00</td></tr> </table>	1 DEPT01	.2.35	1 DEPT02	.2.00	1 PLU0001	.1.20	RF	1 DEPT01	-2.35	RF	1 PLU0001	-1.20	TL	- 2.00	CASH	.2.00
	1 DEPT01	.2.35																			
1 DEPT02	.2.00																				
1 PLU0001	.1.20																				
RF																				
1 DEPT01	-2.35																				
RF																				
1 PLU0001	-1.20																				
TL	- 2.00																				
CASH	.2.00																				
Quantity	1																				
Item 2	Dept. 2	\$2.00																			
	Quantity	1																			
Item 3	PLU 1	(\$1.20) _{preset}																			
	Quantity	1																			
Returned Item 1	Dept. 1	\$2.35																			
	Quantity	1																			
Returned Item 3	PLU 1	(\$1.20) _{preset}																			
	Quantity	1																			
Payment	Cash	\$2.00																			

2 3 5 1
2 00 2
1 PLU
RF
2 3 5 1
 Press RF before the item you want to return.
RF
1 PLU
SUB TOTAL
CA/AMT TEND

Registering returned goods in the RF mode

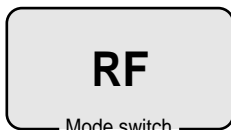

The following examples show how to use the RF mode to register goods returned by customers.

Normal refund transaction

OPERATION			RECEIPT												
Returned Item 1	Dept. 1	\$1.50	<table style="width: 100%; border-collapse: collapse;"> <tr><td>RF 03-06-2000(SAT) 11:50</td><td style="text-align: right;">RF mode symbol</td></tr> <tr><td>C01 MC#01 000023</td><td></td></tr> <tr><td>2 DEPT01</td><td style="text-align: right;">.3.00</td></tr> <tr><td>6 PLU0002</td><td style="text-align: right;">.7.20</td></tr> <tr><td>TL</td><td style="text-align: right;">- 10.20</td></tr> <tr><td>CASH</td><td style="text-align: right;">.10.20</td></tr> </table>	RF 03-06-2000(SAT) 11:50	RF mode symbol	C01 MC#01 000023		2 DEPT01	.3.00	6 PLU0002	.7.20	TL	- 10.20	CASH	.10.20
	RF 03-06-2000(SAT) 11:50	RF mode symbol													
C01 MC#01 000023															
2 DEPT01	.3.00														
6 PLU0002	.7.20														
TL	- 10.20														
CASH	.10.20														
Quantity	2														
Returned Item 2	PLU 2	(\$1.20) _{preset}													
	Quantity	6													
Payment	Cash	\$10.20													

1 5 0 1
1
6 X/DATE TIME
2 PLU
CA/AMT TEND

- The model for the U.S./Canada, use X/FOR DATE TIME instead of X/DATE TIME.

Reduction of amounts paid on refund

OPERATION			RECEIPT			
Returned Item 1	Dept. 3	\$4.00	4	00	3	1 DEPT03 T1 .4.00
	Quantity	1	1	5	-	- T1 -0.15
Reduction	Amount	\$0.15	2	PLU		1 PLU0002 T2 .1.20
Returned Item 2	PLU 2	(\$1.20) _{preset}		%-		5% T2 -0.06
	Quantity	1		SUB TOTAL		TA1 .3.85
Discount	Rate	(5%) _{preset}		CA/AMT TEND		TX1 .0.15
Payment	Cash	\$5.20				TA2 .1.14
						TX2 .0.06
						TL -5.20
						CASH .5.20

Important!

- To avoid miss registrations in the RF mode, return the mode switch to the former position immediately.

Registering money received on account



The following example shows how to register money received on account. This registration must be performed out of a sale.

OPERATION		RECEIPT	
Received amount	\$700.00	7	00 00 RC
			RC .700.00

Amount can be up to 8 digits.

Registering money paid out



The following example shows how to register money paid out from the register. This registration must be performed out of a sale.

OPERATION		RECEIPT	
Paid out amount	\$1.50	1	5 0 PD
			PD .1.50

Amount can be up to 8 digits.

Registering loan amounts

REG

Mode switch

Use this procedure to register loan or bank received from the office.

OPERATION

RECEIPT

Item	Note	\$1.00
	Quantity	10
	Note	\$5.00
	Quantity	5
Media	Cash	\$35.00

DATE TIME
1 0 DATE TIME
1 00 LOAN
5 DATE TIME
5 00 LOAN
 CA/AMT/TEND

LOAN	·10.00
LOAN	·25.00
CASH	·35.00

- The model for the U.S./Canada, use FOR DATE TIME instead of DATE TIME.

Registering pick up amounts

REG

Mode switch

Use this procedure to register pick up money from cash drawer.

OPERATION

RECEIPT

Item	Coin	\$0.50
	Quantity	10
	Coin	\$0.10
	Quantity	5
Media	Cash	\$5.50

DATE TIME
1 0 DATE TIME
5 0 PICK UP
5 DATE TIME
1 0 PICK UP
 CA/AMT/TEND

P. UP	·5.00
P. UP	·0.50
CASH	·5.50

- The model for the U.S./Canada, use FOR DATE TIME instead of DATE TIME.

Changing media in drawer

REG

Mode switch

Use this procedure to change media in drawer.

OPERATION

RECEIPT

Media	Check	-10.00
	Cash	\$8.00
	Charge	\$2.00

MEDIA CHANGE
1 0 00 CHK/TEND
 Enter the amount to be changed.
8 00 CA/AMT/TEND
2 00 CH

MEDIA CHG	·
CHECK	·10.00
CASH	·8.00
CH	·2.00

Making corrections in a registration

REG

Mode switch

There are three techniques you can use to make corrections in a registration.

- To correct an item that you input but not yet registered.
- To correct the last item you input and registered.
- To cancel all items in a transaction.

To correct an item you input but not yet registered

OPERATION

RECEIPT

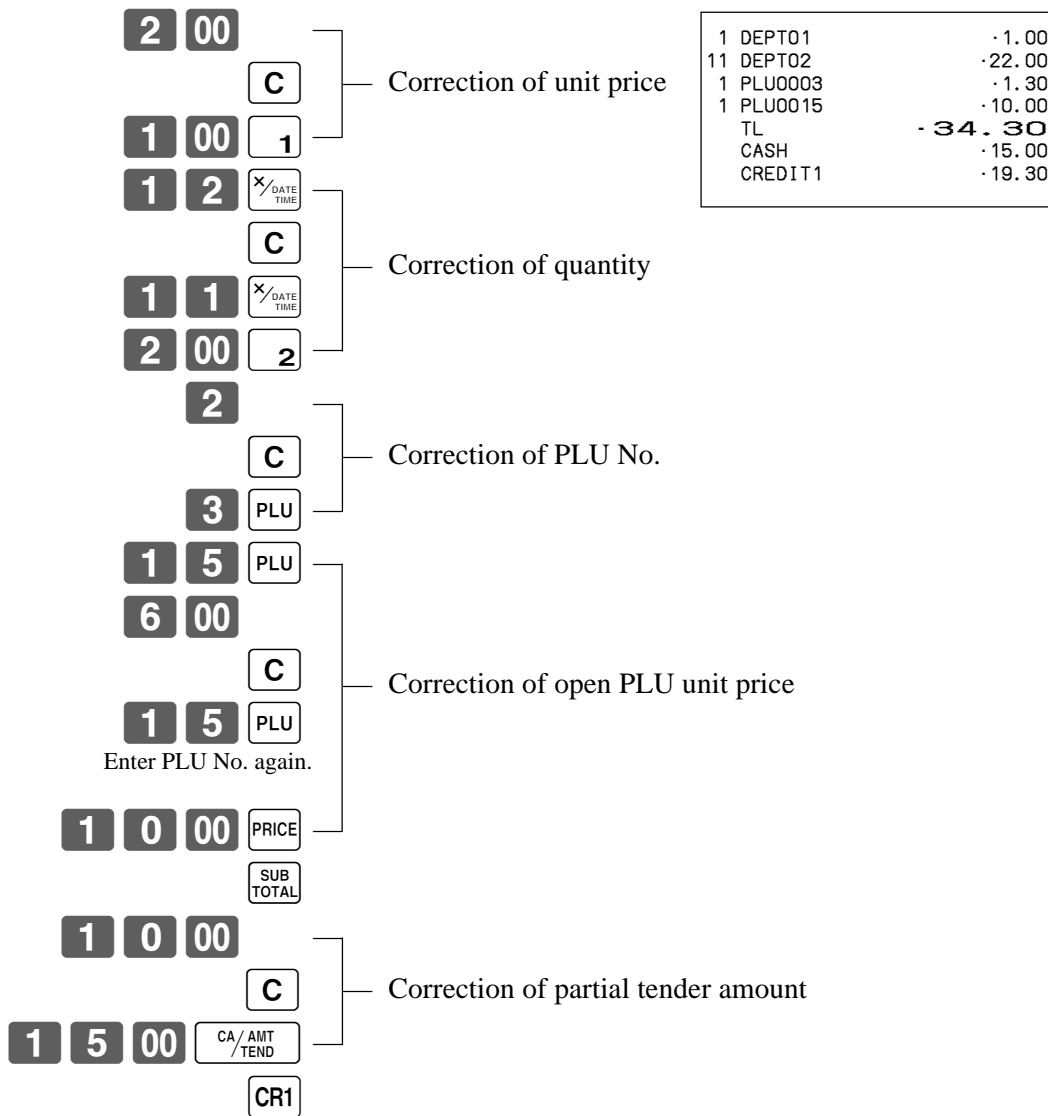

- The model for the U.S./Canada, use  instead of .

Basic Operations and Setups

To correct an item you input and registered

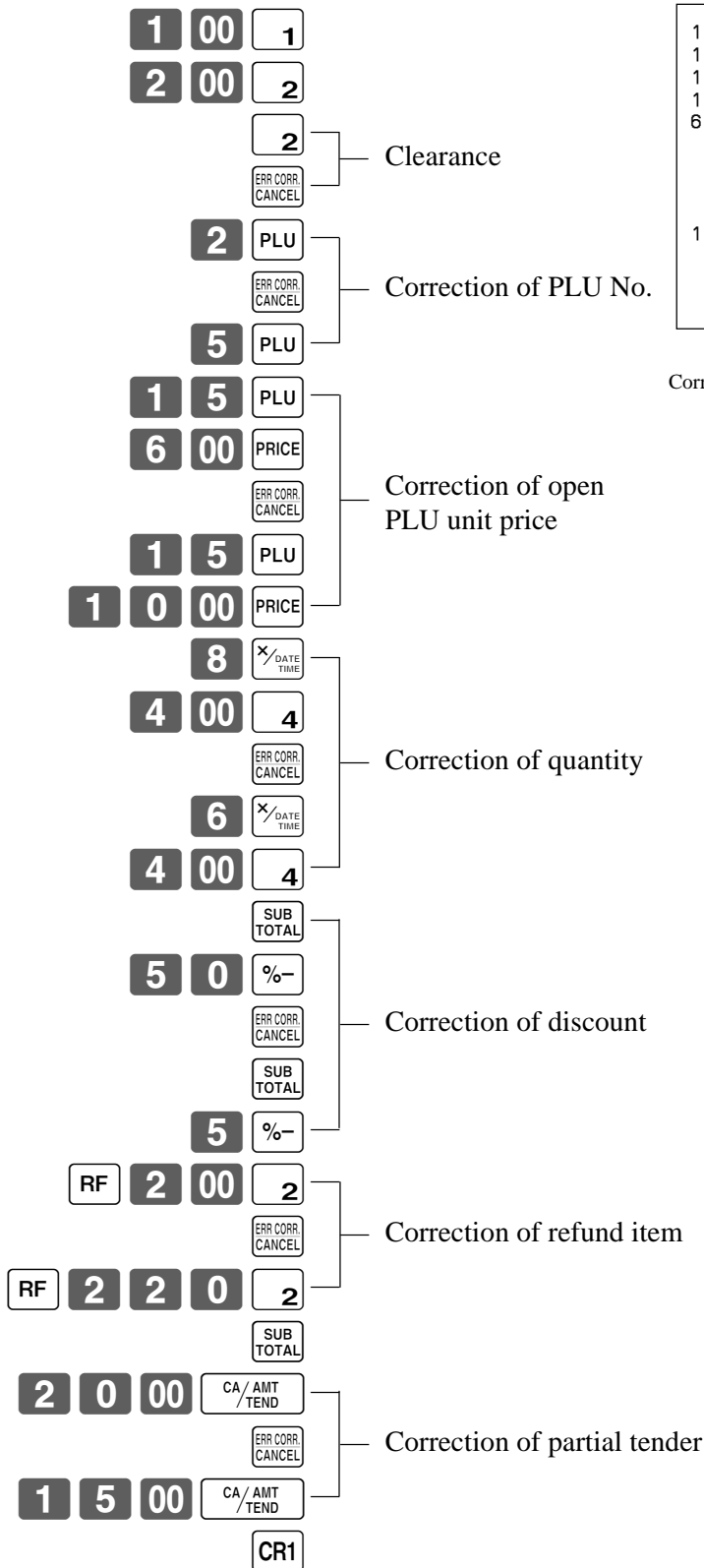

OPERATION

RECEIPT



1	DEPT01	· 1.00
1	DEPT02	· 2.00
1	PLU0005	· 1.50
1	PLU0015	· 10.00
6	DEPT04	· 24.00
	ST	· 38.50
	5%	
	%-	-1.93
	RF
1	DEPT02	-2.20
	TL	- 34.37
	CASH	· 15.00
	CREDIT1	· 19.37

Corrected items are not printed on receipt.

• The model for the U.S./Canada, use  instead of .

To cancel all items in a transaction

OPERATION	RECEIPT										
<div style="display: flex; flex-direction: column; align-items: center;"> <div style="display: flex; gap: 5px;"> <div style="border: 1px solid black; padding: 2px 5px;">1</div> <div style="border: 1px solid black; padding: 2px 5px;">00</div> <div style="border: 1px solid black; padding: 2px 5px;">1</div> </div> <div style="display: flex; gap: 5px;"> <div style="border: 1px solid black; padding: 2px 5px;">2</div> <div style="border: 1px solid black; padding: 2px 5px;">00</div> <div style="border: 1px solid black; padding: 2px 5px;">2</div> </div> <div style="display: flex; gap: 5px;"> <div style="border: 1px solid black; padding: 2px 5px;">3</div> <div style="border: 1px solid black; padding: 2px 5px;">00</div> <div style="border: 1px solid black; padding: 2px 5px;">3</div> </div> <div style="display: flex; gap: 5px;"> <div style="border: 1px solid black; padding: 2px 5px;">4</div> <div style="border: 1px solid black; padding: 2px 5px;">00</div> <div style="border: 1px solid black; padding: 2px 5px;">4</div> </div> <div style="border: 1px solid black; padding: 2px 5px; margin-top: 5px;">SUB TOTAL</div> </div>	<div style="border: 1px solid black; padding: 5px;"> <table style="width: 100%; border-collapse: collapse;"> <tr><td style="width: 80%;">1 DEPT01</td><td style="text-align: right;">-1.00</td></tr> <tr><td>1 DEPT02</td><td style="text-align: right;">-2.00</td></tr> <tr><td>1 DEPT03</td><td style="text-align: right;">-3.00</td></tr> <tr><td>1 DEPT04</td><td style="text-align: right;">-4.00</td></tr> <tr><td>CANCEL</td><td style="text-align: right;">.....</td></tr> </table> </div>	1 DEPT01	-1.00	1 DEPT02	-2.00	1 DEPT03	-3.00	1 DEPT04	-4.00	CANCEL
1 DEPT01	-1.00										
1 DEPT02	-2.00										
1 DEPT03	-3.00										
1 DEPT04	-4.00										
CANCEL										
<p>Pressing SUB TOTAL key is necessary to cancel the transaction.</p>											
	<div style="border: 1px solid black; padding: 2px 5px; display: inline-block;">ERR CORR. CANCEL</div>										

No sale registration



You can use the following procedure to open the drawer without registering a sale. This operation must be performed out of a sale.

OPERATION	RECEIPT		
<div style="border: 1px solid black; padding: 2px 5px; display: inline-block;"># NS</div>	<table style="width: 100%; border-collapse: collapse;"> <tr> <td style="width: 80%;">#/NS</td> <td style="text-align: right;">.....</td> </tr> </table>	#/NS
#/NS		

Printing the daily sales reset report

This report shows daily sales totals.

OPERATION

REPORT

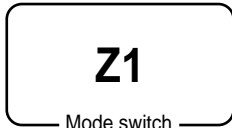

Mode switch



Z	03-06-2000(SAT)	17:00		Date/time
C01	MC#01	000231		Clerk name/mc No./consecutive No.

Z	BATCH	01		Report title

Z	FIX	0001		Fixed total report title/reset counter
		0001011		Report code

GROSS		981.25		Gross total *2
		.6,574.40		
NET	No	111		Net total *2
		.7,057.14		
CAID		.1,919.04		Cash in drawer *2
CHID		.139.04		Charge in drawer *2
CKID		.859.85		Check in drawer *2
CRID(1)		.709.85		Credit in drawer *2

RF	No	3		Refund mode *2
		.10.22		
CUST	CT	111		Number of customer *2
AVRG		.63.57		Average sales per customer *2
DC		.1.22		Discount total *2
REF		.2.42		Refund key *2
CLEAR	No	85		Clear key count *2
ROUND		.0.00		Rounding total *2
CANCEL	No	2		Cancellation *2
		.12.97		

TA1		.2,369.69		Taxable 1 amount *2
TX1		.128.86		Tax 1 amount *2
TA2		.2,172.96		Taxable 2 amount *2
TX2		.217.33		Tax 2 amount *2

GT1		.00000000125478.96		Grand total 1 *2
GT2		.00000000346284.23		Grand total 2 *2
GT3		.00000000123212.75		Grand total 3 *2

Z	TRANS	0001		Function key report title/reset counter
		0001012		Report code
CASH	No	362		Function key count/amount *1
		.1,638.04		
CHARGE	No	56		
		.1,174.85		

RC	No	4	
			·810.00
PD	No	5	
			·520.00

CORR	No	14	
			·39.55
VLD	No	19	
RCT	No	3	
NS	No	5	

Z	DEPT	0001	Department report title/reset counter
		0001015	Report code
DEPT01		203.25	Department count/amount *1
		·1,108.54	
DEPT02		183	
		·1,362.26	
		5	
			·108
			·7.22

TL		421.25	Department total count/total amount
		·2,872.28	

Z	CASHIER	0001	Clerk report title/reset counter
		0001017	Report code
C01	1	Clerk name/drawer No. *1
GROSS		421.25	Gross total *1
		·2,872.28	
NET	No	111	Net total *1
		·1,845.35	
CAID		·1,057.14	Cash in drawer *1
CHID		·139.04	
RF	No	1	Refund mode *1
		·1.00	
CLEAR	No	5	Clear key count *1
		·4.43	
C02	1	Clerk name/drawer No.

*1 Zero totalled departments/functions/clerks are not printed by programming.

*2 These items can be skipped by programming.

This chapter describes more sophisticated operations that you can use to suit the needs of your retail environment.

Stock check

Each PLU has an actual stock totalizer that you can program with a minimum stock quantity. Then the register checks actual stock quantities against the programmed minimum stock quantities. Stock operations are performed only for PLUs (except scanning PLUs) programmed with minimum stock quantities.

Stock warnings

The cash register checks for negative values in actual stock quantities during the registration itself. After registration is complete, it checks actual stock quantities against minimum stock quantities. The following warning indicators are used to inform the operator of any problem.

- **Negative stock:**

This indicates that the actual stock quantity is negative. You can also program the cash register to treat this condition as an error. This warning does not appear when the actual stock quantity is zero.

- **Under minimum stock:**

This indicates that the actual stock quantity is less than or equal to the minimum stock quantity. The cash register can be programmed so that a buzzer sounds when the actual stock quantity is less than the minimum stock quantity.

Notes

- The stock check operation is also performed for PLUs programmed with minimum stock quantities that make up set menus.
- None of the warning indicators appear unless the cash register is specifically programmed for the stock check operation.
- Stock operations can be performed for registrations in the RF mode or those performed with <REFUND> (the refund key).
- An error correct, void, or cancel operation restores the original of items in stock value.

Clerk interrupt function

There are two types of clerk interrupt function, illustrated by PROCEDURE 1 and PROCEDURE 2 below.

- In PROCEDURE 1, each clerk possesses a unique clerk interrupt buffer, and so the clerk interrupt function gives each individual clerk the ability to perform an independent registration operation. In this case, each clerk is individually linked to a unique clerk interrupt buffer.

- In PROCEDURE 2, multiple clerks use the same clerk interrupt buffer, and so a single clerk interrupt operation (clerk change during registration) can be performed any registration is in progress. In this case, multiple clerks are linked to a single clerk interrupt buffer.

Note the following important points concerning the clerk interrupt function.

- The register must be programmed to allow use of the clerk interrupt function.
- To use the clerk interrupt function, a clerk interrupt buffer must first be allocated with the memory allocation operation. Next the manager control operation (X1 mode) should be used to perform clerk assignment for the clerk interrupt function. The clerk interrupt operation cannot be performed by clerks who are not linked to a clerk interrupt buffer.
- You cannot use the clerk interrupt function on a register set up to function as part of a check tracking system. In the REG1, REG2, and RF modes, clerks can be change while a transaction is in progress, making it possible for multiple clerks to simultaneously perform registrations using a single register. For example, if clerk 1 is interrupted while registering a transaction, clerk 2 can use the same machine to register a different transaction. Then clerk 1 can continue the original registration from the point where it was interrupted.

PROCEDURE 1

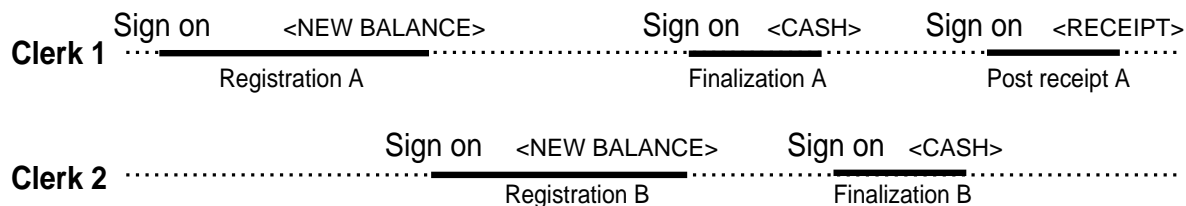

PROCEDURE 2

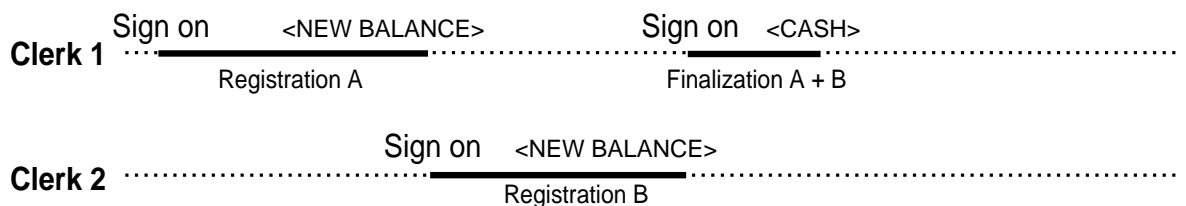

NOTES

- A guest receipt can be issued following clerk change, and receipts can be issued separately for each clerk.
- A cancel operation can be performed during registration by either of the clerks. When clerk 1 signs back on (after being interrupt by clerk 2), the cancel operation cancels only the items registered after signing back on (only this receipt) or from the top of the transaction. This is selectable by the key program.

Single item cash sales

A department key or PLU programmed with single item sale status finalizes the transaction as soon as it is registered.

The single item sales function cannot work properly if the keyboard does not include <CASH> (the cash key). The single item sales function can only be used for cash sales.

Example 1

	OPERATION	RECEIPT									
Item	<table border="1" style="width: 100%; border-collapse: collapse;"> <tr> <td style="width: 30%;">Dept. 1</td> <td style="width: 30%;">\$1.00</td> </tr> <tr> <td>Quantity</td> <td style="text-align: center;">1</td> </tr> <tr> <td>Status</td> <td style="text-align: center;">S.I.S</td> </tr> </table>	Dept. 1	\$1.00	Quantity	1	Status	S.I.S	<div style="display: flex; align-items: center; justify-content: center;"> <div style="margin-right: 10px;"> <div style="border: 1px solid black; padding: 2px; display: inline-block; text-align: center;">1</div> <div style="border: 1px solid black; padding: 2px; display: inline-block; text-align: center;">00</div> <div style="border: 1px solid black; padding: 2px; display: inline-block; text-align: center;">1</div> </div> <div style="margin-left: 10px;"> <p>The transaction is immediately finalized.</p> </div> </div>			
Dept. 1	\$1.00										
Quantity	1										
Status	S.I.S										
Payment	Cash \$1.00	<table border="1" style="width: 100%; border-collapse: collapse;"> <tr> <td style="width: 70%;">1 DEPT01</td> <td style="width: 10%; text-align: right;">. 1. 00</td> <td style="width: 20%;">Department No./</td> </tr> <tr> <td>TL</td> <td style="text-align: right;">- 1. 00</td> <td>unit price</td> </tr> <tr> <td>CASH</td> <td style="text-align: right;">. 1. 00</td> <td>Cash total amount</td> </tr> </table>	1 DEPT01	. 1. 00	Department No./	TL	- 1. 00	unit price	CASH	. 1. 00	Cash total amount
1 DEPT01	. 1. 00	Department No./									
TL	- 1. 00	unit price									
CASH	. 1. 00	Cash total amount									

Advanced Operations

Example 2

OPERATION

RECEIPT

Item	Dept. 1	(\$1.00)
	Quantity	3
	Status	S.I.S
Payment	Cash	\$3.00

3 DATE TIME
1

The transaction is immediately finalized.

3 DEPT01	-3.00
TL	- 3.00
CASH	-3.00

- The model for the U.S./Canada, use FOR DATE TIME instead of DATE TIME.

Example 3

OPERATION

RECEIPT

Item 1	Dept. 3	\$2.00
	Quantity	1
	Status	Normal
Item 2	Dept. 1	\$1.00
	Quantity	1
	Status	S.I.S
Payment	Cash	\$3.00

2 00 **3**
1

The transaction is not finalized. Because another item is registered before the single item sales department.

CA / AMT
TEND

1 DEPT03	-2.00
1 DEPT01	-1.00
TL	- 3.00
CASH	-3.00

Addition

Addition (plus)

Example

OPERATION

RECEIPT

Item 1	Dept. 1	\$1.00
	Quantity	1
	Addition	\$0.10
Item 2	Dept. 1	\$2.00
	Quantity	3
	Addition	3 × (\$0.20)
Payment	Cash	\$7.70

1 00 **1**
1 0 **+**
3 DATE TIME
2 00 **1**
3 DATE TIME
+
CA / AMT
TEND

1 DEPT01	-1.00
+	-0.10
3 DEPT01	-6.00
+	-0.60
TL	- 7.70
CASH	-7.70

- The model for the U.S./Canada, use FOR DATE TIME instead of DATE TIME.

Premium (%+)

Example

			OPERATION	RECEIPT																											
Item 1	Dept. 1	\$1.00	1 00 <input type="checkbox"/>	<table border="1"> <tr><td>1</td><td>DEPT01</td><td>·1.00</td></tr> <tr><td></td><td>10%</td><td></td></tr> <tr><td></td><td>%+</td><td>·0.10</td></tr> <tr><td>3</td><td>DEPT01</td><td>·6.00</td></tr> <tr><td></td><td>ST</td><td>·7.10</td></tr> <tr><td></td><td>15%</td><td></td></tr> <tr><td></td><td>%+</td><td>·1.07</td></tr> <tr><td></td><td>TL</td><td>- 8.17</td></tr> <tr><td></td><td>CASH</td><td>·8.17</td></tr> </table>	1	DEPT01	·1.00		10%			%+	·0.10	3	DEPT01	·6.00		ST	·7.10		15%			%+	·1.07		TL	- 8.17		CASH	·8.17
	1	DEPT01	·1.00																												
		10%																													
	%+	·0.10																													
3	DEPT01	·6.00																													
	ST	·7.10																													
	15%																														
	%+	·1.07																													
	TL	- 8.17																													
	CASH	·8.17																													
Quantity	1		1 0 <input type="checkbox"/>																												
Premium	10%		3 <input checked="" type="checkbox"/>																												
Item 2	Dept. 1	\$2.00	2 00 <input type="checkbox"/>																												
	Quantity	3	<input type="checkbox"/>																												
Subtotal	Premium	(15%)	<input type="checkbox"/>																												
Payment	Cash	\$8.17	<input type="checkbox"/>																												

- The model for the U.S./Canada, use FOR DATE TIME instead of DATE TIME.

Tray total

Tray total premium/discount

The buffer memory stores all items that fall into the prescribed range, starting from the first item registered for a transaction up to the point that <TRAY TOTAL> (the tray total key) is pressed to perform a tray total premium/discount operation. Following a premium/discount operation, the buffer is cleared and storage of new data starts from registration of the next item following the first premium/discount operation. The following operations clear the buffer memory.

- Press <TRAY TOTAL> twice.
- Press <TRAY TOTAL> and then perform a premium/discount operation. The contents of the buffer memory are restored if an error correction operation is performed to delete the premium/discount operation.

Example

OPERATION			RECEIPT		
Group 1	Dept. 1	\$1.00	1 00	1	1 DEPT01 .1.00
	Dept. 3	\$2.00	2 00	3	1 DEPT03 .2.00
	Discount	(5%) _{preset}		TRAY TOTAL	TRAY TL - 3.00
Group 2	Dept. 3	\$3.00		%-	5% -0.15
	Dept. 4	\$4.00	3 00	3	1 DEPT03 .3.00
	Discount	10%	4 00	4	1 DEPT04 .4.00
Payment	Cash	\$9.15		TRAY TOTAL	TRAY TL - 7.00
			1 0	%-	10% -0.70
				CA/AMT /TEND	TL - 9.15
					CASH -9.15

Multiple item totalling function

This function accumulates all items registered from the first item registered up to point that <TRAY TOTAL> is pressed, or all items between two presses of <TRAY TOTAL>. Pressing <TRAY TOTAL> displays the total amount with the tax included and prints it on the receipt and journal (printing on receipt and journal is programmable.)

Example

OPERATION			RECEIPT		
CustomerA	Dept. 1	\$1.00	1 00	1	1 DEPT01 .1.00
	Dept. 3	\$2.00	2 00	3	1 DEPT03 .2.00
CustomerB	Dept. 3	\$3.00		TRAY TOTAL	TRAY TL - 3.00
	Dept. 4	\$4.00	3 00	3	1 DEPT03 .3.00
Payment	Cash	\$10.00	4 00	4	1 DEPT04 .4.00
				TRAY TOTAL	TRAY TL - 7.00
				CA/AMT /TEND	TL - 10.00
					CASH -10.00

Coupon transactions

Note that errors result when the result of a calculation is negative if the cash register is programmed to prohibit credit balances.

Coupon registration using <COUPON> (coupon key)

Example

			OPERATION	RECEIPT
Item 1	Dept. 1	\$3.00	2 <input type="checkbox"/> DATE TIME	2 DEPT01 ·6.00 CPN -1.00 1 DEPT03 -4.00 CPN -1.00 TL - 8.00 CASH ·8.00
	Quantity	2	3 00 1	
	Coupon	\$0.50 × 2	2 <input type="checkbox"/> DATE TIME	
Item 2	Dept. 3	\$4.00	5 0 CPN	
	Quantity	1	4 00 3	
	Coupon	(\$1.00)	CPN	
Payment	Cash	\$8.00	CA/AMT TEND	

- The model for the U.S./Canada, use FOR DATE TIME instead of DATE TIME.

Coupon registration using <COUPON2> (coupon 2 key)

Example

			OPERATION	RECEIPT
Item 1	Dept. 1	\$15.00	1 5 00 1	1 DEPT01 ·15.00 CPN2 1 DEPT01 -1.50 1 PLU0010 -5.00 CPN2 1 PLU0050 -0.50 TL - 18.00 CASH ·18.00
	Quantity	1	CPN2 1 5 0 1	
	Coupon 2 Dept. 1	\$1.50	1 0 PLU	
Item 2	PLU 10	\$5.00	CPN2 5 0 PLU	
	Quantity	1		
	Coupon 2 PLU 50	(\$0.50)		
Payment	Cash	\$18.00	CA/AMT TEND	

Registering the second unit price

Second unit prices along with quantity modifiers can be programmed to PLUs. Pressing <PRICE SHIFT> (price shift key) calls up the second unit price, quantity modifier, and descriptor. Totalizers and inventory are adjusted by multiplying the number of items being registered by the quantity modifier programmed to the PLU being registered.

- <PRICE SHIFT> must be pressed before each registration of a PLU.
- Second unit price registration is no available with open PLUs when unit price is not preset.
- Second unit prices and quantity modifiers are assigned to PLUs using programming procedures described in the dealer's manual.
- Even if a PLU is programmed with a package quantity, the second unit price and quantity modifier are applied during registration following operation of <PRICE SHIFT>.

Example 1

OPERATION			RECEIPT									
Item 1	PLU 1 _{2nd@}	(\$10.00)	PRICE SHIFT 1 PLU	<table border="1"> <tr><td>1 PLU0001</td><td>.10.00</td></tr> <tr><td>1 PLU0010</td><td>.5.00</td></tr> <tr><td>TL</td><td>- 15.00</td></tr> <tr><td>CASH</td><td>.15.00</td></tr> </table>	1 PLU0001	.10.00	1 PLU0010	.5.00	TL	- 15.00	CASH	.15.00
	1 PLU0001	.10.00										
	1 PLU0010	.5.00										
TL	- 15.00											
CASH	.15.00											
Quantity	1	The operation declares that the next input is a second unit price.										
Unit Q'ty	1											
Item 2	PLU 10 _{2nd@}	(\$5.00)	PRICE SHIFT 1 0 PLU									
	Quantity	1	SUB TOTAL									
	Unit Q'ty	1	CA / AMT / TEND									
Payment	Cash	\$15.00										

Example 2

OPERATION			RECEIPT									
Item	PLU 2 _{2nd@}	(\$10.00)	5 <input checked="" type="checkbox"/> DATE TIME	<table border="1"> <tr><td>5 PLU0001</td><td>.50.00</td></tr> <tr><td>TL</td><td>- 50.00</td></tr> <tr><td>CASH</td><td>.50.00</td></tr> <tr><td>CG</td><td>.0.00</td></tr> </table>	5 PLU0001	.50.00	TL	- 50.00	CASH	.50.00	CG	.0.00
	5 PLU0001	.50.00										
	TL	- 50.00										
CASH	.50.00											
CG	.0.00											
Quantity	5	PRICE SHIFT 2 PLU										
2nd Q'ty	3	5 0 00 CA / AMT / TEND										
Payment	Cash	\$50.00										

- The model for the U.S./Canada, use **FOR DATE TIME** instead of **DATE TIME**.

Example 3

The procedure shown above are for when the cash register is programmed not to maintain a second unit price shift. It is programmed is performed to maintain a second unit price shift, the following procedure applies.

	OPERATION	RECEIPT	
Item 1	PLU 1 _{2nd@} (\$10.00)	<div style="text-align: center;"> PRICE SHIFT 1 PLU This operation shifts to registration of second unit price. 2 PLU PRICE SHIFT PRICE SHIFT 1 PLU This operation shifts back to registration of normal (first) unit price. 1 6 00 CA/AMT/TEND </div>	1 PLU0001 .10.00
	Quantity 1		1 PLU0002 .5.00
	Unit Q'ty 1		1 PLU0001 .1.00
Item 2	PLU 2 _{2nd@} (\$5.00)		TL -16.00
	Quantity 1		CASH .16.00
	Unit Q'ty 1		CG .0.00
Item 3	PLU 1 (\$1.00)		
	Quantity 1		
	Unit Q'ty 1		
Payment	Cash \$16.00		

Preset tender amount

An amount up to six digits long can be programmed to <CASH> (cash/amount tendered key). Then, when <CASH> is pressed without inputting a value, the programmed value is automatically registered and the transaction is finalized. When an amount is programmed to <CASH>, attempting to manually input an amount results in an error.

Example 1

	OPERATION	RECEIPT	
Item	Dept. 1 \$8.00	<div style="text-align: center;"> 8 00 1 CA/AMT/TEND The preset amount is tendered. </div>	1 DEPT01 .8.00
	Quantity 1		TL -8.00
Payment	Cash (\$10.00)		CASH .10.00
			CG .2.00

Example 2

	OPERATION	RECEIPT	
Item	Dept. 1 \$15.00	<div style="text-align: center;"> 1 5 00 1 1 0 00 CA/AMT/TEND An error occurs by manual input C 5 00 CHK/TEND CA/AMT/TEND </div>	1 DEPT01 .15.00
	Quantity 1		TL -15.00
Payment	Cash (\$10.00)		CHECK .5.00
	Check \$5.00		CASH .10.00
			CG .0.00

Bottle link operation

You can link PLU to a PLU.

Example

OPERATION			RECEIPT			
Item 1	PLU 1	(\$8.00)	1	PLU	1 PLU0001	-8.00
	PLU 11 _{linked}	(\$0.80)	3	<input checked="" type="checkbox"/> DATE TIME	1 PLU0011	-0.80
	Quantity	1	2	PLU	3 PLU0002	-15.00
Item 2	PLU 2	(\$5.00)	3	0	3 PLU0012	-1.50
	PLU 12 _{linked}	(\$0.50)	00	CA/AMT TEND	TL	-25.30
	Quantity	3			CASH	-30.00
Payment	Cash	\$30.00			CG	-4.70

- The model for the U.S./Canada, use FOR DATE TIME instead of DATE TIME.

Bottle returns

Bottle return key

You can use the linked bottle return key to register a bottle return. A PLU whose programmed unit price represents the contents of the bottle, can be linked with PLU whose programmed unit price represents the deposit on the bottle. In the following example, the bottle return key has been programmed to operate as a linked bottle return key.

The bottle return key must be pressed before input of each new linked bottle return.

Example

OPERATION			RECEIPT				
Return Item 1	PLU 1	(\$8.00)	BR	1	PLU	BR
	PLU 11 _{linked}	(\$0.80)	3	<input checked="" type="checkbox"/> DATE TIME		1 PLU0011	-0.80
	Quantity	1	BR	2	PLU	BR
Return Item 2	PLU 2	(\$5.00)			CA/AMT TEND	3 PLU0012	-1.50
	PLU 12 _{linked}	(\$0.50)				TL	-2.30
	Quantity	3				CASH	-2.30
Payment	Cash	\$2.30					

- The model for the U.S./Canada, use FOR DATE TIME instead of DATE TIME.

Arrangement key registrations

Key operations can be assigned to an <ARRANGE> (arrangement key). Then, simply pressing <ARRANGE> performs all of the key functions assigned to it.

Key operations can also be assigned to an address code. Then, when you input the address code using <ARRANGE>, all of the key functions assigned to the address code are performed.

Example 1

OPERATION			RECEIPT	
Arrangement 1			ARR	1 PLU0001 .8.00
Item 1	PLU 1	(\$8.00)		1 PLU0002 .5.00
	Quantity	1		TL - 13.00
Item 2	PLU 2	(\$5.00)		CASH .13.00
	Quantity	1		
Payment	Cash	\$13.00		

Example 2

OPERATION			RECEIPT	
Arrangement 5			5 ARR	1 DEPT01 .1.00
Item 1	Dept 1	\$1.00		1 DEPT02 .2.00
	Quantity	1		TL - 3.00
Item 2	Dept 2	\$2.00		CASH .3.00
	Quantity	1		
Payment	Cash	\$3.00		

Set menu

When you register a set menu, its total amount is added to the PLU totalizer and counter. The price of each set menu item is also added to each respective PLU totalizer and counter.

Example

OPERATION			RECEIPT	
Set menu	PLU 35	\$5.00	3 5 PLU	1 PLU0035 .5.00
Item 1	PLU 1	--	CA/AMT TEND	PLU0001
	PLU 2	--		PLU0002
Item 2	PLU 3	--		PLU0003
	PLU 4	--		PLU0004
Payment	Cash	\$5.00		TL - 5.00
				CASH .5.00

Currency exchange function

When <CE> (currency exchange key) is pressed, a current subtotal including tax is converted directly into foreign currency and the result is displayed, and the subsequent finalization is handled using the foreign currency. The currency exchange function is released by finalizing a transaction, partial tender operation, receipt issuance, or by pressing <SUBTOTAL>.



Before using the currency exchange function, it is necessary to program the conversion rate.









Registering foreign currency

Full amount tender in foreign currency

* Pre-programmed exchange rate: ¥ 100 = \$0.9524

Important!

Tenders in a foreign currency can be registered using the  and  only. Other finalize keys cannot be used.

OPERATION	DISPLAY	RECEIPT														
<p>1 0 00  ← Enter the unit price and press the applicable department key.</p>	<p>10.00 (Displays in \$)</p>	<table border="1"> <tr> <td>1 DEPT01</td> <td>· 10.00</td> </tr> <tr> <td>2 DEPT02</td> <td>· 20.00</td> </tr> <tr> <td>TL</td> <td>- 30.00</td> </tr> <tr> <td>CE</td> <td></td> </tr> <tr> <td>CASH</td> <td>¥5,000</td> </tr> <tr> <td>CASH</td> <td>· 47.62</td> </tr> <tr> <td>CG</td> <td>· 17.62</td> </tr> </table>	1 DEPT01	· 10.00	2 DEPT02	· 20.00	TL	- 30.00	CE		CASH	¥5,000	CASH	· 47.62	CG	· 17.62
1 DEPT01	· 10.00															
2 DEPT02	· 20.00															
TL	- 30.00															
CE																
CASH	¥5,000															
CASH	· 47.62															
CG	· 17.62															
<p>2 0 00  ← Enter the next unit price and press the applicable department key.</p>	<p>20.00 (Displays in \$)</p>															
<p>  ← Press  and  without entering a numeric value. This operation converts the subtotal (including tax) dollar value into yen by applying a pre-programmed exchange rate. The result is shown on the display and printed on the receipt/journal by programming.</p>	<p>3.150 (Displays in ¥: 3,150)</p>															
<p>5 0 00  ← Enter the amount tendered in yen and press . This operation converts the entered yen amount into dollars by applying a pre-programmed exchange rate. The result is shown on the display.</p> <p>(5,000)</p>	<p>5.000</p>															
<p> ← Press to finalize the transaction. Note that you do not need to reenter the dollar amount. The register automatically calculates the change amount due in dollars and shows it on the display, receipts and journal.</p>	<p>17.62 (Displays in \$)</p>															

Partial tender in a foreign currency

* Pre-programmed exchange rate: ¥ 100 = \$0.9524

Important!

Partial tender in a foreign currency can be registered using **CA/AMT/TEND** and **CHK/TEND** only. Other finalization keys cannot be used, but the remaining tender can be finalized using any finalize key.

OPERATION

DISPLAY

RECEIPT

1 0 00 **1**

← Enter the unit price and press the applicable department key.

10.00
(Displays in \$)

2 0 00 **2**

← Enter the next unit price and press the applicable department key.

20.00
(Displays in \$)

CE **SUB/TOTAL**

← Press **CE** and **SUB/TOTAL** without entering a numeric value. This operation converts the subtotal (including tax) dollar value into yen by applying a pre-programmed exchange rate. The result is shown on the display and printed on the receipt/journal by programming.

3.150
(Displays in ¥: 3,150)

2 0 00 **CE**
(2,000)

← Enter the partial amount tendered in yen and press **CE**. This operation converts the entered yen amount into dollars by applying a pre-programmed exchange rate. The result is shown on the display.

2.000

CA/AMT/TEND

← Press **CA/AMT/TEND** to specify cash tender for the yen partial tender. Note that you do not need to reenter the dollar amount. The register automatically deducts the dollar equivalent of the yen amount tendered from the total amount due and shows the amount on the display.

10.95
(Displays in \$)

CHK/TEND

← Press to finalize the transaction.

10.95
(Displays in \$)

1	DEPT01	· 10.00
1	DEPT02	· 20.00
	TL	- 30.00
	CE	
	CASH	¥2,000
	CASH	· 19.05
	CHK	· 10.95

Food stamp function

Food stamp registration

No change due



OPERATION

Item 1	Dept. 1	\$1.00
	Taxable	1, F/S
Item 2	Dept. 2	\$2.00
	Taxable	2
Item 3	Dept. 3	\$3.00
	Taxable	No → F/S
Payment	Food stamp	\$2.00
	Cash	\$4.14



Shifting food stamp status, press **F/S** key.

FS/ST

Press **FS/ST**, at the top of the food stamp tender.



CA/AMT/TEND

RECEIPT

1 DEPT01	T1 F	\$1.00	
1 DEPT02	T2	\$2.00	
1 DEPT03	F	\$3.00	
TA1		\$1.00	
TX1		\$0.04	
TA2		\$2.00	
TX2		\$0.10	
TL		\$6.14	Subtotal
FSST		\$4.04	Food stamp subtotal
FSTD		\$2.00	Food stamp tendered
CASH		\$4.14	

Mixed food stamp/cash change

Example 1

OPERATION			RECEIPT		
Item 1	Dept. 1	\$1.00	1 00	1	1 DEPT01 T1 F \$1.00
	Taxable	1, F/S	F/S 2 00	2	1 DEPT02 T2 F \$2.00
Item 2	Dept. 2	\$2.00	F/S 3 00	3	1 DEPT03 F \$3.00
	Taxable	2, F/S			TA1 \$1.00
Item 3	Dept. 3	\$3.00			TX1 \$0.04
	Taxable	F/S			TA2 \$2.00
Payment	Food stamp	\$7.00			TX2 \$0.10
					TL \$6.14 Subtotal
					FSST \$6.14 Food stamp subtotal
					FSTD \$7.00 Food stamp tendered
					CG \$0.86 Cash change

The change in food stamp transactions is automatically calculated as cash for amounts of \$1.00 or less, and as food stamps for amounts greater than \$1.00.

Example 2

OPERATION			RECEIPT		
Item	Dept. 1	\$2.00	2 00	1	1 DEPT01 T1 F \$2.00
	Taxable	1, F/S			TA1 \$2.00
Payment	Food stamp	\$5.00			TX1 \$0.08
					TL \$2.08
					FSST \$2.08
					FSTD \$5.00
					FSCG \$2.00
					CG \$0.92

In the above example, the total amount of change due is \$2.92; \$2.00 in food stamps and \$0.92 in cash.

Advanced Operations

Mixed food stamp/cash change (continued...)

Example 3

OPERATION			RECEIPT		
Item 1	Dept. 1	\$2.00	2 00	1	1 DEPT01 T1 F \$1.00 1 DEPT04 \$0.50 TA1 \$2.00 TX1 \$0.08 TL \$2.58 FSST \$2.08 FSTD \$5.00 FSCG \$2.00 CG \$0.42
	Taxable	1, F/S	5 0	4	
Item 2	Dept. 4	\$0.50		FS/ST	
	Taxable	No	5 00	FS/TD	
Payment	Food stamp	\$5.00			

When food stamp items are included in a transaction, the amount of change due in cash is applied as a cash amount tendered for cash (nonfood stamp) items. In this example, the \$0.50 purchased (department 4) is automatically deducted from the \$0.92 cash due in change from the food stamp purchase (department 4).

Example 4

OPERATION			RECEIPT		
Item 1	Dept. 1	\$1.00	1 00	1	1 DEPT01 T1 F \$1.00 1 DEPT02 T2 \$2.00 1 DEPT03 \$3.00 TA1 \$1.00 TX1 \$0.04 TA2 \$2.00 TX2 \$0.10 TL \$6.14 FSST \$1.04 FSTD \$5.00 FSCG \$3.00 CASH \$4.14
	Taxable	1, F/S	2 00	2	
Item 2	Dept. 2	\$2.00	3 00	3	
	Taxable	2		FS/ST	
Item 3	Dept. 3	\$3.00	5 00	FS/TD	
	Taxable	No		CA/AMT/TEND	
Payment	Food stamp	\$5.00			
	Cash	\$4.14			

The following calculation is performed internally to apply the cash change due on the food stamp transaction to the balance due of the cash transaction.

	Food stamp transaction	Cash transaction
Price items:	\$1.00	\$5.00
Tax:	\$0.04	\$0.10
Total due:	\$1.04	\$5.10
Amount tendered:	\$5.00 (food stamp)	\$4.14 (cash), \$0.96 (change from food stamp)
Amount due:	\$1.04	
Change amount due:	\$3.00 (food stamp), \$0.96 (cash)	
Total:		\$5.10

Food stamp registration (Illinois rule)

No change due

Example 1

			OPERATION	RECEIPT																		
Item 1	Dept. 1	\$1.00	1 00 1	<table border="1"> <tr><td>1 DEPT01</td><td>T1 F</td><td>\$1.00</td></tr> <tr><td>1 DEPT01</td><td>T1 F</td><td>\$2.00</td></tr> <tr><td>1 DEPT04</td><td>F</td><td>\$3.00</td></tr> <tr><td>TL</td><td></td><td>\$6.00</td></tr> <tr><td>FSST</td><td></td><td>\$6.00</td></tr> <tr><td>FSTD</td><td></td><td>\$6.00</td></tr> </table>	1 DEPT01	T1 F	\$1.00	1 DEPT01	T1 F	\$2.00	1 DEPT04	F	\$3.00	TL		\$6.00	FSST		\$6.00	FSTD		\$6.00
	1 DEPT01	T1 F	\$1.00																			
1 DEPT01	T1 F	\$2.00																				
1 DEPT04	F	\$3.00																				
TL		\$6.00																				
FSST		\$6.00																				
FSTD		\$6.00																				
Taxable	1, F/S		2 00 1																			
Item 2	Dept. 1	\$2.00	3 00 4																			
	Taxable	1, F/S	FS/ST																			
Item 3	Dept. 4	\$3.00	6 00 FS/TD																			
	Taxable	F/S																				
Payment	Food stamp	\$6.00																				

Example 2

			OPERATION	RECEIPT																								
Item 1	Dept. 1	\$2.00	2 00 1	<table border="1"> <tr><td>1 DEPT01</td><td>T1 F</td><td>\$2.00</td></tr> <tr><td>1 DEPT01</td><td>T1 F</td><td>\$3.00</td></tr> <tr><td>1 DEPT04</td><td>T1 F</td><td>\$4.00</td></tr> <tr><td>FSST</td><td></td><td>\$9.00</td></tr> <tr><td>FSTD</td><td></td><td>\$5.00</td></tr> <tr><td>TA1</td><td></td><td>\$4.00</td></tr> <tr><td>TX1</td><td></td><td>\$0.16</td></tr> <tr><td>CASH</td><td></td><td>\$4.16</td></tr> </table>	1 DEPT01	T1 F	\$2.00	1 DEPT01	T1 F	\$3.00	1 DEPT04	T1 F	\$4.00	FSST		\$9.00	FSTD		\$5.00	TA1		\$4.00	TX1		\$0.16	CASH		\$4.16
	1 DEPT01	T1 F	\$2.00																									
1 DEPT01	T1 F	\$3.00																										
1 DEPT04	T1 F	\$4.00																										
FSST		\$9.00																										
FSTD		\$5.00																										
TA1		\$4.00																										
TX1		\$0.16																										
CASH		\$4.16																										
Taxable	1, F/S		3 00 1																									
Item 2	Dept. 1	\$3.00	4 00 4																									
	Taxable	1, F/S	FS/ST																									
Item 3	Dept. 4	\$4.00	5 00 FS/TD																									
	Taxable	1, F/S																										
Payment	Food stamp	\$5.00	CA/AMT /TEND																									
	Cash	\$4.16																										

Advanced Operations

No change due (continued...)

Example 3

			OPERATION	RECEIPT																																				
Item 1	Dept. 1	\$2.00	2 00 1	<table border="1"> <tr><td>1</td><td>DEPT01</td><td>T1 F</td><td>\$2.00</td></tr> <tr><td>1</td><td>DEPT02</td><td>T2 F</td><td>\$3.00</td></tr> <tr><td></td><td>FSST</td><td></td><td>\$5.00</td></tr> <tr><td></td><td>FSTD</td><td></td><td>\$1.00</td></tr> <tr><td></td><td>TA1</td><td></td><td>\$1.00</td></tr> <tr><td></td><td>TX1</td><td></td><td>\$0.04</td></tr> <tr><td></td><td>TA2</td><td></td><td>\$3.00</td></tr> <tr><td></td><td>TX2</td><td></td><td>\$0.15</td></tr> <tr><td></td><td>CASH</td><td></td><td>\$4.19</td></tr> </table>	1	DEPT01	T1 F	\$2.00	1	DEPT02	T2 F	\$3.00		FSST		\$5.00		FSTD		\$1.00		TA1		\$1.00		TX1		\$0.04		TA2		\$3.00		TX2		\$0.15		CASH		\$4.19
	1	DEPT01	T1 F		\$2.00																																			
1	DEPT02	T2 F	\$3.00																																					
	FSST		\$5.00																																					
	FSTD		\$1.00																																					
	TA1		\$1.00																																					
	TX1		\$0.04																																					
	TA2		\$3.00																																					
	TX2		\$0.15																																					
	CASH		\$4.19																																					
	Taxable	1, F/S	3 00 2																																					
Item 2	Dept. 2	\$3.00	FS/ST																																					
	Taxable	2, F/S	1 00 FS/TD																																					
Payment	Food stamp	\$1.00	CA/AMT/TEND																																					
	Cash	\$4.19																																						

If this case, the result of the taxable 1 amount is \$1.00 (2.00 - 1.00), the taxable 2 amount is \$3.00.

Example 4

			OPERATION	RECEIPT																												
Item 1	Dept. 1	\$1.00	1 00 1	<table border="1"> <tr><td>1</td><td>DEPT01</td><td>T1 F</td><td>\$1.00</td></tr> <tr><td>1</td><td>DEPT02</td><td>T2 F</td><td>\$5.00</td></tr> <tr><td></td><td>FSST</td><td></td><td>\$6.00</td></tr> <tr><td></td><td>FSTD</td><td></td><td>\$4.00</td></tr> <tr><td></td><td>TA2</td><td></td><td>\$2.00</td></tr> <tr><td></td><td>TX2</td><td></td><td>\$0.10</td></tr> <tr><td></td><td>CASH</td><td></td><td>\$2.10</td></tr> </table>	1	DEPT01	T1 F	\$1.00	1	DEPT02	T2 F	\$5.00		FSST		\$6.00		FSTD		\$4.00		TA2		\$2.00		TX2		\$0.10		CASH		\$2.10
	1	DEPT01	T1 F		\$1.00																											
1	DEPT02	T2 F	\$5.00																													
	FSST		\$6.00																													
	FSTD		\$4.00																													
	TA2		\$2.00																													
	TX2		\$0.10																													
	CASH		\$2.10																													
	Taxable	1, F/S	5 00 2																													
Item 2	Dept. 2	\$5.00	FS/ST																													
	Taxable	2, F/S	4 00 FS/TD																													
Payment	Food stamp	\$4.00	CA/AMT/TEND																													
	Cash	\$2.10																														

In this case, the result of the taxable 1 amount is \$0.00 (1.00 - 1.00), the taxable 2 amount is \$2.00 (5.00 - (3.00 - 1.00)).

Mixed food stamp/cash change

Example 1

			OPERATION	RECEIPT																								
Item 1	Dept. 1	\$1.50	1 5 0 1	<table border="1"> <tr><td>1 DEPT01</td><td>T1 F</td><td>\$1.50</td></tr> <tr><td>1 DEPT01</td><td>T1 F</td><td>\$2.00</td></tr> <tr><td>1 DEPT04</td><td>F</td><td>\$3.00</td></tr> <tr><td>TL</td><td></td><td>\$6.50</td></tr> <tr><td>FSST</td><td></td><td>\$6.50</td></tr> <tr><td>FSTD</td><td></td><td>\$10.00</td></tr> <tr><td>FSCG</td><td></td><td>\$3.00</td></tr> <tr><td>CG</td><td></td><td>\$0.50</td></tr> </table>	1 DEPT01	T1 F	\$1.50	1 DEPT01	T1 F	\$2.00	1 DEPT04	F	\$3.00	TL		\$6.50	FSST		\$6.50	FSTD		\$10.00	FSCG		\$3.00	CG		\$0.50
	1 DEPT01	T1 F	\$1.50																									
1 DEPT01	T1 F	\$2.00																										
1 DEPT04	F	\$3.00																										
TL		\$6.50																										
FSST		\$6.50																										
FSTD		\$10.00																										
FSCG		\$3.00																										
CG		\$0.50																										
Taxable	1, F/S		2 00 1																									
Item 2	Dept. 1	\$2.00	3 00 4																									
	Taxable	1, F/S	FS/ST																									
Item 3	Dept. 4	\$3.00	1 0 00 FS/TD																									
	Taxable	F/S																										
Payment	Food stamp	\$10.00																										

The change in food stamp transactions is automatically calculated as cash for amount of \$1.00 or less, and as food stamps for amounts greater than \$1.00. In the above example, the total amount of change due is \$3.50 (\$3.00 in food stamps and \$0.50 in cash).

Example 2

			OPERATION	RECEIPT															
Item	Dept. 1	\$2.00	2 00 1	<table border="1"> <tr><td>1 DEPT01</td><td>T1 F</td><td>\$2.00</td></tr> <tr><td>TL</td><td></td><td>\$2.00</td></tr> <tr><td>FSST</td><td></td><td>\$2.00</td></tr> <tr><td>FSTD</td><td></td><td>\$5.00</td></tr> <tr><td>FSCG</td><td></td><td>\$3.00</td></tr> </table>	1 DEPT01	T1 F	\$2.00	TL		\$2.00	FSST		\$2.00	FSTD		\$5.00	FSCG		\$3.00
	1 DEPT01	T1 F	\$2.00																
TL		\$2.00																	
FSST		\$2.00																	
FSTD		\$5.00																	
FSCG		\$3.00																	
Taxable	1, F/S		FS/ST																
Payment	Food stamp	\$5.00	5 00 FS/TD																

Advanced Operations

Mixed food stamp/cash change (continued...)

Example 3

			OPERATION	RECEIPT																														
Item 1	Dept. 1	\$2.00	2 00 1	<table border="1"> <tr><td>1 DEPT01</td><td>T1 F</td><td>\$2.00</td></tr> <tr><td>1 DEPT01</td><td>T1 F</td><td>\$1.20</td></tr> <tr><td>1 DEPT03</td><td>T1</td><td>\$0.30</td></tr> <tr><td>TA1</td><td></td><td>\$0.30</td></tr> <tr><td>TX1</td><td></td><td>\$0.01</td></tr> <tr><td>TL</td><td></td><td>\$3.51</td></tr> <tr><td>FSST</td><td></td><td>\$3.20</td></tr> <tr><td>FSTD</td><td></td><td>\$5.00</td></tr> <tr><td>FSCG</td><td></td><td>\$1.00</td></tr> <tr><td>C6</td><td></td><td>\$0.49</td></tr> </table>	1 DEPT01	T1 F	\$2.00	1 DEPT01	T1 F	\$1.20	1 DEPT03	T1	\$0.30	TA1		\$0.30	TX1		\$0.01	TL		\$3.51	FSST		\$3.20	FSTD		\$5.00	FSCG		\$1.00	C6		\$0.49
	1 DEPT01	T1 F	\$2.00																															
1 DEPT01	T1 F	\$1.20																																
1 DEPT03	T1	\$0.30																																
TA1		\$0.30																																
TX1		\$0.01																																
TL		\$3.51																																
FSST		\$3.20																																
FSTD		\$5.00																																
FSCG		\$1.00																																
C6		\$0.49																																
	Taxable	1, F/S	1 2 0 1																															
Item 2	Dept. 1	\$1.20	3 0 3																															
	Taxable	1, F/S	FS/ST																															
Item 3	Dept. 3	\$0.30	5 00 FS/TD																															
	Taxable	1																																
Payment	Food stamp	\$5.00																																

When food stamp items are included in a transaction, the amount of change due in cash is applied as a cash amount tendered for cash (nonfood stamp) items. In this example, the \$0.30 purchase is automatically deducted from the \$0.80 cash due in change from the food stamp purchase.

Example 4

			OPERATION	RECEIPT																					
Item 1	Dept. 1	\$1.00	1 00 1	<table border="1"> <tr><td>1 DEPT01</td><td>T1 F</td><td>\$1.00</td></tr> <tr><td>1 DEPT01</td><td>T1 F</td><td>\$2.50</td></tr> <tr><td>1 DEPT03</td><td></td><td>\$5.00</td></tr> <tr><td>FSST</td><td></td><td>\$3.50</td></tr> <tr><td>FSTD</td><td></td><td>\$5.00</td></tr> <tr><td>FSCG</td><td></td><td>\$1.00</td></tr> <tr><td>CASH</td><td></td><td>\$4.50</td></tr> </table>	1 DEPT01	T1 F	\$1.00	1 DEPT01	T1 F	\$2.50	1 DEPT03		\$5.00	FSST		\$3.50	FSTD		\$5.00	FSCG		\$1.00	CASH		\$4.50
	1 DEPT01	T1 F	\$1.00																						
1 DEPT01	T1 F	\$2.50																							
1 DEPT03		\$5.00																							
FSST		\$3.50																							
FSTD		\$5.00																							
FSCG		\$1.00																							
CASH		\$4.50																							
	Taxable	1, F/S	2 5 0 1																						
Item 2	Dept. 1	\$2.50	5 00 3																						
	Taxable	1, F/S	FS/ST																						
Item 3	Dept. 3	\$5.00	5 00 FS/TD																						
	Taxable	No																							
Payment	Food stamp	\$5.00	CA/AMT/TEND																						
	Cash	\$4.50																							

The following calculation is performed internally to apply the cash change due on the food stamp transaction to the balance due of the cash transaction.

	Food stamp transaction	Cash transaction
Price items:	\$3.50	\$5.00
Tax:	\$0.00	\$0.00
Total due:	\$3.50	\$5.00
Amount tendered:	\$5.00 (food stamp)	\$4.50 (cash), \$0.50 (change from food stamp)
Amount due:	\$3.50	
Change amount due:	\$1.00 (food stamp), \$0.50 (cash)	
Total:		\$5.00

Electronic benefits transfer

In addition to standard food stamp tender finalizations, this model also allows finalization for tenders electronic benefits transfer (EBT) card.

EBT tenders can be accepted for New Jersey rule or Illinois rule food stamp tenders, as well as for food stamp tenders that do not follow these rules.

About mixed EBT card tenders

When the register is programmed to prohibit an EBT amount tendered that exceeds the food stamp subtotal, nonfood stamp items cannot be paid for using an EBT card. In this case, the following applies:

- $ST - (EBT/TEND - FS/ST) = \text{Balance due}$ (the remaining balance due must be finalized using another finalize key.)

When the register is programmed to allow an EBT amount tendered that exceeds the food stamp subtotal, nonfood stamp items can be paid for using an EBT card. In this case, there are two possible situations:

- $ST > EBT/TEND$
 $ST - (EBT/TEND - FS/ST) = \text{Balance due}$ (the remaining balance due must be finalized using another finalize key.)
- $EBT/TEND > \text{or} = ST$
 $EBT/TEND - ST = \text{cash change}$

No change due

Example 1

OPERATION			RECEIPT																		
Item 1	Dept. 1	\$1.00	<table style="width: 100%; border-collapse: collapse;"> <tr><td>1 DEPT01</td><td>T1 F</td><td>\$1.00</td></tr> <tr><td>1 DEPT02</td><td>T2 F</td><td>\$2.00</td></tr> <tr><td>1 DEPT03</td><td>F</td><td>\$2.00</td></tr> <tr><td>TL</td><td></td><td>\$6.00</td></tr> <tr><td>FSST</td><td></td><td>\$6.00</td></tr> <tr><td>EBTTD</td><td></td><td>\$6.00</td></tr> </table>	1 DEPT01	T1 F	\$1.00	1 DEPT02	T2 F	\$2.00	1 DEPT03	F	\$2.00	TL		\$6.00	FSST		\$6.00	EBTTD		\$6.00
	1 DEPT01	T1 F		\$1.00																	
1 DEPT02	T2 F	\$2.00																			
1 DEPT03	F	\$2.00																			
TL		\$6.00																			
FSST		\$6.00																			
EBTTD		\$6.00																			
Taxable	1, F/S																				
Item 2	Dept. 2	\$2.00																			
	Taxable	2, F/S																			
Item 3	Dept. 3	\$3.00																			
	Taxable	F/S																			
Payment	EBT	\$6.00																			

1 00 1

2 00 2

3 00 3

FS/ST

6 00 EBT

Advanced Operations

Example 2

OPERATION			RECEIPT																											
Item 1	Dept. 1	\$1.00	1 00 1	<table border="1" style="width: 100%; border-collapse: collapse;"> <tr><td>1 DEPT01</td><td>T1 F</td><td>\$1.00</td></tr> <tr><td>1 DEPT02</td><td>T1 F</td><td>\$2.00</td></tr> <tr><td>1 DEPT03</td><td>T1</td><td>\$3.00</td></tr> <tr><td>FSST</td><td></td><td>\$3.00</td></tr> <tr><td>EBTTD</td><td></td><td>\$5.00</td></tr> <tr><td>TA1</td><td></td><td>\$3.00</td></tr> <tr><td>TX1</td><td></td><td>\$0.12</td></tr> <tr><td>CASH</td><td></td><td>\$1.12</td></tr> </table>	1 DEPT01	T1 F	\$1.00	1 DEPT02	T1 F	\$2.00	1 DEPT03	T1	\$3.00	FSST		\$3.00	EBTTD		\$5.00	TA1		\$3.00	TX1		\$0.12	CASH		\$1.12		
	1 DEPT01	T1 F	\$1.00																											
1 DEPT02	T1 F	\$2.00																												
1 DEPT03	T1	\$3.00																												
FSST		\$3.00																												
EBTTD		\$5.00																												
TA1		\$3.00																												
TX1		\$0.12																												
CASH		\$1.12																												
	Taxable	1, F/S	2 00 2																											
Item 2	Dept. 2	\$2.00	3 00 3																											
	Taxable	1, F/S	FS/ST																											
Item 3	Dept. 3	\$3.00	5 00 EBT																											
	Taxable	1	CA/AMT/TEND																											
Payment	EBT	\$5.00																												
	Cash	\$1.12																												

Change due

OPERATION			RECEIPT																														
Item 1	Dept. 1	\$1.00	1 00 1	<table border="1" style="width: 100%; border-collapse: collapse;"> <tr><td>1 DEPT01</td><td>T1 F</td><td>\$1.00</td></tr> <tr><td>1 DEPT02</td><td>T1 F</td><td>\$1.20</td></tr> <tr><td>1 DEPT03</td><td>T1</td><td>\$0.30</td></tr> <tr><td>TA1</td><td></td><td>\$0.30</td></tr> <tr><td>TX1</td><td></td><td>\$0.01</td></tr> <tr><td>TL</td><td></td><td>\$2.51</td></tr> <tr><td>FSST</td><td></td><td>\$2.20</td></tr> <tr><td>EBTTD</td><td></td><td>\$5.00</td></tr> <tr><td>CG</td><td></td><td>\$2.49</td></tr> </table>	1 DEPT01	T1 F	\$1.00	1 DEPT02	T1 F	\$1.20	1 DEPT03	T1	\$0.30	TA1		\$0.30	TX1		\$0.01	TL		\$2.51	FSST		\$2.20	EBTTD		\$5.00	CG		\$2.49		
	1 DEPT01	T1 F	\$1.00																														
1 DEPT02	T1 F	\$1.20																															
1 DEPT03	T1	\$0.30																															
TA1		\$0.30																															
TX1		\$0.01																															
TL		\$2.51																															
FSST		\$2.20																															
EBTTD		\$5.00																															
CG		\$2.49																															
	Taxable	1, F/S	1 2 0 2																														
Item 2	Dept. 2	\$1.20	3 0 3																														
	Taxable	1, F/S	FS/ST																														
Item 3	Dept. 3	\$0.30	5 00 EBT																														
	Taxable	1																															
Payment	EBT	\$5.00																															

Tips

Example

OPERATION			RECEIPT																					
Item 1	Unit price	\$3.00	3 00 1	<table border="1" style="width: 100%; border-collapse: collapse;"> <tr><td>1 DEPT01</td><td></td><td>-3.00</td></tr> <tr><td>1 DEPT02</td><td></td><td>-5.00</td></tr> <tr><td>TIP</td><td></td><td>-0.80</td></tr> <tr><td>TL</td><td></td><td>\$8.80</td></tr> <tr><td>CASH</td><td></td><td>\$10.00</td></tr> <tr><td>CG</td><td></td><td>\$1.20</td></tr> </table>	1 DEPT01		-3.00	1 DEPT02		-5.00	TIP		-0.80	TL		\$8.80	CASH		\$10.00	CG		\$1.20		
	1 DEPT01		-3.00																					
1 DEPT02		-5.00																						
TIP		-0.80																						
TL		\$8.80																						
CASH		\$10.00																						
CG		\$1.20																						
	Dept.	1	5 00 2																					
Item 2	Unit price	\$5.00	SUB TOTAL																					
	Dept.	2	8 0 TIP																					
Tip	Amount	\$0.80	1 0 00 CA/AMT/TEND																					
Payment	Cash	\$10.00																						

Inputting the number of customers

Example 1

OPERATION			RECEIPT									
Item 1	Unit price	\$15.00	1	5	00	1	CST	2	CST	CT	2	
	Dept.	1										
Item 2	Unit price	\$5.00	5	00	2	SUB TOTAL	CA/AMT/TEND	2	SUB TOTAL	1 DEPT01	15.00	
	Dept.	2										
Customer	Number	2							TL	- 20.00	CASH	20.00
Payment	Cash	\$20.00										

Example 2

You can only use the following operation to re-input the number of customers when <CUSTOMER> (customer number key) is preset to allow re-input. When programming prohibits re-input of the number of customers, this operation causes an error.

OPERATION			RECEIPT									
1	5	00	1	CST	3	CST	CT	3	CT	3		
											5	00
2	0	00	2	CST	2	SUB TOTAL	CA/AMT/TEND	2	1 DEPT02	5.00		
											2	CST
2		0	00	CA/AMT/TEND					TL	- 20.00	CASH	20.00

You can re-input the number of customers either immediately after the initial input or during later registration.

Example 3

You can use the following operation to add customers to an original number of customers input (when addition to the number of the customer is allowed).

OPERATION			RECEIPT									
1	5	00	1	CST	3	CST	CT	3	CT	3		
											5	00
2	0	00	2	CST	2	SUB TOTAL	CA/AMT/TEND	2	1 DEPT02	5.00		
											2	CST
2		0	00	CA/AMT/TEND					TL	- 20.00	CASH	20.00

Advanced Operations

Text recall

This procedure is used to recall text by inputting the address where the text is stored. The recalled text is printed on the receipt and journal.

Example

OPERATION			RECEIPT																
Item 1	Unit price	\$46.00	4 6 00	1	<table border="1"> <tr><td>CT</td><td>3</td></tr> <tr><td>1 DEPT01</td><td>-46.00</td></tr> <tr><td>MEDIUM SIZE</td><td></td></tr> <tr><td>1 DEPT02</td><td>-10.00</td></tr> <tr><td>SMALL SIZE</td><td></td></tr> <tr><td>TL</td><td>-56.00</td></tr> <tr><td>CASH</td><td>-56.00</td></tr> </table>	CT	3	1 DEPT01	-46.00	MEDIUM SIZE		1 DEPT02	-10.00	SMALL SIZE		TL	-56.00	CASH	-56.00
	CT	3																	
1 DEPT01	-46.00																		
MEDIUM SIZE																			
1 DEPT02	-10.00																		
SMALL SIZE																			
TL	-56.00																		
CASH	-56.00																		
Dept.	1	1	TEXT RECALL																
Item 2	Unit price	\$10.00	1 0 00	2															
	Dept.	2	2	TEXT RECALL															
Payment	Cash	\$56.00		SUB TOTAL															
Text 1	MEDIUM SIZE			CA/AMT /TEND															
Text 2	SMALL SIZE																		

Temporarily releasing compulsion

<OPEN 2> (open 2 key) can be programmed to release specific compulsion.

Example 1

OPERATION			RECEIPT								
Item	Unit price	\$10.00	1 0 00	1	<table border="1"> <tr><td>1 DEPT01</td><td>-10.00</td></tr> <tr><td>TL</td><td>-10.00</td></tr> <tr><td>CHECK</td><td>-10.00</td></tr> </table>	1 DEPT01	-10.00	TL	-10.00	CHECK	-10.00
	1 DEPT01	-10.00									
TL	-10.00										
CHECK	-10.00										
Dept.	1	1 0 00	CHK/ TEND								
Payment	Check	\$10.00									
Validation compulsory			2 00	2							
Validation compulsory				Validation compulsory is temporarily released.							
			OPEN 2								

Example 2

OPERATION			RECEIPT								
Input customer No. compulsory			1 0 00	1	<table border="1"> <tr><td>1 DEPT01</td><td>-10.00</td></tr> <tr><td>TL</td><td>-10.00</td></tr> <tr><td>CHECK</td><td>-10.00</td></tr> </table>	1 DEPT01	-10.00	TL	-10.00	CHECK	-10.00
1 DEPT01	-10.00										
TL	-10.00										
CHECK	-10.00										
Item	Unit price	\$10.00	Input customer No. compulsory								
	Dept.	1	OPEN 2								
Payment	Check	\$10.00	Compulsory is temporarily released.								
			1 0 00	1							
			1 0 00	CHK/ TEND							

Printing slip

To perform batch printing on the slip printer, you must first use the memory allocation operation (see program 5 mode in the dealer's manual) to reserve slip buffer memory. The capacity of the slip buffer memory is determined by the number of units of slip buffer memory reserved by the memory allocation operation.

The register can be programmed to check the status of the registration buffer memory whenever slip batch printing is performed, and sound an alarm when the buffer memory is almost full. The alarm sounds when there are 12 lines or less remaining, and once it starts to sound, the only operation you can perform is the cancel operation or operations using one of the following keys.

- <CA/AMT TEND> (cash/amount tendered key) operation
- <CH> (charge key) operation
- <CHK/TEND> (check tendered key) operation
- <DEPOSIT> (deposit key) operation
- <NEW BALANCE> (new balance key) operation
- <SUBTOTAL> (subtotal key) operation

You must perform one of above operations when the registration buffer alarm sounds. Any other operations results in an error.

Printing slips

The cash register can be connected to the optional SP-1300 slip printer, which features an automatic feed function and automatic back feed function.

• Automatic feed function

This function makes it possible to program the number of line feeds that should be inserted from the normal print start position before starting slip printing of a new slip. Even if line feeds are programmed for this function, they are not inserted for validation printing, check endorsement printing, and check printing performed using the slip printer. Note also that line feeds are not inserted automatically at the beginning of a second slip when the transaction requires printing that extends from one slip to another.

• Automatic back feed function

This function performs automatic back feed following slip printing, validation printing, and endorsement printing on the slip printer. The slip paper is released once the back feed operation is complete.

• Manual feed function

<SLIP FEED/RELEASE> (slip feed/release key: assigned to the register's keyboard using the program 4 mode) can be used for manual feed of the slip paper. You perform manual feed by inputting a value for the number of lines (up to two digits in the range of 1 to 99) and then press <SLIP FEED/RELEASE>.

• Manual back feed function

<SLIP BACK FEED/RELEASE> (slip back feed/release key: assigned to the register's keyboard using the program 4 mode) can be used for manual back feed of the slip paper. Manual back feed can be performed by inputting a value for the number of lines (up to two digits in the range of 1 to 99) and then press <SLIP BACK FEED/RELEASE>.

You can print slips using automatic or manual batch printing. The slip print operation can be performed in REG1, REG2, and RF modes only.

Finalizing a registration without inserting a slip paper into the slip printer when the register is programmed as "slip paper insertion into slip printer compulsory before finalizing registration" produces an error.

Advanced Operations

To perform auto batch printing 1

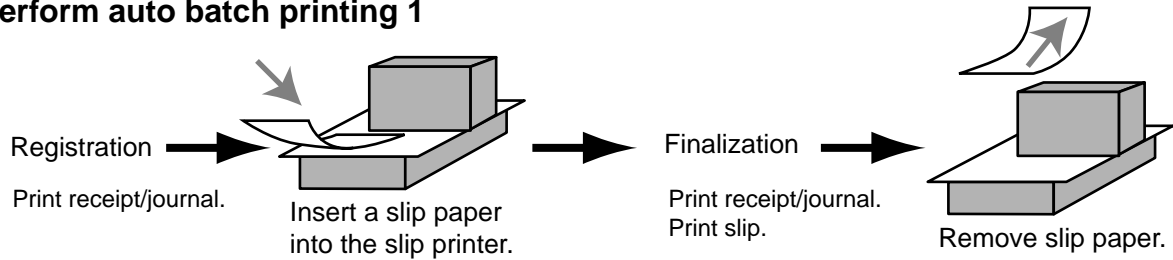

To perform auto batch printing 2

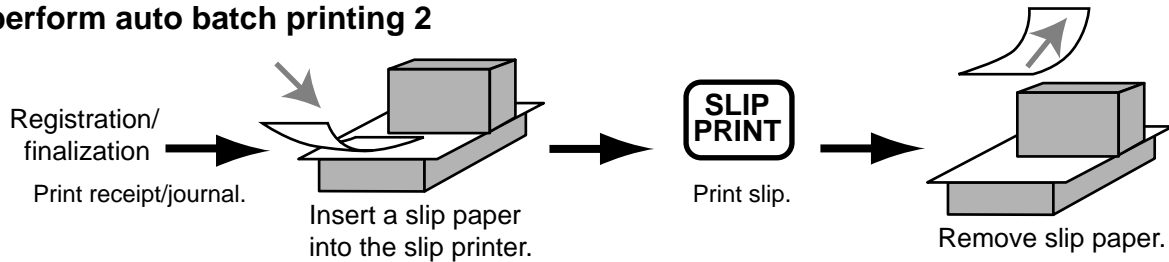

About the maximum number of slip lines

You can program the maximum number of lines that can be printed on a slip. Once you do, any attempt to exceed the preset maximum results in an error. When such an error occurs, press <C>, change slip paper and press <SLIP PRINT> to restart printing.

Check tracking systems

Check tracking system

With the check tracking system, the amount, check number, number of slip print lines, store number, date/time and registration detail data are stored in two files (check tracking index file and check tracking detail file).

- Check tracking detail file and index file are cleared by the following timing:
 1. The check is cleared after printing finalized data on slip or guest check receipts, or the check is also cleared when the new or old check operation is made.
 2. The check is cleared after printing finalized data on slip or guest check receipt, or check is also cleared when the same finalized check number is assigned in new check operation.You can select one of these options by programming.
- Auto new balance function
The register can be programmed so that whenever a clerk (by clerk key) signs off while a check is open, a <NEW BALANCE> operation is automatically performed to temporarily finalize the open check.
- You can specify a range of checks that can be opened by each clerk. Once you do, any attempt by a clerk to open a check using a number that is not within his specified range results in an error.
- Either of the following two operations can be used to correct input of a wrong check number.
 - <NEW CHECK>
Re-input the correct check number, or cancel the original check number, issue a receipt, and then re-input the correct check number.
 - <OLD CHECK>, <NEW/OLD>
Temporary finalize the original check number, issue a receipt, and then re-input the correct check number.

Opening a check

Example

OPERATION			RECEIPT																		
Check#	1234		<table border="1" style="width: 100%; border-collapse: collapse;"> <tr> <td colspan="2">CHECK No. 1234</td> </tr> <tr> <td>TBL#</td> <td>000033</td> </tr> <tr> <td>1 DEPT01</td> <td>.10.00</td> </tr> <tr> <td>1 DEPT01</td> <td>.10.00</td> </tr> <tr> <td>1 DEPT02</td> <td>.20.00</td> </tr> <tr> <td>1 DEPT02</td> <td>.20.00</td> </tr> <tr> <td>1 DEPT03</td> <td>.30.00</td> </tr> <tr> <td>+</td> <td>.0.50</td> </tr> <tr> <td>SRVC TL</td> <td>- 90.50</td> </tr> </table>	CHECK No. 1234		TBL#	000033	1 DEPT01	.10.00	1 DEPT01	.10.00	1 DEPT02	.20.00	1 DEPT02	.20.00	1 DEPT03	.30.00	+	.0.50	SRVC TL	- 90.50
CHECK No. 1234																					
TBL#	000033																				
1 DEPT01	.10.00																				
1 DEPT01	.10.00																				
1 DEPT02	.20.00																				
1 DEPT02	.20.00																				
1 DEPT03	.30.00																				
+	.0.50																				
SRVC TL	- 90.50																				
Table#	33																				
Item 1	Dept 1	\$10.00																			
	Quantity	2																			
Item 2	Dept 2	\$20.00																			
	Quantity	2																			
Item 3	Dept 3	\$30.00																			
	Quantity	1																			

1 2 3 4 NEW CHECK

3 3 TABLE #

1 0 00 1

2 0 00 2

3 0 00 3

Insert slip

NB

Remove slip

Press <NEW BALANCE> to temporarily close the transaction. If you want to finalize a check immediately, use <CASH>, <CHARGE>, <CREDIT> or <CHECK>.

Adding to a check

Example

OPERATION			RECEIPT														
Check#	1234		<table border="1" style="width: 100%; border-collapse: collapse;"> <tr> <td>TABLE No. 000033</td> <td>CT 1</td> </tr> <tr> <td colspan="2">CHECK No. 1234</td> </tr> <tr> <td>ST</td> <td>.90.50</td> </tr> <tr> <td>1 DEPT01</td> <td>.30.00</td> </tr> <tr> <td>1 DEPT02</td> <td>.10.00</td> </tr> <tr> <td>+</td> <td>.0.50</td> </tr> <tr> <td>SRVC TL</td> <td>- 131.00</td> </tr> </table>	TABLE No. 000033	CT 1	CHECK No. 1234		ST	.90.50	1 DEPT01	.30.00	1 DEPT02	.10.00	+	.0.50	SRVC TL	- 131.00
TABLE No. 000033	CT 1																
CHECK No. 1234																	
ST	.90.50																
1 DEPT01	.30.00																
1 DEPT02	.10.00																
+	.0.50																
SRVC TL	- 131.00																
Table#	33																
Item 1	Dept 1	\$30.00															
	Quantity	1															
Item 2	Dept 2	\$10.00															
	Quantity	1															

1 2 3 4 OLD CHECK

3 0 00 1

1 0 00 2

Insert slip

NB

Remove slip

- The table number is stored in the check tracking index memory so its input is not required in this operation even if table number input is preset as compulsory. Table number input after inputting the check number may be performed, however, without generating an error.
- Once a check is opened under a number in a certain mode (REG1 or REG2), the same mode must be used to make additions to the check.

Advanced Operations

Issuing a guest receipt

The following operation can be used to print out the balance of a temporarily finalized check.

Example

OPERATION	RECEIPT																								
<div style="display: flex; justify-content: space-around; align-items: center;"> 1 2 3 4 GUEST RECEIPT </div> <p style="margin-top: 5px;">Input the number of check you want.</p>	<table style="width: 100%; border-collapse: collapse;"> <tr> <td>TABLE No. 000033</td> <td style="text-align: right;">CT 1</td> </tr> <tr> <td>CHECK No. 1234</td> <td></td> </tr> <tr> <td>1 DEPT01</td> <td style="text-align: right;">.10.00</td> </tr> <tr> <td>1 DEPT01</td> <td style="text-align: right;">.10.00</td> </tr> <tr> <td>1 DEPT02</td> <td style="text-align: right;">.20.00</td> </tr> <tr> <td>1 DEPT02</td> <td style="text-align: right;">.20.00</td> </tr> <tr> <td>1 DEPT03</td> <td style="text-align: right;">.30.00</td> </tr> <tr> <td>+</td> <td style="text-align: right;">.0.50</td> </tr> <tr> <td>1 DEPT01</td> <td style="text-align: right;">.30.00</td> </tr> <tr> <td>1 DEPT02</td> <td style="text-align: right;">.10.00</td> </tr> <tr> <td>+</td> <td style="text-align: right;">.0.50</td> </tr> <tr> <td>SRVC TL</td> <td style="text-align: right;">- 131.00</td> </tr> </table>	TABLE No. 000033	CT 1	CHECK No. 1234		1 DEPT01	.10.00	1 DEPT01	.10.00	1 DEPT02	.20.00	1 DEPT02	.20.00	1 DEPT03	.30.00	+	.0.50	1 DEPT01	.30.00	1 DEPT02	.10.00	+	.0.50	SRVC TL	- 131.00
TABLE No. 000033	CT 1																								
CHECK No. 1234																									
1 DEPT01	.10.00																								
1 DEPT01	.10.00																								
1 DEPT02	.20.00																								
1 DEPT02	.20.00																								
1 DEPT03	.30.00																								
+	.0.50																								
1 DEPT01	.30.00																								
1 DEPT02	.10.00																								
+	.0.50																								
SRVC TL	- 131.00																								

Closing a check memory

Example

OPERATION	RECEIPT												
<div style="display: flex; justify-content: space-around; align-items: center;"> 1 2 3 4 OLD CHECK </div> <div style="display: flex; justify-content: space-around; align-items: center; margin-top: 5px;"> 1 5 0 00 CA / AMT / TEND </div>	<table style="width: 100%; border-collapse: collapse;"> <tr> <td>TABLE No. 000033</td> <td style="text-align: right;">CT 1</td> </tr> <tr> <td>CHECK No. 1234</td> <td></td> </tr> <tr> <td>ST</td> <td style="text-align: right;">.131.00</td> </tr> <tr> <td>TL</td> <td style="text-align: right;">- 131.00</td> </tr> <tr> <td>CASH</td> <td style="text-align: right;">.150.00</td> </tr> <tr> <td>C6</td> <td style="text-align: right;">.19.00</td> </tr> </table>	TABLE No. 000033	CT 1	CHECK No. 1234		ST	.131.00	TL	- 131.00	CASH	.150.00	C6	.19.00
TABLE No. 000033	CT 1												
CHECK No. 1234													
ST	.131.00												
TL	- 131.00												
CASH	.150.00												
C6	.19.00												

SLIP

REG	03-04-2000	17:05
C01	MC#01	000150
TABLE No.	000033	CT 1
CHECK No.	1234	
1	DEPT01	-10.00
1	DEPT01	-10.00
1	DEPT02	-20.00
1	DEPT02	-20.00
1	DEPT03	-30.00
	+	-0.50
#12	SRVC TL	-90.50
1	DEPT01	-30.00
1	DEPT02	-10.00
	+	-0.50
#16	SRVC TL	-131.00
	TL	-131.00
	CASH	-150.00
	CG	-19.00

New/old check key operation

Example 1

When a check number is input and <NEW/OLD> is pressed, the key works as a new check key function if there is no matching check number in the check tracking memory.

OPERATION

RECEIPT

Input a check number and press <NEW/OLD>.

CHECK No. 3456		
1	DEPT01	-10.00
1	DEPT02	-20.00
	+	-0.50
	SRVC TL	-30.50

Example 2

When a check number is input and <NEW/OLD> is pressed, the key works as an old check key if there is matching check number in the check tracking memory.

OPERATION

RECEIPT

CHECK No. 3456		
	ST	-30.50
	TL	-30.50
	CASH	-31.00
	CG	-0.50

Advanced Operations

Add check

This operation lets you combine the amounts of more than one check into a single check.

Example

Registration for check number 1234

Original check			OPERATION	RECEIPT																							
<table border="1" style="width: 100%; border-collapse: collapse;"> <tr> <td colspan="2">Check#</td> <td style="text-align: right;">1234</td> </tr> <tr> <td rowspan="2">Item 1</td> <td>Dept 1</td> <td style="text-align: right;">\$10.00</td> </tr> <tr> <td>Quantity</td> <td style="text-align: right;">1</td> </tr> <tr> <td rowspan="2">Item 2</td> <td>Dept 2</td> <td style="text-align: right;">\$20.00</td> </tr> <tr> <td>Quantity</td> <td style="text-align: right;">1</td> </tr> </table>			Check#		1234	Item 1	Dept 1	\$10.00	Quantity	1	Item 2	Dept 2	\$20.00	Quantity	1	<div style="display: flex; justify-content: space-around; margin-bottom: 5px;"> 1234NEW CHECK </div> <div style="display: flex; justify-content: space-around; margin-bottom: 5px;"> 33TABLE # </div> <div style="display: flex; justify-content: space-around; margin-bottom: 5px;"> 10001 </div> <div style="display: flex; justify-content: space-around; margin-bottom: 5px;"> 20002 </div> <div style="text-align: center; border: 1px solid black; padding: 2px;">NB</div>	<p>CHECK No. 1234</p> <table style="width: 100%; border-collapse: collapse;"> <tr> <td>TBL#</td> <td style="text-align: right;">000033</td> </tr> <tr> <td>1 DEPT01</td> <td style="text-align: right;">·10.00</td> </tr> <tr> <td>1 DEPT02</td> <td style="text-align: right;">·20.00</td> </tr> <tr> <td>+</td> <td style="text-align: right;">·0.50</td> </tr> <tr> <td>SRVC TL</td> <td style="text-align: right;">-30.50</td> </tr> </table>	TBL#	000033	1 DEPT01	·10.00	1 DEPT02	·20.00	+	·0.50	SRVC TL	-30.50
Check#		1234																									
Item 1	Dept 1	\$10.00																									
	Quantity	1																									
Item 2	Dept 2	\$20.00																									
	Quantity	1																									
TBL#	000033																										
1 DEPT01	·10.00																										
1 DEPT02	·20.00																										
+	·0.50																										
SRVC TL	-30.50																										

Registration for check number 3456

Added check			OPERATION	RECEIPT														
<table border="1" style="width: 100%; border-collapse: collapse;"> <tr> <td colspan="2">Check#</td> <td style="text-align: right;">3456</td> </tr> <tr> <td rowspan="2">Item</td> <td>Dept 1</td> <td style="text-align: right;">\$30.00</td> </tr> <tr> <td>Quantity</td> <td style="text-align: right;">1</td> </tr> </table>			Check#		3456	Item	Dept 1	\$30.00	Quantity	1	<div style="display: flex; justify-content: space-around; margin-bottom: 5px;"> 3456NEW CHECK </div> <div style="display: flex; justify-content: space-around; margin-bottom: 5px;"> 30001 </div> <div style="text-align: center; border: 1px solid black; padding: 2px;">NB</div>	<p>CHECK No. 3456</p> <table style="width: 100%; border-collapse: collapse;"> <tr> <td>1 DEPT01</td> <td style="text-align: right;">·30.00</td> </tr> <tr> <td>+</td> <td style="text-align: right;">·0.50</td> </tr> <tr> <td>SRVC TL</td> <td style="text-align: right;">-30.50</td> </tr> </table>	1 DEPT01	·30.00	+	·0.50	SRVC TL	-30.50
Check#		3456																
Item	Dept 1	\$30.00																
	Quantity	1																
1 DEPT01	·30.00																	
+	·0.50																	
SRVC TL	-30.50																	

Registration for check number 1234

Check No. : 1234		OPERATION	RECEIPT													
<div style="border: 1px solid black; padding: 5px; width: 100px; height: 50px; margin: 10px auto;"> Check No. : 3456 </div>	<div style="display: flex; justify-content: space-around; margin-bottom: 5px;"> 1234OLD CHECK </div> <div style="display: flex; justify-content: space-around; margin-bottom: 5px;"> 3456ADD CHECK </div> <div style="text-align: center; border: 1px solid black; padding: 2px;">NB</div>	<table style="width: 100%; border-collapse: collapse;"> <tr> <td>TABLE No. 000033</td> <td style="text-align: right;">CT 1</td> </tr> <tr> <td>CHECK No. 1234</td> <td></td> </tr> <tr> <td>ST</td> <td style="text-align: right;">·30.50</td> </tr> <tr> <td>ADD CHK</td> <td style="text-align: right;">3456</td> </tr> <tr> <td>ST</td> <td style="text-align: right;">·30.50</td> </tr> <tr> <td>+</td> <td style="text-align: right;">·0.50</td> </tr> <tr> <td>SRVC TL</td> <td style="text-align: right;">-61.50</td> </tr> </table>	TABLE No. 000033	CT 1	CHECK No. 1234		ST	·30.50	ADD CHK	3456	ST	·30.50	+	·0.50	SRVC TL	-61.50
TABLE No. 000033	CT 1															
CHECK No. 1234																
ST	·30.50															
ADD CHK	3456															
ST	·30.50															
+	·0.50															
SRVC TL	-61.50															

Separate check

This operation makes it possible to split a single check into separate checks.

Example

Check# 1234		
Item 1	Dept 1	\$10.00
	Quantity	1
Item 2	Dept 2	\$20.00
	Quantity	1
Item 3	Dept 3	\$30.00
	Quantity	1
Item 4	Dept 4	\$40.00
	Quantity	1

→

↗

Check# 3456		
Item 1	Dept 1	\$10.00
	Quantity	1
Item 2	Dept 3	\$30.00
	Quantity	1
Payment	Cash	\$40.00

OPERATION

RECEIPT

3 4 5 6 **NEW CHECK**

This input of a temporary check number can be skipped.

1 2 3 4 **SEPARATE CHECK**

Input the original check number by <SEP CHK>.

Display shows the 1st item which will be separated.

SEPARATE CHECK

After <SEP CHK>, this item is separated.

REVIEW

Display shows the 3rd item which will be separated.

SEPARATE CHECK

NB

4 0 00 **CA / AMT / TEND**

CHECK No. 3456	
SEP CHK	1234
1 DEPT01	. 10. 00
1 DEPT03	. 30. 00
TL	- 40. 00
CASH	. 40. 00
CG	. 0. 00

Advanced Operations

Clerk transfer

This operation lets you change the clerk who is in charge of a specific open check number.

Example

To change the clerk for check number 1234 from clerk 1 to clerk number 4.

OPERATION	RECEIPT									
<p style="text-align: right; margin-right: 20px;">CLK#</p> <p>Press this key if you do not want the clerk No. or clerk secret No. to appear on the display.</p> <p style="text-align: center; font-size: 24px; font-weight: bold;">1</p> <p style="text-align: right; margin-right: 20px;">CLK TRANS</p> <p>Input the clerk No. of the clerk who is currently in charge of check No. 1234 (target check).</p> <p style="text-align: center; font-size: 24px; font-weight: bold;">4</p> <p style="text-align: right; margin-right: 20px;">OP#</p> <p>Input the clerk No. of the clerk who will take over check No. 1234 (target check).</p> <p style="text-align: center; font-size: 24px; font-weight: bold;">1 2 3 4</p> <p style="text-align: right; margin-right: 20px;">NEW CHECK</p> <p>Input the target check No. that is transferred from clerk 1 to 4. You can use either <OLD CHK>, <NEW/OLD>. Note that if you skip this step, all check Nos currently assigned to clerk 1 are transferred to clerk 4.</p> <p style="text-align: right; margin-right: 20px;">CLK TRANS</p>	<table border="1" style="width: 100%; border-collapse: collapse;"> <tr> <td style="padding: 5px;">CLK TRANS</td> <td style="padding: 5px;">C04</td> <td style="padding: 5px;">Check No./NB amount</td> </tr> <tr> <td style="padding: 5px;">C01</td> <td style="padding: 5px;">1234</td> <td style="padding: 5px;">·60.50</td> </tr> <tr> <td colspan="2" style="border-top: 1px dashed black; padding: 5px;">TL</td> <td style="padding: 5px;">·60.50</td> </tr> </table>	CLK TRANS	C04	Check No./NB amount	C01	1234	·60.50	TL		·60.50
CLK TRANS	C04	Check No./NB amount								
C01	1234	·60.50								
TL		·60.50								

Table transfer

With this operation, you can change the number of a check.

Example 1

To change the check number 1234 to 1111 (which is newly opened).

Check No:
1234

1111 <CHK TRN>

Check No:
1234

Check No:
1111

OPERATION	RECEIPT										
<p style="font-size: 24px; font-weight: bold;">1 2 3 4</p> <p style="text-align: right; margin-right: 20px;">NEW CHECK</p> <p style="font-size: 24px; font-weight: bold;">1 0 0 0</p> <p style="text-align: right; margin-right: 20px;">1</p> <p style="font-size: 24px; font-weight: bold;">1 1 1 1</p> <p style="text-align: right; margin-right: 20px;">CHECK TRANS</p> <p>Input the new check No.</p>	<table border="1" style="width: 100%; border-collapse: collapse;"> <tr> <td style="padding: 5px;">CHECK No. 1234</td> <td style="padding: 5px;"></td> </tr> <tr> <td style="padding: 5px;">1 DEPT01</td> <td style="padding: 5px;">·10.00</td> </tr> <tr> <td style="padding: 5px;">ST</td> <td style="padding: 5px;">·10.00</td> </tr> <tr> <td style="padding: 5px;">TBL TRANS</td> <td style="padding: 5px;">1111</td> </tr> <tr> <td style="padding: 5px;">SRVC TL</td> <td style="padding: 5px;">- 10.00</td> </tr> </table>	CHECK No. 1234		1 DEPT01	·10.00	ST	·10.00	TBL TRANS	1111	SRVC TL	- 10.00
CHECK No. 1234											
1 DEPT01	·10.00										
ST	·10.00										
TBL TRANS	1111										
SRVC TL	- 10.00										

Example 2

To change the check number 3456 to 2222 (which has already been opened).

Check No:
3456

Check No:
2222

1111 <CHK TRN>

Check No:
3456

Check No:
2222

Added

OPERATION	RECEIPT										
<p style="font-size: 24px; font-weight: bold;">3 4 5 6</p> <p style="text-align: right; margin-right: 20px;">OLD CHECK</p> <p style="font-size: 24px; font-weight: bold;">1 0 0 0</p> <p style="text-align: right; margin-right: 20px;">1</p> <p style="font-size: 24px; font-weight: bold;">2 2 2 2</p> <p style="text-align: right; margin-right: 20px;">CHECK TRANS</p>	<table border="1" style="width: 100%; border-collapse: collapse;"> <tr> <td style="padding: 5px;">CHECK No. 3456</td> <td style="padding: 5px;"></td> </tr> <tr> <td style="padding: 5px;">ST</td> <td style="padding: 5px;">·10.00</td> </tr> <tr> <td style="padding: 5px;">1 DEPT01</td> <td style="padding: 5px;">·10.00</td> </tr> <tr> <td style="padding: 5px;">TBL TRANS</td> <td style="padding: 5px;">2222</td> </tr> <tr> <td style="padding: 5px;">SRVC TL</td> <td style="padding: 5px;">- 30.00</td> </tr> </table>	CHECK No. 3456		ST	·10.00	1 DEPT01	·10.00	TBL TRANS	2222	SRVC TL	- 30.00
CHECK No. 3456											
ST	·10.00										
1 DEPT01	·10.00										
TBL TRANS	2222										
SRVC TL	- 30.00										

Price reductions (red price)

You can use the reduced price function to change a price; generally to an amount that is less than the normal price. You can program the register so that it prints the normal price, and the difference between the two prices on the receipt, while on journal, these items are always printed.

The following functions are able to work with red price.

- Department and PLU
- Quantity extension (Preset price is required for both department and PLU.)
- Amount limitation of item program (It effects to new price.)

Note that you cannot use red price with the following types of item.



- Department and PLUs programmed with negative unit prices
- Set menus and link PLUs
- Second unit prices
- Multiplication operations that use the format: Amount × Quantity

Example 1

	OPERATION	RECEIPT																								
<table border="1" style="width: 100%; border-collapse: collapse;"> <tr> <td style="width: 15%;">Item</td> <td style="width: 15%;">Dept 1</td> <td style="width: 15%;">\$6.00</td> </tr> <tr> <td></td> <td style="text-align: center;">Red price</td> <td style="text-align: center;">\$4.00</td> </tr> <tr> <td>Payment</td> <td>Cash</td> <td>\$4.00</td> </tr> </table>	Item	Dept 1	\$6.00		Red price	\$4.00	Payment	Cash	\$4.00	<div style="display: flex; justify-content: space-around; align-items: center;"> <div style="border: 1px solid black; padding: 2px;">4</div> <div style="border: 1px solid black; padding: 2px;">00</div> <div style="border: 1px solid black; padding: 2px;">RED PRICE</div> </div> <p>Input a reduced price.</p> <div style="display: flex; justify-content: space-around; align-items: center;"> <div style="border: 1px solid black; padding: 2px;">6</div> <div style="border: 1px solid black; padding: 2px;">00</div> <div style="border: 1px solid black; padding: 2px;">1</div> </div> <div style="border: 1px solid black; padding: 2px; margin-top: 5px; width: fit-content; margin-left: auto;">CA/AMT /TEND</div>	<table border="1" style="width: 100%; border-collapse: collapse;"> <tr> <td style="width: 70%;">RED</td> <td style="width: 10%; text-align: right;">-6.00</td> <td style="width: 20%;"></td> </tr> <tr> <td>RED PRC</td> <td style="text-align: right;">-2.00</td> <td>Old price</td> </tr> <tr> <td>1 DEPT01</td> <td style="text-align: right;">*4.00</td> <td>Reduced price</td> </tr> <tr> <td>TL</td> <td style="text-align: right;">- 4.00</td> <td>New price (Difference between two prices)</td> </tr> <tr> <td>CASH</td> <td style="text-align: right;">-4.00</td> <td></td> </tr> </table>	RED	-6.00		RED PRC	-2.00	Old price	1 DEPT01	*4.00	Reduced price	TL	- 4.00	New price (Difference between two prices)	CASH	-4.00	
Item	Dept 1	\$6.00																								
	Red price	\$4.00																								
Payment	Cash	\$4.00																								
RED	-6.00																									
RED PRC	-2.00	Old price																								
1 DEPT01	*4.00	Reduced price																								
TL	- 4.00	New price (Difference between two prices)																								
CASH	-4.00																									

Example 2

	OPERATION	RECEIPT																								
<table border="1" style="width: 100%; border-collapse: collapse;"> <tr> <td style="width: 15%;">Item</td> <td style="width: 15%;">PLU 1</td> <td style="width: 15%;">\$4.00</td> </tr> <tr> <td></td> <td style="text-align: center;">Red price</td> <td style="text-align: center;">\$2.00</td> </tr> <tr> <td>Payment</td> <td>Cash</td> <td>\$6.00</td> </tr> </table>	Item	PLU 1	\$4.00		Red price	\$2.00	Payment	Cash	\$6.00	<div style="display: flex; justify-content: space-around; align-items: center;"> <div style="border: 1px solid black; padding: 2px;">3</div> <div style="border: 1px solid black; padding: 2px;">X/DATE TIME</div> </div> <div style="display: flex; justify-content: space-around; align-items: center;"> <div style="border: 1px solid black; padding: 2px;">2</div> <div style="border: 1px solid black; padding: 2px;">00</div> <div style="border: 1px solid black; padding: 2px;">RED PRICE</div> </div> <p>Input a reduced price.</p> <div style="display: flex; justify-content: space-around; align-items: center;"> <div style="border: 1px solid black; padding: 2px;">1</div> <div style="border: 1px solid black; padding: 2px;">PLU</div> </div> <div style="border: 1px solid black; padding: 2px; margin-top: 5px; width: fit-content; margin-left: auto;">CA/AMT /TEND</div>	<table border="1" style="width: 100%; border-collapse: collapse;"> <tr> <td style="width: 70%;">RED</td> <td style="width: 10%; text-align: right;">-12.00</td> <td style="width: 20%;"></td> </tr> <tr> <td>RED PRC</td> <td style="text-align: right;">-6.00</td> <td></td> </tr> <tr> <td>3 PLU0001</td> <td style="text-align: right;">*6.00</td> <td></td> </tr> <tr> <td>TL</td> <td style="text-align: right;">- 6.00</td> <td></td> </tr> <tr> <td>CASH</td> <td style="text-align: right;">-6.00</td> <td></td> </tr> </table>	RED	-12.00		RED PRC	-6.00		3 PLU0001	*6.00		TL	- 6.00		CASH	-6.00	
Item	PLU 1	\$4.00																								
	Red price	\$2.00																								
Payment	Cash	\$6.00																								
RED	-12.00																									
RED PRC	-6.00																									
3 PLU0001	*6.00																									
TL	- 6.00																									
CASH	-6.00																									

- The model for the U.S./Canada, use  instead of .

Condiment/preparation PLUs

You can force entering condiment or preparation PLU after the main PLU registration by programming.

Example (condiment PLU)

			OPERATION	RECEIPT												
Main item	PLU 1	\$10.00	<p>1 PLU</p> <p>Registering main PLU. No condiment registration occurs an error condition.</p> <p>1 1 PLU</p> <p>1 2 PLU</p> <p>1 3 PLU</p> <p>CA / AMT / TEND</p>	<table border="1"> <tr><td>1 PLU0001</td><td>·10.00</td></tr> <tr><td>PLU0011</td><td>·0.10</td></tr> <tr><td>PLU0012</td><td>·0.20</td></tr> <tr><td>PLU0013</td><td>·0.30</td></tr> <tr><td>TL</td><td>- 10.60</td></tr> <tr><td>CASH</td><td>·10.60</td></tr> </table>	1 PLU0001	·10.00	PLU0011	·0.10	PLU0012	·0.20	PLU0013	·0.30	TL	- 10.60	CASH	·10.60
1 PLU0001	·10.00															
PLU0011	·0.10															
PLU0012	·0.20															
PLU0013	·0.30															
TL	- 10.60															
CASH	·10.60															
Condiment	PLU 11	\$0.10														
	PLU 12	\$0.20														
	PLU 13	\$0.30														
Payment	Cash	\$10.60														

Example (preparation PLU)

			OPERATION	RECEIPT												
Main item	PLU 20	\$20.00	<p>2 0 PLU</p> <p>Registering main PLU.</p> <p>2 1 PLU</p> <p>2 2 PLU</p> <p>2 3 PLU</p> <p>CA / AMT / TEND</p>	<table border="1"> <tr><td>1 PLU0020</td><td>·20.00</td></tr> <tr><td>PLU0021</td><td></td></tr> <tr><td>PLU0022</td><td></td></tr> <tr><td>PLU0023</td><td></td></tr> <tr><td>TL</td><td>- 20.00</td></tr> <tr><td>CASH</td><td>·20.00</td></tr> </table>	1 PLU0020	·20.00	PLU0021		PLU0022		PLU0023		TL	- 20.00	CASH	·20.00
1 PLU0020	·20.00															
PLU0021																
PLU0022																
PLU0023																
TL	- 20.00															
CASH	·20.00															
Preparation	PLU 21	\$0.00														
	PLU 22	\$0.00														
	PLU 23	\$0.00														
Payment	Cash	\$20.00														

VAT breakdown printing

You can force printing of the VAT breakdown at the finalize stage, regardless of whether the cash register is programmed to print or skip printing of the VAT breakdown. Every time you want to have VAT breakdown, press <VAT>.

Example

OPERATION			RECEIPT			
Item 1	Dept 1	\$1.00	1 00 1	1 DEPT01	T1	-1.00
	Taxable	1		1 PLU0001	T2	-2.00
Item 2	PLU 1	(\$2.00)	1 PLU	TA1		-0.90
	Taxable	2		TX1		-0.10
Payment	Cash	\$3.00	VAT	TA2		-1.90
				TL		-0.10
			CA/AMT /TEND	CASH		-3.00

Deposit registrations

Use the following procedures to register deposits.

Deposit from customer

OPERATION			RECEIPT			
Deposit	Cash	\$50.00	5 0 00	DEPT0-		-50.00
				DEPOSIT -	TL	
			CA/AMT /TEND	CASH		-50.00

Deposit from customer during sales transaction

OPERATION			RECEIPT			
Items	Dept 1	\$10.00	1 0 00	1 DEPT01		-10.00
	Dept 2	\$20.00		1 DEPT02		-20.00
Deposit		\$20.00	2 0 00	DEPT0+		-20.00
				TL		-10.00
Payment	Cash	\$10.00	2 0 00	CASH		-10.00
			CA/AMT /TEND			

Bill copy

Example 1

To issue a copy of a bill dated February 1, 2004 in the amount of \$35.00 cash.

OPERATION	RECEIPT								
<div style="display: flex; justify-content: space-between; align-items: center;"> <div style="display: flex; gap: 5px;"> <div style="border: 1px solid black; padding: 2px 5px;">0</div> <div style="border: 1px solid black; padding: 2px 5px;">2</div> <div style="border: 1px solid black; padding: 2px 5px;">0</div> <div style="border: 1px solid black; padding: 2px 5px;">1</div> <div style="border: 1px solid black; padding: 2px 5px;">2</div> <div style="border: 1px solid black; padding: 2px 5px;">0</div> <div style="border: 1px solid black; padding: 2px 5px;">0</div> <div style="border: 1px solid black; padding: 2px 5px;">4</div> </div> <div style="border: 1px solid black; padding: 2px 5px; font-size: 8px;">BILL COPY</div> </div> <p style="text-align: center; font-size: 10px;">Enter date by date order.</p> <div style="display: flex; justify-content: space-between; align-items: center; margin-top: 10px;"> <div style="display: flex; gap: 5px;"> <div style="border: 1px solid black; padding: 2px 5px;">3</div> <div style="border: 1px solid black; padding: 2px 5px;">5</div> <div style="border: 1px solid black; padding: 2px 5px;">00</div> </div> <div style="border: 1px solid black; padding: 2px 5px; font-size: 8px;">CA/AMT TEND</div> </div>	<div style="border: 1px solid black; padding: 5px;"> <p style="font-size: 10px;">* BILL TOP MESSAGE 1 * * BILL TOP MESSAGE 2 * * BILL TOP MESSAGE 3 * * BILL TOP MESSAGE 4 *</p> <p style="font-size: 10px;">REG 02-01-2004(SUN) C01 MC#01</p> <p style="font-size: 10px;">* BILL COPY MESSAGE 1 * * BILL COPY MESSAGE 2 * * BILL COPY MESSAGE 3 * * BILL COPY MESSAGE 4 *</p> <table style="width: 100%; border-collapse: collapse; font-size: 10px;"> <tr> <td style="width: 80%;">TA1</td> <td style="text-align: right;">.35.00</td> </tr> <tr> <td>TX1</td> <td style="text-align: right;">.3.50</td> </tr> <tr> <td>TL</td> <td style="text-align: right;">- 38.50</td> </tr> <tr> <td>CASH</td> <td style="text-align: right;">.38.50</td> </tr> </table> <p style="font-size: 10px;">* BILL BTM MESSAGE 1 * * BILL BTM MESSAGE 2 * * BILL BTM MESSAGE 3 * * BILL BTM MESSAGE 4 *</p> </div> <div style="margin-left: 10px; font-size: 10px;"> <p>Bill top message *¹</p> <p>Bill copy message *¹</p> <p>Add-on tax amount</p> <p>Bill bottom message *¹</p> <p>*¹ Programmable option</p> </div>	TA1	.35.00	TX1	.3.50	TL	- 38.50	CASH	.38.50
TA1	.35.00								
TX1	.3.50								
TL	- 38.50								
CASH	.38.50								

Note that you can finalize this operation using the cash amount tendered key.

Example 2

To issue a copy of a bill dated February 1, 2004 in the amount of Euro 30.00 cash (sub-currency).

OPERATION	RECEIPT								
<div style="display: flex; justify-content: space-between; align-items: center;"> <div style="display: flex; gap: 5px;"> <div style="border: 1px solid black; padding: 2px 5px;">0</div> <div style="border: 1px solid black; padding: 2px 5px;">2</div> <div style="border: 1px solid black; padding: 2px 5px;">0</div> <div style="border: 1px solid black; padding: 2px 5px;">1</div> <div style="border: 1px solid black; padding: 2px 5px;">2</div> <div style="border: 1px solid black; padding: 2px 5px;">0</div> <div style="border: 1px solid black; padding: 2px 5px;">0</div> <div style="border: 1px solid black; padding: 2px 5px;">4</div> </div> <div style="border: 1px solid black; padding: 2px 5px; font-size: 8px;">BILL COPY</div> </div> <div style="display: flex; justify-content: space-between; align-items: center; margin-top: 10px;"> <div style="border: 1px solid black; padding: 2px 5px; font-size: 8px;">PD</div> </div> <div style="display: flex; justify-content: space-between; align-items: center; margin-top: 10px;"> <div style="display: flex; gap: 5px;"> <div style="border: 1px solid black; padding: 2px 5px;">3</div> <div style="border: 1px solid black; padding: 2px 5px;">0</div> <div style="border: 1px solid black; padding: 2px 5px;">00</div> </div> <div style="border: 1px solid black; padding: 2px 5px; font-size: 8px;">CA/AMT TEND</div> </div>	<div style="border: 1px solid black; padding: 5px;"> <p style="font-size: 10px;">* BILL TOP MESSAGE 1 * * BILL TOP MESSAGE 2 * * BILL TOP MESSAGE 3 * * BILL TOP MESSAGE 4 *</p> <p style="font-size: 10px;">REG 02-01-2004(SUN) C01 MC#01</p> <p style="font-size: 10px;">* BILL COPY MESSAGE 1 * * BILL COPY MESSAGE 2 * * BILL COPY MESSAGE 3 * * BILL COPY MESSAGE 4 *</p> <table style="width: 100%; border-collapse: collapse; font-size: 10px;"> <tr> <td style="width: 80%;">TA1</td> <td style="text-align: right;">27.28</td> </tr> <tr> <td>TX1</td> <td style="text-align: right;">2.72</td> </tr> <tr> <td>TL</td> <td style="text-align: right;">30.00</td> </tr> <tr> <td>CASH</td> <td style="text-align: right;">30.00</td> </tr> </table> <p style="font-size: 10px;">* BILL BTM MESSAGE 1 * * BILL BTM MESSAGE 2 * * BILL BTM MESSAGE 3 * * BILL BTM MESSAGE 4 *</p> </div> <div style="margin-left: 10px; font-size: 10px;"> <p>Bill top message *¹</p> <p>Bill copy message *¹</p> <p>Add-in tax amount</p> <p>Bill bottom message *¹</p> <p>*¹ Programmable option</p> </div>	TA1	27.28	TX1	2.72	TL	30.00	CASH	30.00
TA1	27.28								
TX1	2.72								
TL	30.00								
CASH	30.00								

Actual stock quantity inquiry

With this operation, you can recall the actual stock quantity for PLUs and show it on the display of the cash register.

Example

To check the actual stock quantity of PLU 32 and flat-PLU 001.

OPERATION	DISPLAY (7segment)
<div style="display: flex; flex-direction: column; align-items: center;"> <div style="display: flex; gap: 10px;"> <div style="border: 1px solid black; padding: 2px 5px;">3</div> <div style="border: 1px solid black; padding: 2px 5px;">2</div> <div style="border: 1px solid black; padding: 2px 5px;">PLU</div> </div> <div style="margin-top: 5px;"> <div style="border: 1px solid black; padding: 2px 5px;">STOCK INQ</div> <div style="border: 1px solid black; padding: 2px 5px;">STOCK INQ</div> <div style="border: 1px solid black; padding: 2px 5px;">001</div> </div> </div>	<div style="border: 1px solid black; padding: 5px; text-align: center; margin-bottom: 10px;">12345</div> <div style="border: 1px solid black; padding: 5px; text-align: center;">1</div> <p style="text-align: center; margin-top: 5px;">Actual stock quantity are appeared.</p>

Unit price inquiry

Use this operation to recall the unit prices of departments, PLUs, second unit price of PLUs, or scanning PLUs. The unit prices appear on the display of the cash register when recalled.

Example

To check the unit price of PLU 32, flat-PLU 001, department 1.

OPERATION	DISPLAY (7 segment)
<div style="display: flex; flex-direction: column; align-items: center;"> <div style="display: flex; gap: 10px;"> <div style="border: 1px solid black; padding: 2px 5px;">3</div> <div style="border: 1px solid black; padding: 2px 5px;">2</div> <div style="border: 1px solid black; padding: 2px 5px;">PLU</div> </div> <div style="margin-top: 5px;"> <div style="border: 1px solid black; padding: 2px 5px;">PRICE INQ</div> <div style="border: 1px solid black; padding: 2px 5px;">PRICE INQ</div> <div style="border: 1px solid black; padding: 2px 5px;">001</div> <div style="border: 1px solid black; padding: 2px 5px;">PRICE INQ</div> <div style="border: 1px solid black; padding: 2px 5px;">1</div> </div> </div>	<div style="border: 1px solid black; padding: 5px; text-align: center; margin-bottom: 10px;">145</div> <div style="border: 1px solid black; padding: 5px; text-align: center; margin-bottom: 10px;">3.00</div> <div style="border: 1px solid black; padding: 5px; text-align: center;">14.00</div>

Previous item void using <REVIEW>

You can correct the previously registered item(s) in the same transaction by using <REVIEW> (review key).

Example

	OPERATION	DISPLAY
Item 1	Dept. 1 \$2.35	1 ST ·2.35 DEPT01
	Quantity 1	2.35
Item 2	Dept. 2 \$2.00	2 ST ·4.35 DEPT02
	Quantity 1	2.00
Item 3	PLU 1 (\$1.20) _{preset}	3 ST ·5.55 PLU001
	Quantity 1	1.20
Corrected Item 1	Dept. 1 \$2.35	** REVIEW ** DEPT01 1 QT
	Quantity 1	2.35
Payment	Cash \$3.20	2 ST ·3.20 DEPT01
		-2.35
		CASH
		3.20

Review the item to be corrected.

Press <VOID> to correct.

RECEIPT

1 DEPT01	·2.35	*1
1 DEPT02	·2.00	
1 PLU0001	·1.20	
VOID	*1
1 DEPT01	-2.35	*1
TL	- 3.20	
CASH	·3.20	

*1 These items can be skipped by program.

Scanning PLU

Product barcodes are read by scanning with hand-held scanner, and are filed in the scanning PLU file together with the unit price, item descriptor, programming status, link department, totalizer and counter.

When a barcode is entered by scanning, or from the keyboard by using <OBR> (OBR key) or <One touch NLU> (One touch NLU key) and it has been filed in the scanning PLU file, the preset unit price is accumulated to its own totalizer and other appropriate totalizers.

Scanning PLUs include UPC-A/UPC-E/EAN-13/EAN-8, source marking, in-store marking code.

Item registration

By scanner/code input/one touch NLU key

OPERATION			RECEIPT			
Item 1 (scan)	Scan-PLU	(\$2.35)	<p>“Scanning”</p> <p>1 2 3</p> <p>4 5 6 OBR</p> <p>Scanning-PLU code and OBR key</p> <p>NLU</p> <p>One touch NLU</p> <p>CA/AMT/TEND</p>	1 Scan-PLU01	·2.34	Scanning PLU code *1
	PLU code	49012347		#49012347		
Item 2 (code)	Scan-PLU	(\$2.00)		1 Scan-PLU02	·2.00	
	PLU code	123456		#123456		
Item 3 (OTN)	Scan-PLU	(\$1.23)		1 Scan-PLU03	·1.23	*1 Programmable option
	PLU code	49012354		#49012354		
Payment	Cash	\$5.58	TL	- 5.58		
			CASH	·5.58		

Not found PLU

When a scanning PLU item which does not exist in the scanning PLU file is registered, an error occurs (Item not found error). In this case, you can input this item to the ECR and register it at the same time. After this operation, “Item not found error” does not occur during the next registration.

OPERATION			RECEIPT			
Item 1 (scan)	Scan-PLU	(\$1.00)	<p>“Scanning”</p> <p>Does not exist in the scanning PLU file</p> <p>“Not Found Error”</p> <p>1 0 0 1</p> <p>Input price and press the linked department key.</p> <p>“Scanning”</p> <p>Register normally.</p> <p>CA/AMT/TEND</p>	2 DEPT01	·2.00	Link department descriptor/amount
	PLU code	49012361		#49012361		
	Dept.	1		TL	- 2.00	
Item 2 (scan)	Scan-PLU	(\$1.00)		CASH	·2.00	
	PLU code	49012361				
Payment	Cash	\$2.00				

After daily operation, a “Not found PLU maintenance” is necessary to merge not found PLU(s) into the scanning PLU file. Please consult with your dealer in detail.

Programming to clerk

You can program up to 4-digit assigning number (clerk number), trainee status of clerk (i.e. training cashier) and commission rate for each clerk.

Programming clerk number

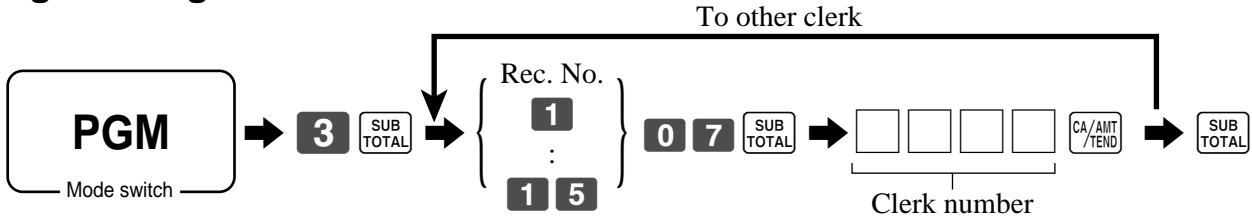

Programming trainee status

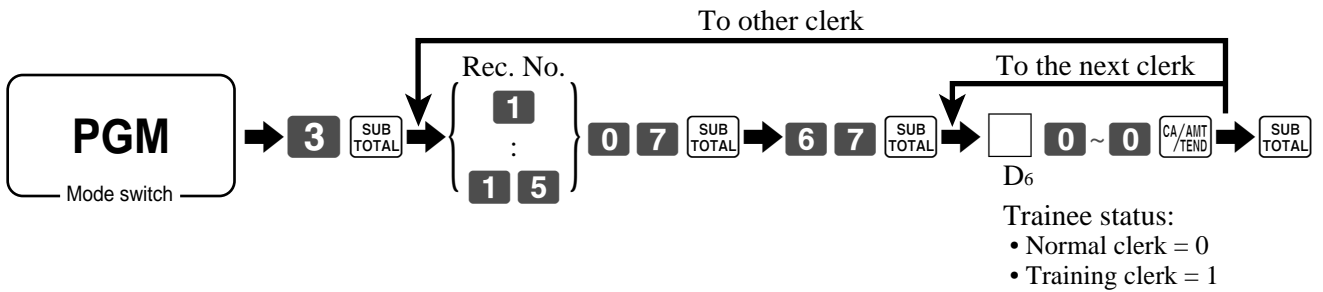

Programming commission rate

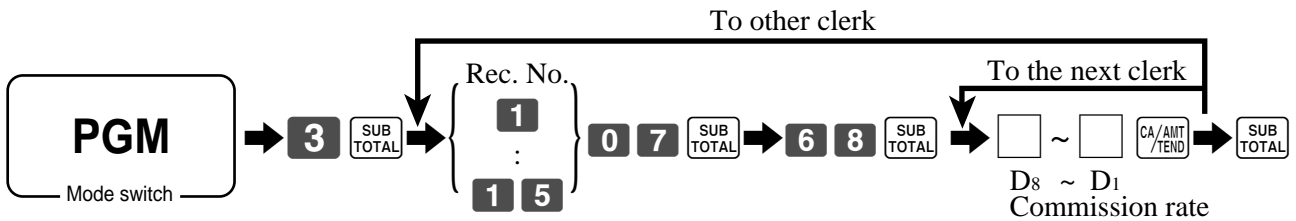

Record No.	Clerk number				Trainee status	Commission rate							
						Commission rate 1				Commission rate 2			
	D ₄	D ₃	D ₂	D ₁		D ₆	Integer		Decimal		Integer		Decimal
					D ₈	D ₇	D ₆	D ₅	D ₄	D ₃	D ₂	D ₁	
1						00000							
2						00000							
3						00000							
4						00000							
5						00000							
6						00000							
7						00000							
8						00000							
9						00000							
10						00000							
11						00000							
12						00000							
13						00000							
14						00000							
15						00000							

Character programming can be performed in two ways:

- Character keyboard programming (see page 95),
or
- Entering characters by code (see page 96).

Programming descriptors and messages

The following descriptors and messages can be programmed;

- Messages (Logo, commercial and bottom message)
- Clerk name
- PLU item descriptor
- Department key descriptor
- Machine number

Programming receipt message, machine No. and clerk name

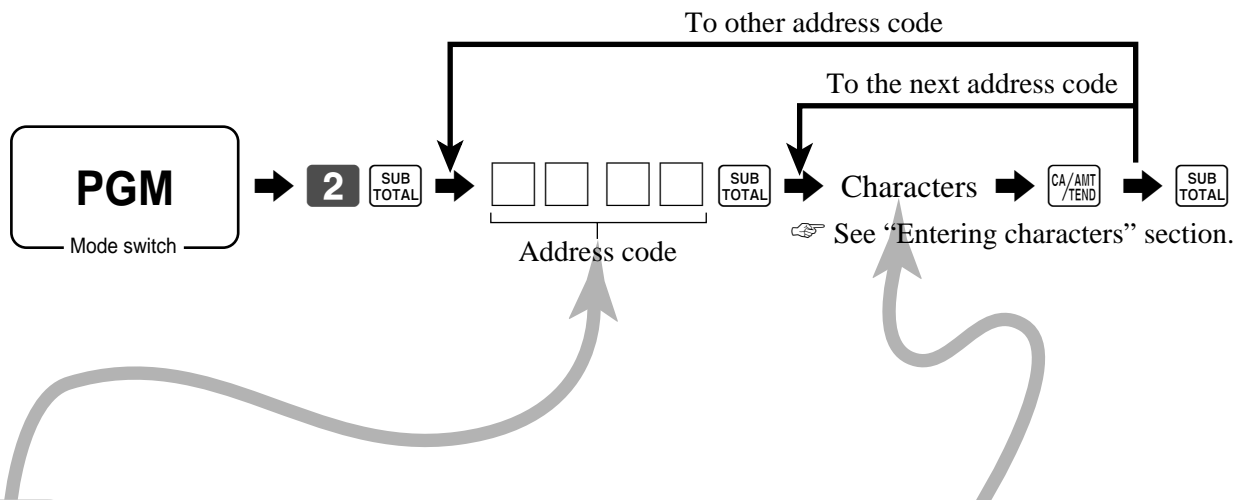

Address code	Contents	Initial character	Yours																			
0107	Clerk 01	C01																				
0207	Clerk 02	C02																				
0307	Clerk 03	C03																				
0407	Clerk 04	C04																				
0507	Clerk 05	C05																				
0607	Clerk 06	C06																				
0707	Clerk 07	C07																				
0807	Clerk 08	C08																				
0907	Clerk 09	C09																				
1007	Clerk 10	C10																				
1107	Clerk 11	C11																				
1207	Clerk 12	C12																				
1307	Clerk 13	C13																				
1407	Clerk 14	C14																				
1507	Clerk 15	C15																				
0191	Machine number	MC#01																				

Advanced Operations

Address code	Contents	Initial character	Yours
0132	1st line of logo message	YOUR RECEIPT	
0232	2nd line of logo message	THANK YOU	
0332	3rd line of logo message	CALL AGAIN	
0432	4th line of logo message		
0532	1st line of commercial message		
0632	2nd line of commercial message		
0732	3rd line of commercial message		
0832	4th line of commercial message		
0932	1st line of bottom message		
1032	2nd line of bottom message		
1132	3rd line of bottom message		
1232	4th line of bottom message		
1332	1st line of bill top message		
1432	2nd line of bill top message		
1532	3rd line of bill top message		
1632	4th line of bill top message		
1732	1st line of bill copy message		
1832	2nd line of bill copy message		
1932	3rd line of bill copy message		
2032	4th line of bill copy message		
2132	1st line of bill bottom message		
2232	2nd line of bill bottom message		
2332	3rd line of bill bottom message		
2432	4th line of bill bottom message		
2532	Post receipt message	DUPLICATE RECEIPT	
2632	1st line of guest intermediate msg.		
2732	2nd line of guest intermediate msg.		
2832	3rd line of guest intermediate msg.		
2932	4th line of guest intermediate msg.		
3032	1st line of guest bottom msg.		
3132	2nd line of guest bottom msg.		
3232	3rd line of guest bottom msg.		
3332	4th line of guest bottom msg.		
3432	5th line of guest bottom msg.		
3532	6th line of guest bottom msg.		
3632	7th line of guest bottom msg.		
3732	8th line of guest bottom msg.		
3832	9th line of guest bottom msg.		
3932	10th line of guest bottom msg.		

Programming department key descriptor

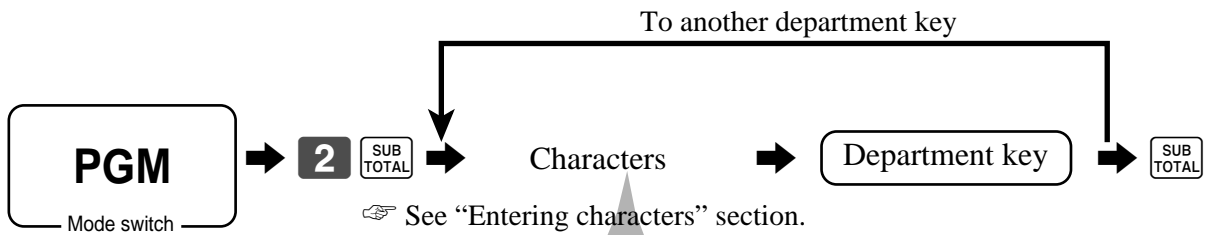

Contents	Initial character	Yours											
Department 01	DEPT01												
Department 02	DEPT02												
Department 03	DEPT03												
Department 04	DEPT04												
Department 05	DEPT05												
Department 06	DEPT06												
Department 07	DEPT07												
Department 08	DEPT08												
Department 09	DEPT09												
Department 10	DEPT 10												
Department 11	DEPT 11												
Department 12	DEPT 12												
Department 13	DEPT 13												
Department 14	DEPT 14												
Department 15	DEPT 15												
:	:												

Advanced Operations

Programming transaction key descriptor

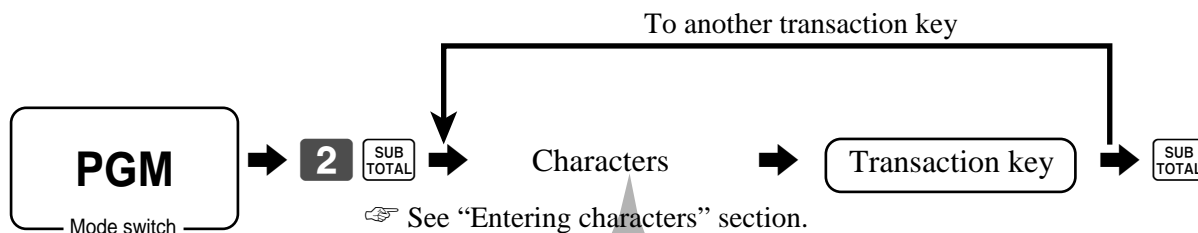

Contents	Initial character	Yours											
Cash / Amount tendered	CASH												
Charge	CHARGE												
Check	CHECK												
Credit 1	CREDIT 1												
Credit 2	CREDIT 2												
Received on account	RC												
Paid out	PD												
Minus	-												
Discount	%-												
Refund	RF												
Correction	CORR												
Receipt	RCT												
Non add / No sale	#/NS												
VAT	VAT												
Tax shift 1	T/S1												
Tax shift 2	T/S2												
Open	OPEN												
Clerk number	CLK#												
Subtotal	SUBTOTAL												
Receipt on / off	RCT ON/OFF												
Multiplication / Date time	X												
Multiplication / for / Date time	QT												
Two zero	00												
Decimal point	.												
Media change	MEDIA CHG												
PLU	PLU												
Price	PRC												
Coupon	COUPON												

Entering characters

In this section, the method to enter descriptors or messages (characters) to the cash register during programming is described.

Characters are specified by character keyboard or by codes. In the first half of this section, the usage of character keyboard is described. In the latter half, inputting method by character code is described.

Using character keyboard

Example:

Input “ **A** p p l e J u i c e ”,
 enter “DBL” “A” “SHIFT” “p” “p” “l” “e” “SPACE” “CAP” “J” “SHIFT” “u” “i” “c” “e” **00** .

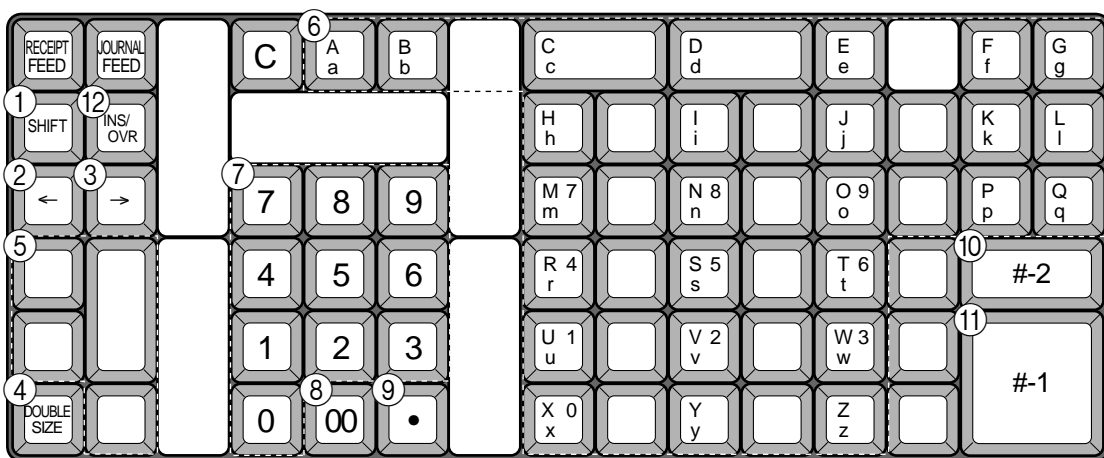

- ① **Shift key**
 Press this key to shift the following characters from the uppercase letter to lowercase letter and returns to the uppercase letter in sequence.
- ② **Left cursor key**
 Press this key to shift the character setting position to the left one by one. This key is used to correct already entered characters.
- ③ **Right cursor key**
 Press this key to shift the character setting position to the right one by one. This key is used to correct already entered characters.
- ④ **Double size letter key**
 Press this key to specify that the next character you input to a double size character.
- ⑤ **Space key**
 Press this key to set a space.
- ⑥ **Alphabet keys**
 Press these keys to input characters.
- ⑦ **Numeric keys**
 Press these keys to enter program codes, memory number and character codes.
- ⑧ **Character fixed key**
 Press this key to enter when the alphabetic entry for a descriptor, name or message has been completed.
- ⑨ **Backspace/Character code fixed key**
 Press this key to register one character with code (2 or 3 digit). It clears the last input character, much like a back space key. (Does not clear the double size letter key entry.)
- ⑩ **Program end key**
 Press this key to terminate the character programming.
- ⑪ **Character enter key**
 Press this key to register the programmed characters.
- ⑫ **Insert/Override key**
 Press this key to change the status “Insert” between the original characters or “Override” the original characters.

Advanced Operations

Entering characters by code

Every time you enter a character, choose character codes by the character code list (below) and press the  key to settle it. After you complete entering characters, press the **00** key to fix them.

Example:







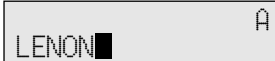
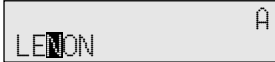

Input “ **A** p p l e J u i c e ”,
 enter “ 255  65  112  112  108  101  32  74  117  105  99  101  **00** ”

Character code list

Chara	Code	Chara	Code	Chara	Code	Chara	Code	Chara	Code	Chara	Code	Chara	Code
Space	32	0	48	@	64	P	80	'	96	p	112	Ç	128
!	33	1	49	A	65	Q	81	a	97	q	113	ü	129
"	34	2	50	B	66	R	82	b	98	r	114	é	130
#	35	3	51	C	67	S	83	c	99	s	115	â	131
\$	36	4	52	D	68	T	84	d	100	t	116	ä	132
%	37	5	53	E	69	U	85	e	101	u	117	à	133
&	38	6	54	F	70	V	86	f	102	v	118	å	134
'	39	7	55	G	71	W	87	g	103	w	119	ç	135
(40	8	56	H	72	X	88	h	104	x	120	ê	136
)	41	9	57	I	73	Y	89	i	105	y	121	ë	137
*	42	:	58	J	74	Z	90	j	106	z	122	è	138
+	43	;	59	K	75	[91	k	107	{	123	ï	139
,	44	<	60	L	76	\	92	l	108		124	î	140
-	45	=	61	M	77]	93	m	109	}	125	ì	141
.	46	>	62	N	78	^	94	n	110	~	126	Ä	142
/	47	?	63	O	79	_	95	o	111		127	Å	143
É	144	á	160	■	176	Ł	192	ø	208	Ó	224	-	240
æ	145	í	161	■	177	±	193	Ð	209	ß	225	±	241
Æ	146	ó	162	■	178	⌈	194	Ê	210	Ô	226	_	242
ô	147	ú	163		179	†	195	Ë	211	Ò	227	3/4	243
ö	148	ñ	164	†	180	—	196	È	212	ö	228	¶	244
ò	149	Ñ	165	Á	181	†	197		213	Õ	229	§	245
û	150	ª	166	Â	182	ã	198	í	214	µ	230	÷	246
ù	151	º	167	À	183	Ã	199	î	215	þ	231	¸	247
ÿ	152	¿	168	©	184	Ł	200	ï	216	Ɔ	232	°	248
Ö	153	®	169	†	185	ƒ	201	¸	217	Ú	233	ˆ	249
Ü	154	¬	170		186	±	202	ƒ	218	Û	234	•	250
ø	155	1/2	171	¬	187	⌈	203	■	219	Ù	235	¹	251
£	156	1/4	172	¸	188	†	204	■	220	ý	236	³	252
Ø	157	¡	173	¢	189	—	205		221	Ý	237	²	253
×	158	«	174	¥	190	†	206	ì	222	—	238	■	254
f	159	»	175	¡	191	¤	207	■	223	'	239	Double size	255

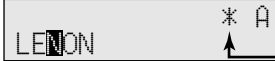

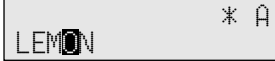







Editing characters

Correcting a character just entered











OPERATION	DISPLAY (dot)
“L” “E” “N” “O” “N”	
↩ Enter LENON, instead of LEMON.	
   ↩ Press left arrow key three times.	
 ↩ Override mode	
“M” ↩ Enter “M”.	

* means “OVR” mode.











Correcting and adding a PLU descriptor already set

OPERATION	DISPLAY (dot)
 ↩ Enter “00”.	
   ↩ Enter PLU No.	
“S” “o” “d” “a” “ ” ↩ Enter “Soda” and “space”.	
 ↩ Override mode	
“L” ↩ Enter “L”.	

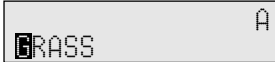
Correcting a key descriptor already set

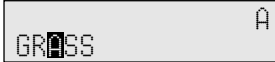
OPERATION	DISPLAY (dot)
 ↩ Enter “00”.	
 ↩ Designate an appropriate key.	
  ↩ Press right arrow key two times.	
“M” ↩ Enter “M”.	
 ↩ Delete “N”.	

Correcting a message descriptor already set

OPERATION	DISPLAY (dot)
     ↩ Enter record and file number.	
  ↩ Press right arrow key two times.	
“O” ↩ Enter “O”.	
 ↩ Delete “A”.	

Printing read/reset reports

• Daily sales read report (“X1” mode)

You can print read reports at any time during the business day without affecting the data stored in the cash register's memory.

• Daily sales reset report (“Z1” mode)

You should print reset reports at the end of the business day.

Important!

- The reset operation issues a report and also clears all sales data from the cash register's memory.
- Be sure to perform the reset operations at the end of each business day. Otherwise, you will not be able to distinguish between the sales data for different dates.

To print the individual department, PLU/flat-PLU read report

This report shows sales for specific departments or PLUs/flat-PLUs.

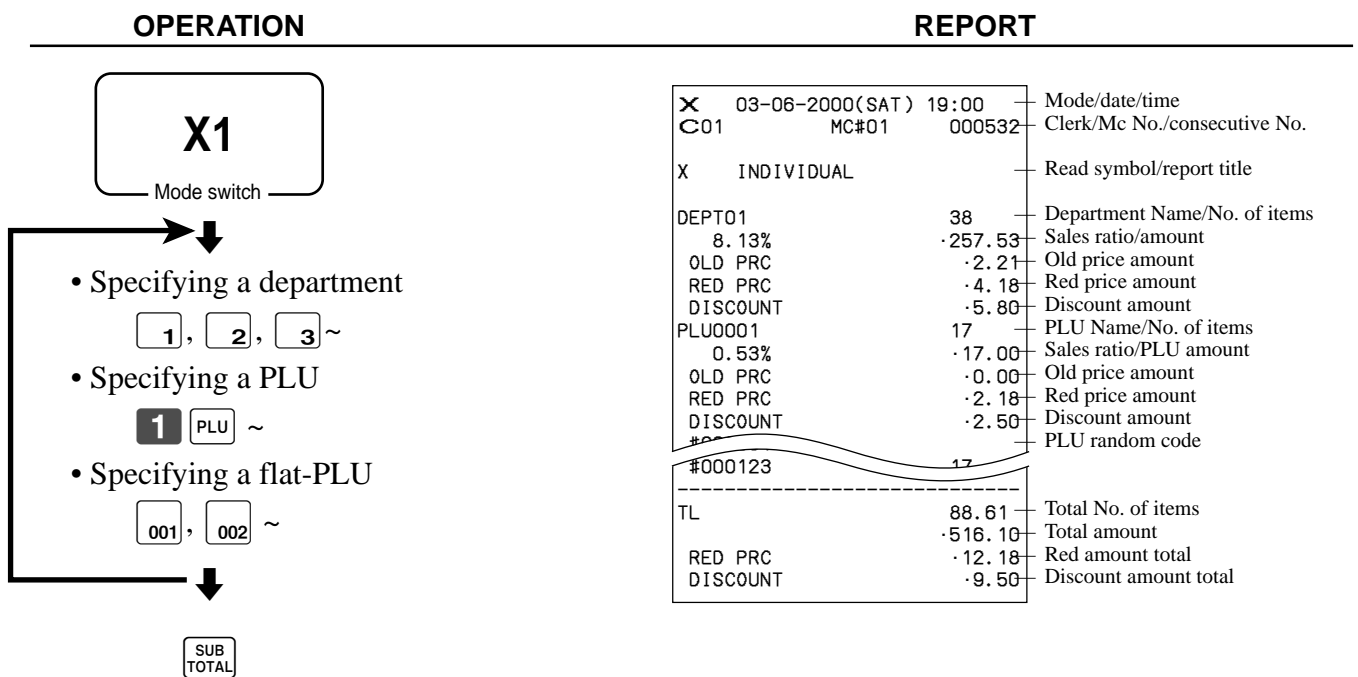

After you finish to select items, press

SUB
TOTAL

 to terminate.

To print the financial read report

This report shows gross sales, net sales, cash in drawer and check in drawer.

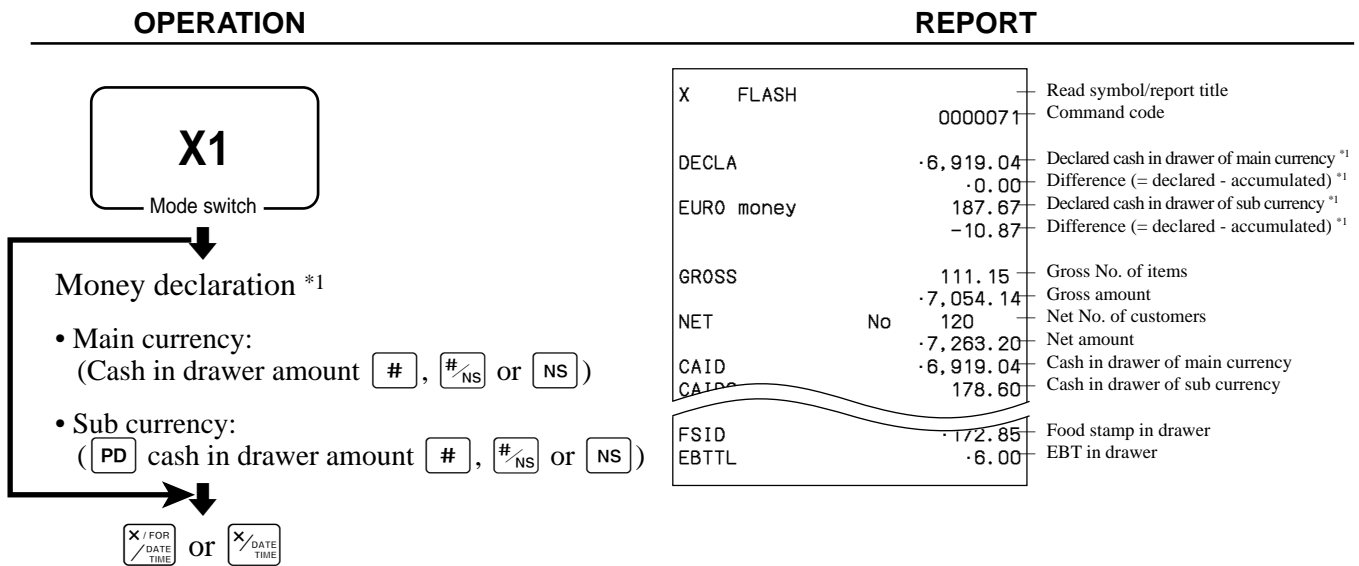

To print the individual clerk read/reset report

This report shows individual clerk totals.

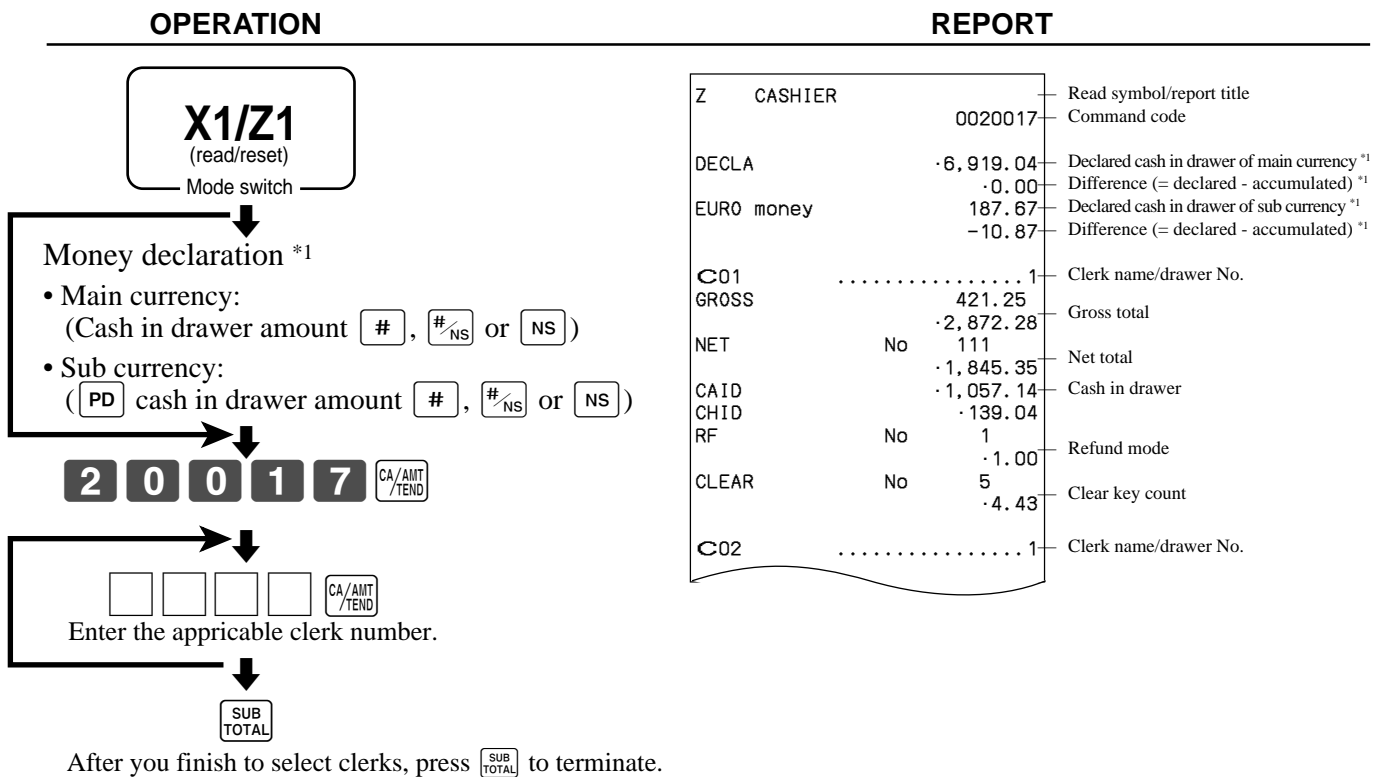

*1 Money declaration:

Count how much cash is in the drawer and input this amount (up to 10 digits).

The cash register will automatically compare the input with the cash in drawer in the memory and print the difference between these two amounts.

Note that if money declaration is required by programming, you cannot skip this procedure.

Advanced Operations

To print the daily sales read/reset report

This report shows sales except for PLUs.

OPERATION

REPORT

X1/Z1

(read/reset)

Mode switch

Money declaration *1

- Main currency:
(Cash in drawer amount #, #/NS or NS)
- Sub currency:
(PD cash in drawer amount #, #/NS or NS)

CA / AMT
/ TEND

Z	BATCH 01		Report title
Z	FIX	0001	Fixed total report title/reset counter *4
		0001011	Report code
DECLA		·6,919.04	Declared cash in drawer of main currency *1
		·0.00	Difference (= declared - accumulated) *1
EURO money		187.67	Declared cash in drawer of sub currency *1
		-10.87	Difference (= declared - accumulated) *1
GROSS		981.25	Gross total *3
		·6,574.40	
NET	No	111	Net total *3
		·7,057.14	
CAID		·6,919.04	Cash in drawer *3
CHID		·139.04	Charge in drawer *3
CKID		·859.85	Check in drawer *3
CRID(1)		·709.85	Credit in drawer *3
RF	No	3	Refund mode *3
		·10.22	
CUST	CT	111	Customer number *3
AVRG		·63.57	Average sales per customer *3
DC		·1.22	Discount total *3
REF		·2.42	Refund key *3
CLEAR	No	85	Clear key count *3
ROUND		·0.00	Rounding total *3
CANCEL	No	2	Cancellation *3
		·12.97	
TA1		·2,369.69	Taxable 1 amount *3
TX1		·128.86	Tax 1 amount *3
TA2		·2,172.96	Taxable 2 amount *3
TX2		·217.33	Tax 2 amount *3
GT1		·00000000125478.96	Grand total 1 *3
GT2		·00000000346284.23	Grand total 2 *3
GT3		·00000000123212.75	Grand total 3 *3

Z	TRANS		0001	Function key report title/reset counter
			0001012	Report code
CASH	No	362		Function key count/amount *2
		-1,638.04		
CHARGE	No	56		
		-1,174.85		
RC	No	4		
		-810.00		
PD	No	5		
		-520.00		
CORR	No	14		
		-39.55		
VLD	No	19		
RCT	No	3		
NS	No	5		

Z	DEPT		0001	Department report title/reset counter
			0001015	Report code
DEPT01		38		Department name/No. of items *2
	8.13%	-257.53		Sales ratio/amount *2
OLD PRC		-2.21		Old price amount *2
RED PRC		-4.18		Red price amount *2
DISCOUNT		-5.80		Discount amount *2
DEPT02		183		
		-1,362.28		
RED PRC		-20.21		
DISCOUNT		-17.22		

TL		88.61		Total No. of items
		-1,916.10		Total amount
RED PRC		-12.18		Red amount total
DISCOUNT		-9.50		Discount amount total

Z	CASHIER		0001	Clerk report title/reset counter
			0001017	Report code
C01	1		Clerk name/drawer No.
GROSS		421.25		Gross total
		-2,872.28		
NET	No	111		Net total
		-1,845.35		
CAID		-1,057.14		Cash in drawer
CHID		-139.04		
RF	No	1		Refund mode
		-1.00		
CLEAR	No	5		Clear key count
		-4.43		
C02	1		Clerk name/drawer No.

*1 Money declaration:

Count how much cash is in the drawer and input this amount (up to 10 digits).

The cash register will automatically compare the input with the cash in drawer in the memory and print the difference between these two amounts.

Note that if money declaration is required by programming, you cannot skip this procedure.

*2 Zero totalled departments/functions (the amount and item numbers are both zero) are not printed.

*3 These items can be skipped by programming.

4 The “” symbol is printed on the reset report, memory overflow occurred in the counter/totalizer.

Advanced Operations

To print the PLU/flat-PLU read/reset report

This report shows sales for PLUs.

OPERATION	REPORT																																																																																															
<div style="border: 1px solid black; padding: 5px; width: fit-content; margin: 0 auto;"> <p>X1/Z1 (read/reset)</p> <p>Mode switch</p> </div> <p style="text-align: center;">↓</p> <div style="display: flex; justify-content: center; gap: 10px;"> <div style="border: 1px solid black; padding: 2px 10px; font-weight: bold;">0</div> <div style="border: 1px solid black; padding: 2px 10px; font-weight: bold;">1</div> <div style="border: 1px solid black; padding: 2px 10px; font-weight: bold;">4</div> <div style="border: 1px solid black; padding: 2px 10px; font-size: 8px;">CA/AMT /TEND</div> </div>	<table border="1" style="width: 100%; border-collapse: collapse;"> <tr> <td style="width: 10%;">X</td> <td style="width: 40%;">PLU</td> <td style="width: 10%;"></td> <td style="width: 10%;"></td> <td style="width: 20%;">Read symbol/report title</td> </tr> <tr> <td></td> <td></td> <td></td> <td style="text-align: right;">0000014</td> <td>Report code</td> </tr> <tr> <td></td> <td>PLU0001</td> <td style="text-align: right;">17</td> <td></td> <td>PLU name/No. of items</td> </tr> <tr> <td></td> <td>0.53%</td> <td style="text-align: right;">.17.00</td> <td></td> <td>Sales ratio/PLU amount</td> </tr> <tr> <td></td> <td>OLD PRC</td> <td style="text-align: right;">.0.00</td> <td></td> <td>Old price amount</td> </tr> <tr> <td></td> <td>RED PRC</td> <td style="text-align: right;">.2.18</td> <td></td> <td>Red price amount</td> </tr> <tr> <td></td> <td>DISCOUNT</td> <td style="text-align: right;">.2.50</td> <td></td> <td>Discount amount</td> </tr> <tr> <td></td> <td>#000001</td> <td></td> <td></td> <td>PLU random code</td> </tr> <tr> <td></td> <td>PLU0100</td> <td style="text-align: right;">42</td> <td></td> <td></td> </tr> <tr> <td></td> <td>4.03%</td> <td style="text-align: right;">.69.00</td> <td></td> <td></td> </tr> <tr> <td></td> <td>OLD PRC</td> <td style="text-align: right;">.0.00</td> <td></td> <td></td> </tr> <tr> <td></td> <td>RED PRC</td> <td style="text-align: right;">.5.18</td> <td></td> <td></td> </tr> <tr> <td></td> <td>DISCOUNT</td> <td style="text-align: right;">.0.00</td> <td></td> <td></td> </tr> <tr> <td></td> <td>#000100</td> <td></td> <td></td> <td></td> </tr> <tr> <td colspan="5" style="text-align: center;">-----</td> </tr> <tr> <td></td> <td>TL</td> <td style="text-align: right;">188.61</td> <td></td> <td>Total No. of items</td> </tr> <tr> <td></td> <td></td> <td style="text-align: right;">.516.10</td> <td></td> <td>Total amount</td> </tr> <tr> <td></td> <td>RED PRC</td> <td style="text-align: right;">.12.18</td> <td></td> <td>Red amount total</td> </tr> <tr> <td></td> <td>DISCOUNT</td> <td style="text-align: right;">.9.50</td> <td></td> <td>Discount amount total</td> </tr> </table>	X	PLU			Read symbol/report title				0000014	Report code		PLU0001	17		PLU name/No. of items		0.53%	.17.00		Sales ratio/PLU amount		OLD PRC	.0.00		Old price amount		RED PRC	.2.18		Red price amount		DISCOUNT	.2.50		Discount amount		#000001			PLU random code		PLU0100	42				4.03%	.69.00				OLD PRC	.0.00				RED PRC	.5.18				DISCOUNT	.0.00				#000100				-----						TL	188.61		Total No. of items			.516.10		Total amount		RED PRC	.12.18		Red amount total		DISCOUNT	.9.50		Discount amount total
X	PLU			Read symbol/report title																																																																																												
			0000014	Report code																																																																																												
	PLU0001	17		PLU name/No. of items																																																																																												
	0.53%	.17.00		Sales ratio/PLU amount																																																																																												
	OLD PRC	.0.00		Old price amount																																																																																												
	RED PRC	.2.18		Red price amount																																																																																												
	DISCOUNT	.2.50		Discount amount																																																																																												
	#000001			PLU random code																																																																																												
	PLU0100	42																																																																																														
	4.03%	.69.00																																																																																														
	OLD PRC	.0.00																																																																																														
	RED PRC	.5.18																																																																																														
	DISCOUNT	.0.00																																																																																														
	#000100																																																																																															

	TL	188.61		Total No. of items																																																																																												
		.516.10		Total amount																																																																																												
	RED PRC	.12.18		Red amount total																																																																																												
	DISCOUNT	.9.50		Discount amount total																																																																																												

To print the hourly sales read/reset report

This report shows hourly breakdowns of sales.

OPERATION	REPORT																																																																																					
<div style="border: 1px solid black; padding: 5px; width: fit-content; margin: 0 auto;"> <p>X1/Z1 (read/reset)</p> <p>Mode switch</p> </div> <p style="text-align: center;">↓</p> <div style="display: flex; justify-content: center; gap: 10px;"> <div style="border: 1px solid black; padding: 2px 10px; font-weight: bold;">0</div> <div style="border: 1px solid black; padding: 2px 10px; font-weight: bold;">1</div> <div style="border: 1px solid black; padding: 2px 10px; font-weight: bold;">9</div> <div style="border: 1px solid black; padding: 2px 10px; font-size: 8px;">CA/AMT /TEND</div> </div>	<table border="1" style="width: 100%; border-collapse: collapse;"> <tr> <td style="width: 10%;">X</td> <td style="width: 40%;">HOURLY</td> <td style="width: 10%;"></td> <td style="width: 10%;"></td> <td style="width: 20%;">Read symbol/report title</td> </tr> <tr> <td></td> <td></td> <td></td> <td style="text-align: right;">0000019</td> <td>Report code</td> </tr> <tr> <td></td> <td>00:00->01:00</td> <td></td> <td></td> <td>Time range</td> </tr> <tr> <td></td> <td></td> <td style="text-align: right;">CT</td> <td style="text-align: right;">1</td> <td>No. of customers</td> </tr> <tr> <td></td> <td>GROSS</td> <td></td> <td style="text-align: right;">.1.10</td> <td>Gross sales amount</td> </tr> <tr> <td></td> <td>NET</td> <td style="text-align: right;">No</td> <td style="text-align: right;">1</td> <td>No. of receipt</td> </tr> <tr> <td></td> <td>1.90%</td> <td></td> <td style="text-align: right;">.1.20</td> <td>Sales ratio/net sales amount</td> </tr> <tr> <td></td> <td>23:00->00:00</td> <td></td> <td></td> <td></td> </tr> <tr> <td></td> <td></td> <td style="text-align: right;">CT</td> <td style="text-align: right;">1</td> <td></td> </tr> <tr> <td></td> <td>GROSS</td> <td></td> <td style="text-align: right;">.3.45</td> <td></td> </tr> <tr> <td></td> <td>NET</td> <td></td> <td style="text-align: right;">.1.00</td> <td></td> </tr> <tr> <td></td> <td>3.90%</td> <td></td> <td style="text-align: right;">.3.59</td> <td></td> </tr> <tr> <td colspan="5" style="text-align: center;">-----</td> </tr> <tr> <td></td> <td>TL</td> <td style="text-align: right;">CT</td> <td style="text-align: right;">280</td> <td>Total No. of customers</td> </tr> <tr> <td></td> <td>GROSS</td> <td></td> <td style="text-align: right;">.1,937.61</td> <td>Gross total amount</td> </tr> <tr> <td></td> <td>NET</td> <td style="text-align: right;">No</td> <td style="text-align: right;">25</td> <td>Total No. of receipt</td> </tr> <tr> <td></td> <td></td> <td></td> <td style="text-align: right;">.2,096.80</td> <td>Net total amount</td> </tr> </table>	X	HOURLY			Read symbol/report title				0000019	Report code		00:00->01:00			Time range			CT	1	No. of customers		GROSS		.1.10	Gross sales amount		NET	No	1	No. of receipt		1.90%		.1.20	Sales ratio/net sales amount		23:00->00:00						CT	1			GROSS		.3.45			NET		.1.00			3.90%		.3.59		-----						TL	CT	280	Total No. of customers		GROSS		.1,937.61	Gross total amount		NET	No	25	Total No. of receipt				.2,096.80	Net total amount
X	HOURLY			Read symbol/report title																																																																																		
			0000019	Report code																																																																																		
	00:00->01:00			Time range																																																																																		
		CT	1	No. of customers																																																																																		
	GROSS		.1.10	Gross sales amount																																																																																		
	NET	No	1	No. of receipt																																																																																		
	1.90%		.1.20	Sales ratio/net sales amount																																																																																		
	23:00->00:00																																																																																					
		CT	1																																																																																			
	GROSS		.3.45																																																																																			
	NET		.1.00																																																																																			
	3.90%		.3.59																																																																																			

	TL	CT	280	Total No. of customers																																																																																		
	GROSS		.1,937.61	Gross total amount																																																																																		
	NET	No	25	Total No. of receipt																																																																																		
			.2,096.80	Net total amount																																																																																		

To print the monthly sales read/reset report

This report shows monthly breakdowns of sales.

OPERATION	REPORT																																																																																				
<div style="border: 1px solid black; padding: 5px; width: fit-content; margin: 0 auto;"> X1/Z1 (read/reset) Mode switch </div> <div style="text-align: center; margin: 5px 0;">↓</div> <div style="display: flex; justify-content: center; align-items: center; gap: 10px;"> <div style="border: 1px solid black; padding: 2px 10px; font-weight: bold;">0</div> <div style="border: 1px solid black; padding: 2px 10px; font-weight: bold;">2</div> <div style="border: 1px solid black; padding: 2px 10px; font-weight: bold;">0</div> <div style="border: 1px solid black; padding: 2px 5px; font-size: 8px;">CA/AMT /TEND</div> </div>	<table border="1" style="width: 100%; border-collapse: collapse;"> <tr> <td style="width: 10%;">X</td> <td style="width: 40%;">MONTHLY</td> <td style="width: 10%;">0000020</td> <td style="width: 40%;">Read symbol/report title</td> </tr> <tr> <td></td> <td></td> <td></td> <td>Report code</td> </tr> <tr> <td></td> <td>1.....</td> <td></td> <td>Date of a month</td> </tr> <tr> <td></td> <td>GROSS</td> <td>1236.76</td> <td>Gross symbol/No. of items</td> </tr> <tr> <td></td> <td></td> <td>· 12,202.57</td> <td>Gross sales amount</td> </tr> <tr> <td></td> <td>NET</td> <td>No 214</td> <td>Net symbol/No. of customers</td> </tr> <tr> <td></td> <td></td> <td>· 12,202.57</td> <td>Net sales amount</td> </tr> <tr> <td colspan="4" style="text-align: center;">-----</td> </tr> <tr> <td></td> <td>01.....</td> <td></td> <td></td> </tr> <tr> <td></td> <td>GROSS</td> <td>2132</td> <td></td> </tr> <tr> <td></td> <td></td> <td>· 14,187.57</td> <td></td> </tr> <tr> <td></td> <td>NET</td> <td>No 205</td> <td></td> </tr> <tr> <td></td> <td></td> <td>· 13,398.76</td> <td></td> </tr> <tr> <td colspan="4" style="text-align: center;">-----</td> </tr> <tr> <td></td> <td>TL</td> <td></td> <td>Total symbol</td> </tr> <tr> <td></td> <td>GROSS</td> <td>9746.63</td> <td>Gross symbol/No. of items</td> </tr> <tr> <td></td> <td></td> <td>· 161,022.49</td> <td>Gross sales amount</td> </tr> <tr> <td></td> <td></td> <td>· 16.52</td> <td>Average daily gross sales</td> </tr> <tr> <td></td> <td>NET</td> <td>No 2351</td> <td>Net symbol/No. of customers</td> </tr> <tr> <td></td> <td></td> <td>· 161,022.49</td> <td>Net sales amount</td> </tr> <tr> <td></td> <td></td> <td>· 68.49</td> <td>Average daily net sales</td> </tr> </table>	X	MONTHLY	0000020	Read symbol/report title				Report code		1.....		Date of a month		GROSS	1236.76	Gross symbol/No. of items			· 12,202.57	Gross sales amount		NET	No 214	Net symbol/No. of customers			· 12,202.57	Net sales amount	-----					01.....				GROSS	2132				· 14,187.57			NET	No 205				· 13,398.76		-----					TL		Total symbol		GROSS	9746.63	Gross symbol/No. of items			· 161,022.49	Gross sales amount			· 16.52	Average daily gross sales		NET	No 2351	Net symbol/No. of customers			· 161,022.49	Net sales amount			· 68.49	Average daily net sales
X	MONTHLY	0000020	Read symbol/report title																																																																																		
			Report code																																																																																		
	1.....		Date of a month																																																																																		
	GROSS	1236.76	Gross symbol/No. of items																																																																																		
		· 12,202.57	Gross sales amount																																																																																		
	NET	No 214	Net symbol/No. of customers																																																																																		
		· 12,202.57	Net sales amount																																																																																		

	01.....																																																																																				
	GROSS	2132																																																																																			
		· 14,187.57																																																																																			
	NET	No 205																																																																																			
		· 13,398.76																																																																																			

	TL		Total symbol																																																																																		
	GROSS	9746.63	Gross symbol/No. of items																																																																																		
		· 161,022.49	Gross sales amount																																																																																		
		· 16.52	Average daily gross sales																																																																																		
	NET	No 2351	Net symbol/No. of customers																																																																																		
		· 161,022.49	Net sales amount																																																																																		
		· 68.49	Average daily net sales																																																																																		

To print the group read/reset report

This report shows PLU/subdepartment/department group totals.

OPERATION	REPORT																																																								
<div style="border: 1px solid black; padding: 5px; width: fit-content; margin: 0 auto;"> X1/Z1 (read/reset) Mode switch </div> <div style="text-align: center; margin: 5px 0;">↓</div> <div style="display: flex; justify-content: center; align-items: center; gap: 10px;"> <div style="border: 1px solid black; padding: 2px 10px; font-weight: bold;">0</div> <div style="border: 1px solid black; padding: 2px 10px; font-weight: bold;">1</div> <div style="border: 1px solid black; padding: 2px 10px; font-weight: bold;">6</div> <div style="border: 1px solid black; padding: 2px 5px; font-size: 8px;">CA/AMT /TEND</div> </div>	<table border="1" style="width: 100%; border-collapse: collapse;"> <tr> <td style="width: 10%;">X</td> <td style="width: 40%;">GROUP</td> <td style="width: 10%;">0000016</td> <td style="width: 40%;">Read symbol/report title</td> </tr> <tr> <td></td> <td></td> <td></td> <td>Report code</td> </tr> <tr> <td></td> <td>GROUP01</td> <td>203.25</td> <td>Group No./No. of items</td> </tr> <tr> <td></td> <td>33.87%</td> <td>· 1,108.54</td> <td>Sales ratio/group amount</td> </tr> <tr> <td></td> <td>GROUP02</td> <td>183</td> <td></td> </tr> <tr> <td></td> <td>40.58%</td> <td>· 1,327.80</td> <td></td> </tr> <tr> <td></td> <td>GROUP03</td> <td>12</td> <td></td> </tr> <tr> <td></td> <td></td> <td>· 13.25</td> <td></td> </tr> <tr> <td colspan="4" style="text-align: center;">-----</td> </tr> <tr> <td></td> <td>GROUP99</td> <td>13</td> <td></td> </tr> <tr> <td></td> <td>0.54%</td> <td>· 17.80</td> <td></td> </tr> <tr> <td colspan="4" style="text-align: center;">-----</td> </tr> <tr> <td></td> <td>TL</td> <td>862</td> <td>Group total No. of items</td> </tr> <tr> <td></td> <td></td> <td>· 3,272.00</td> <td>Group total amount</td> </tr> </table>	X	GROUP	0000016	Read symbol/report title				Report code		GROUP01	203.25	Group No./No. of items		33.87%	· 1,108.54	Sales ratio/group amount		GROUP02	183			40.58%	· 1,327.80			GROUP03	12				· 13.25		-----					GROUP99	13			0.54%	· 17.80		-----					TL	862	Group total No. of items			· 3,272.00	Group total amount
X	GROUP	0000016	Read symbol/report title																																																						
			Report code																																																						
	GROUP01	203.25	Group No./No. of items																																																						
	33.87%	· 1,108.54	Sales ratio/group amount																																																						
	GROUP02	183																																																							
	40.58%	· 1,327.80																																																							
	GROUP03	12																																																							
		· 13.25																																																							

	GROUP99	13																																																							
	0.54%	· 17.80																																																							

	TL	862	Group total No. of items																																																						
		· 3,272.00	Group total amount																																																						

Advanced Operations

• Periodic sales read report (“X2” mode)

You can print read reports at any time during the business day without affecting the data stored in the cash register's memory.

• Periodic sales reset report (“Z2” mode)

You should print reset reports at the end of the business day.

To print the periodic 1/2 sales read/reset reports

These reports show sales breakdowns of sales by any two kinds of period you want.

OPERATION

REPORT

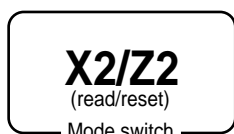

ZZ1 BATCH 02			Report title
ZZ1 FIX		0001	Fixed total report title/reset counter
		0001111	Report code
GROSS		981.25	Gross total *2
NET	No	111	Net total *2
		-6,574.40	
CAID		-7,057.14	Cash in drawer *2
CHID		-6,919.04	Charge in drawer *2
CKID		-139.04	Check in drawer *2
CRID(1)		-859.85	Credit in drawer *2
		-709.85	
RF	No	3	Refund mode *2
		-10.22	
CUST	CT	111	Customer number *2
AVRG		-63.57	Average sales per customer *2
DC		-1.22	Discount total *2
REF		-2.42	Refund key *2
CLEAR	No	85	Clear key count *2
ROUND		-0.00	Rounding total *2
CANCEL	No	2	Cancellation *2
		-12.97	
TA1		-2,369.69	Taxable 1 amount *2
TX1		-128.86	Tax 1 amount *2
TA2		-2,172.96	Taxable 2 amount *2
TX2		-217.33	Tax 2 amount *2
ZZ1 TRANS		0001	Function key report title/reset counter
		0001112	Report code
CASH	No	362	Function key count/amount *1
		-1,638.04	
CHARGE	No	56	
		-1,174.85	
RC	No	4	
		-810.00	
PD	No	5	
		-5.00	
CORR		14	
		-39.55	
VLD	No	19	
RCT	No	3	
NS	No	5	

ZZ1 DEPT		0001	Department report title/reset counter
		0001115	Report code
DEPT01		38	Department Name/No. of items *1
8.13%		.257.53	Sales ratio/amount *1
OLD PRC		.2.21	Old price amount *1
RED PRC		.4.18	Red price amount *1
DISCOUNT		.5.80	Discount amount *1
DEPT02		183	
		.1,362.26	
		.123.21	
DISCOUNT		.7.22	

TL		88.61	Total No. of items
		.1,916.10	Total amount
RED PRC		.12.18	Red amount total
DISCOUNT		.9.50	Discount amount total

ZZ1 CASHIER		0001	Clerk report title/reset counter
		0001117	Report code
C01	1	Clerk name/drawer No.
GROSS		421.25	Gross total
		.2,872.28	
NET	No	111	Net total
		.1,845.35	
CAID		.1,057.14	Cash in drawer
CHID		.139.04	
RF	No	1	Refund mode
		.1.00	
CLEAR	No	5	Clear key count
		.4.43	
C02	1	Clerk name/drawer No.

*1 Zero totalled departments/functions (the amount and item numbers are both zero) are not printed.

*2 These items can be skipped by programming.

Advanced Operations

To print other sales read/reset reports

The following reports can be issued.

Procedure

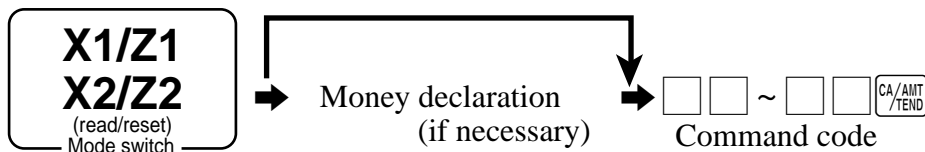

Report/command code list

Report name	Command code			Report name	Command code		
	# = 0 (read)	# = 1 (reset)			# = 0 (read)	# = 1 (reset)	
	Daily	Periodic 1	Periodic 2		Daily	Periodic 1	Periodic 2
Fix totalizer	11	#111	#211	Department	15	#115	#215
Transaction key	12	#112	#212	best 50 (amount order)	60015	60115	60215
Subdepartment	13	#113	#213	best 50 (quantity order)	70015	70115	70215
PLU by record number (all) *	14	#114	#214	Group	16	#116	#216
all PLU by random code *	14	#114	#214	Clerk	17	#117	#217
by group	1000014	100#114	100#214	individual	20017	2#117	2#217
by department	2000014	200#114	200#214	Hourly sales	19	#119	#219
by subdepartment	3000014	300#114	300#214	Monthly sales	20	#120	#220
individual by group	1020014	102#114	102#214	Open check	25	----	----
individual by department	2020014	202#114	202#214	total	40025	----	----
individual by subdepartment	3020014	302#114	302#214	Scanning PLU by range department (all)	26	----	----
range by record number *	10014	1#114	1#214	by range group	1000026	----	----
range by random code *	10014	1#114	1#214	by range department	2000026	----	----
best 50 (amount order)	60014	60114	60214	by range subdepartment	3000026	----	----
best 50 (quantity order)	70014	70114	70214	best 50 by range department	80026	----	----
menu (1st)	81	#181	#281	inactive item by range department	90026	----	----
menu (2nd)	82	#182	#282	Not found PLU by range department (all)	27	----	----
menu (3rd)	83	#183	#283	Table analysis	28	#128	#228
menu (4th)	84	#184	#284	Hourly item	31	#131	#231
menu (5th)	85	#185	#285	Mix & match	61	#161	#261
menu (6th)	86	#186	#286	Financial	71	----	----
PLU stock all PLU by record number *	64	----	----	Individual (item / transaction key)	No code	----	----
all by random PLU code *	64	----	----	PLU reset (no report)	50014	51114	51214
by group	1000064	----	----	Scanning PLU reset (no report)	50026	----	----
by department	2000064	----	----	Not found PLU reset (no report)	50027	----	----
by subdepartment	3000064	----	----	Not found PLU file reset (incl. program)	80027	----	----
individual by group	1020064	----	----	Not found PLU maintenance file reset	80082	----	----
individual by department	2020064	----	----				
individual by subdepartment	3020064	----	----				
range by record number *	10064	----	----				
range by random code *	10064	----	----				

* You can choose by record number / random code by program.

Reading the cash register's program

To print unit price/rate program (except PLU/scanning PLU)

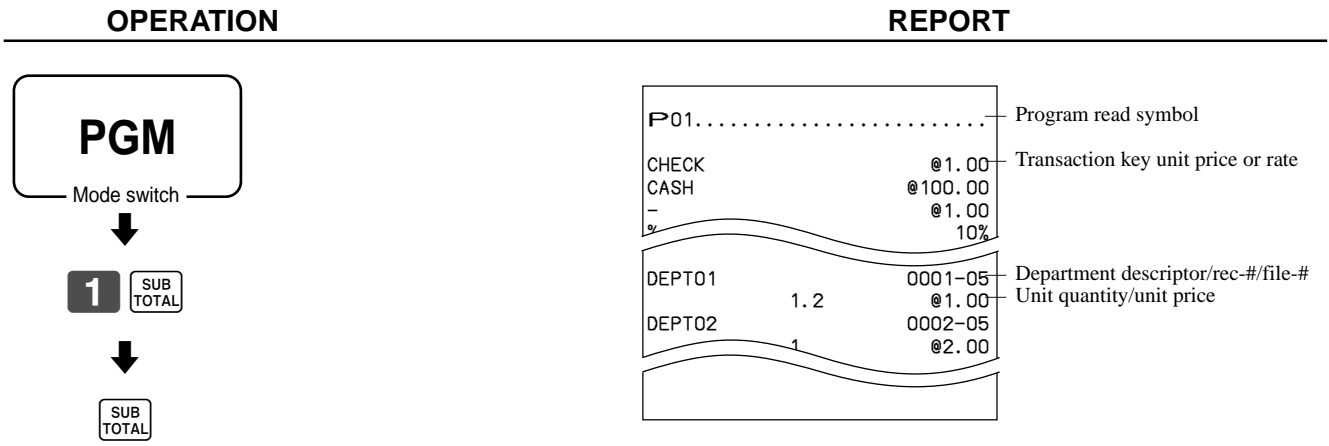

Advanced Operations

To print key descriptor, name, message program (except PLU)

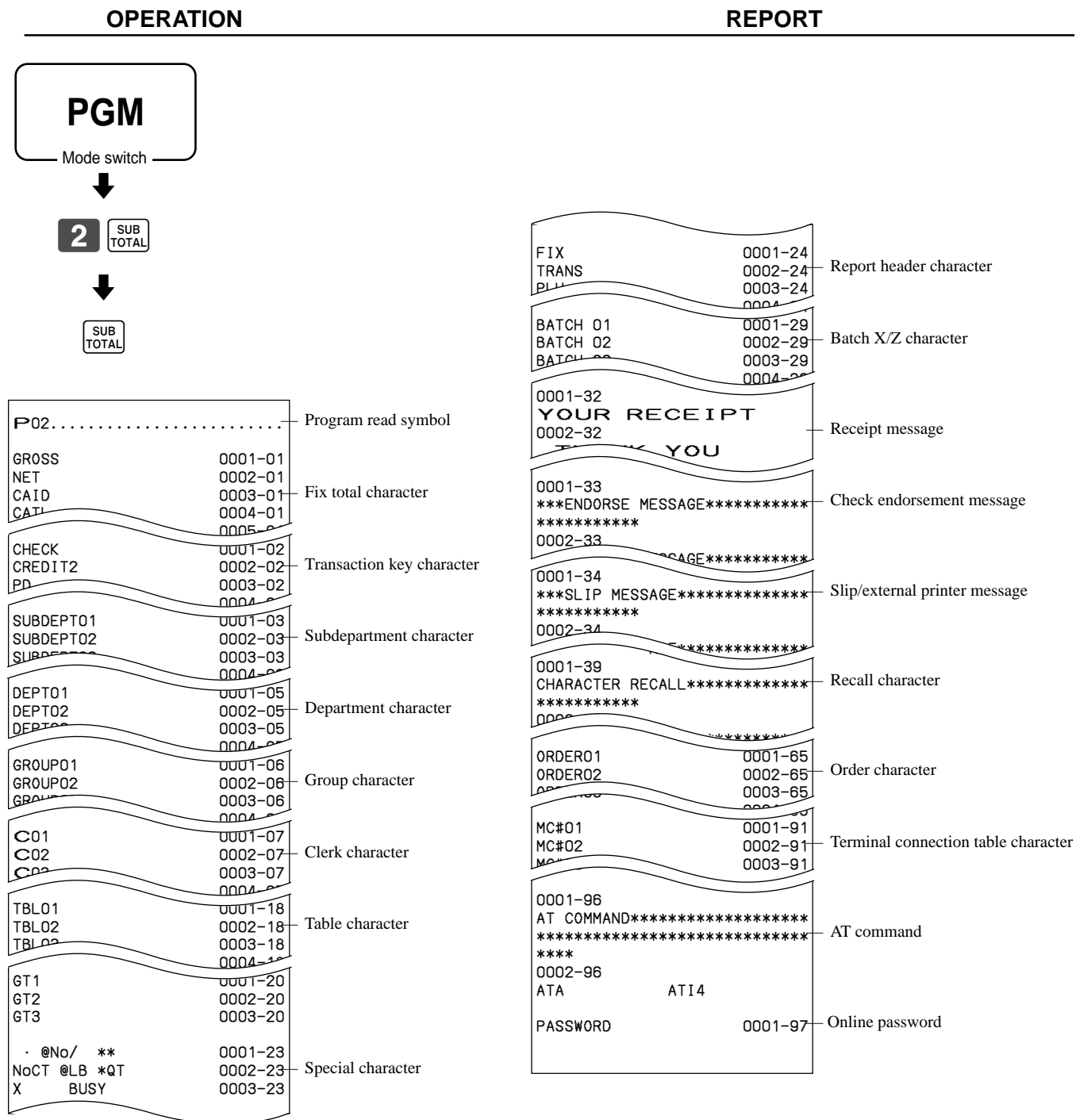

To print the PLU/flat-PLU program

OPERATION

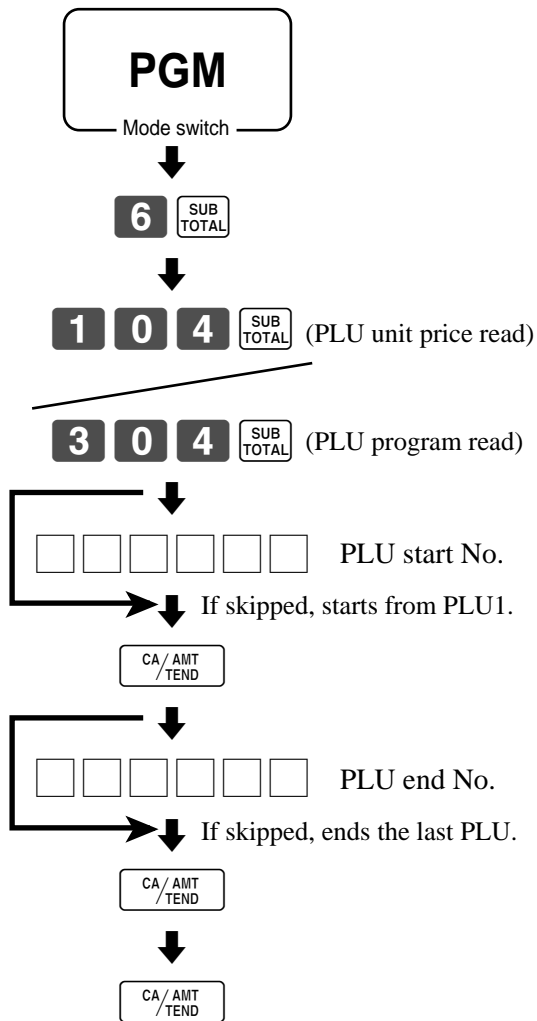

REPORT

P01.....	Program read symbol
#000001 - #999999	Read range
PLU0001	0001-04 Item character/rec-#/file-#
	#000001 Random code
1.2	@1.00 Unit quantity/unit price
PLU0002	0002-04
	#000002
1	@2.00

P03.....	Program read symbol
#000001 - #999999	Read range
PLU0001	0001-04 Item character/rec-#/file-#
	0000000000000000 Batch program 01 ~ 1066, 18 ~ 1966
11-66	000000 Batch program 1166
12-66	#000001 Batch program 1266
13-66	<- 0001-28 Batch program 1366
14-66	0 Batch program 1466
15-66	@1234.56 Batch program 1566
16-66	000000 Batch program 1666
17-66	00 Batch program 1766
PLU0002	0002-04
	0000000000000000
11-66	000000

Troubleshooting

This section describes what to do when you have problems with operation.

When an error occurs

Errors are indicated by an error codes. When this happens, you can usually find out what the problem is as illustrated below.

Press **C** and check the appropriate section of this manual for the operation you want to perform.

Error code	Message	Meaning	Action
E001	Wrong mode	Mode switch position changed before finalization.	Return the mode switch to its original setting and finalize the operation.
E003	Wrong operator	Clerk button pressed before finalization of a registration being performed under another clerk button. The signed on clerk differs from the clerk performed the tracking check registration.	Press the original clerk button and finalize the transaction before pressing another clerk button. Input correct check number or assign the proper clerk number.
E004	Error INIT/FC	Initialization or unit lock clear operation in progress.	Complete operation.
E005	Insufficient memory	Memory allocation exceeds total memory capacity.	Reallocate memory or expand memory (if possible).
E008	Please sign on	Registration without entering a clerk number.	Enter a clerk number.
E009	Enter password	Operation without entering the password.	Enter password.
E010	Close the drawer	The drawer is left open longer than the program time (drawer open alarm).	Close the drawer.
E011	Close the drawer	Attempt to register while the cash drawer is open.	Shut the cash drawer.
E015	Check R/J printer	Printer error	
E016	Change back to REG mode	Two consecutive transactions attempted in the refund mode.	Switch to another mode and then back to the RF mode for the next transaction.
E017	Enter CHK/TBL number	Attempt made to register an item without inputting a check number.	Input a check number.
E018	Enter Table number	Attempt made to register an item without inputting a table number.	Input a table number.
E019	Enter number of customers	Finalize operation attempted without entering the number of customer.	Enter the number of customer.
E021	No Dept Link	No department linked PLU is registered.	Correct the program.
E023	Stock shortage	Actual stock quantity becomes less than the minimum stock quantity.	Perform stock maintenance.
E024	No stock	Actual stock quantity becomes/is negative.	Perform stock maintenance.
E025	Illegal scale read or entry	Scale read error/perform non-scale registration to scalable item.	Retry registration/register to a proper department or PLU.
E026	Enter condiment/preparation PLU	No condiment/preparation PLU is registered.	Register condiment/preparation PLU.
E029	In the tender operation	Item registration is prohibited, while partial tender.	Finalize the transaction.
E030	Press RATE TAX key	Finalization of a transaction attempted without registering rate-tax.	Register <RATE TAX>.
E031	Press ST key	Finalization of a transaction attempted without confirming the subtotal.	Press <SUBTOTAL>.
E032	Press FSST key	Finalization of a transaction attempted without confirming of the food stamp subtotal.	Press <FS/ST>.
E033	Enter tendered amount	Finalize operation attempted without entering amount tender.	Enter the amount tendered.
E035	Change amount exceeds limit	Change amount exceeds preset limit.	Input amount tendered again.
E036	Remove money from the drawer	Contents of the drawer exceed programmed limit.	Perform pick up operation.
E037	Digit or amount limitation over	High amount lock out/low digit lock out error	Enter correct amount.
E038	Perform money declaration	Read/reset operation without declaring cash in drawer. This error appears only when this function is activated.	Perform money declaration.
E040	Issue guest receipt	Attempt to register a new transaction without issuing a guest receipt.	Issue a guest receipt.
E041	Print validation	Attempt to register a new transaction without validation.	Perform validation operation.
E042	Insert VLD paper and retry	Validation paper (slip printer) has run out.	Insert new validation paper.
E044	Print cheque	Attempt to register a new transaction without printing check.	Perform check print.
E045	Print Check Endorsement	Attempt to register a new transaction without printing check endorsement.	Perform check endorsement.

Troubleshooting

Error code	Message	Meaning	Action
E046	REG buffer full	Registration buffer full. Separate check buffer full.	Finalize the transaction. Allocate sufficient separate check buffer.
E047	Print bill	Attempt to register a new transaction without printing slip.	Perform slip printing operation.
E048	Insert slip paper and retry	No paper is inserted or paper is out in the slip printer.	Insert new slip paper.
E049	CHECK memory full	Check tracking index memory full.	Finalize and close the check number currently used.
E050	DETAIL memory full	Check tracking detail memory full.	Finalize and close the check number currently used.
E051	CHK/TBL No. is occupied	Attempt to made use <New Check> to open a new check using a number that is already used for an existing check in check tracking memory.	Finalize and close the check that is currently under the number that you want to use or use a different check number.
E053	CHK/TBL No. is not opened	Attempt made to use <Old Check> reopen a new check using a number that is not used for an existing check in check tracking memory.	Use the correct check number (if you want to reopen a check that already exists in check tracking memory) or use <New Check> to open a new check.
E054	Out of CHK/TBL No. range	Check number range over.	Enter correct number.
E055	In the SEP CHK operation	Normal registration is prohibited during separate check operation.	Terminate separate check operation.
E059	Press EAT-IN or TAKE-OUT key	Attempt to finalize a transaction without specifying <EAT-IN> or <TAKE-OUT>.	Press <EAT-IN> or <TAKE-OUT>.
E060	Printer offline	External printer offline	
E061	Printer error	External printer went down.	
E062	Printer paper end	External printer paper end	Replace new paper.
E063	Printer busy	External printer is now printing.	
E064	Print buffer full	Printing buffer full	
E066	Print from the beginning of the transaction	Attempt to print the last separated transaction on slip.	Print from the beginning of the transaction
E075	Negative balance cannot be finalized	Attempt to finalize a transaction when balance is less than or equal to zero.	Register item(s) until the balance becomes positive amount.
E085	Data exist in consolidation file	Data exists in the consolidation file.	Clear the data.
E099	Check NFP items	Disable to read/reset or consolidate the not found PLU item.	
E100	Operate at the master terminal	Prohibit master operation.	Perform it at master terminal.
E101	PLU maintenance file full. Press <#2> to exit	Scanning PLU direct maintenance/batch maintenance file becomes full.	Terminate the maintenance.
E105	PLU file full	Scanning PLU/not found PLU file full	
E106	Item exists in the PLU FILE	The designated item has already existed in the scanning PLU file.	Modify the designated item.
E121	Inline startup error	Network startup error.	
E139	Negative balance is not allowed	Attempt to register <-> or <CPN> when the balance becomes negative.	Enter proper minus/coupon amount.
E140	Wrong menu	This sheet holder is prohibited by PGM.	Set correct sheet holder.
E146	Arrangement file full	Arrangement file is full.	Set the arrangement properly.
E200	Insert CF card	No CF card is set.	Set CF card.
E203	Insufficient memory	Insufficient memory in the CF card.	Use a vacant (formatted) CF card.
E205	File already exist.	Can not write, because designated file has already been in the CF card.	Check the operation and retry.

When the register does not operate at all

Perform the following check whenever the cash register enter an error condition as soon as you switch it on. The results of this check are required by service personnel, so be sure to perform this check before you contact a CASIO representative for servicing.

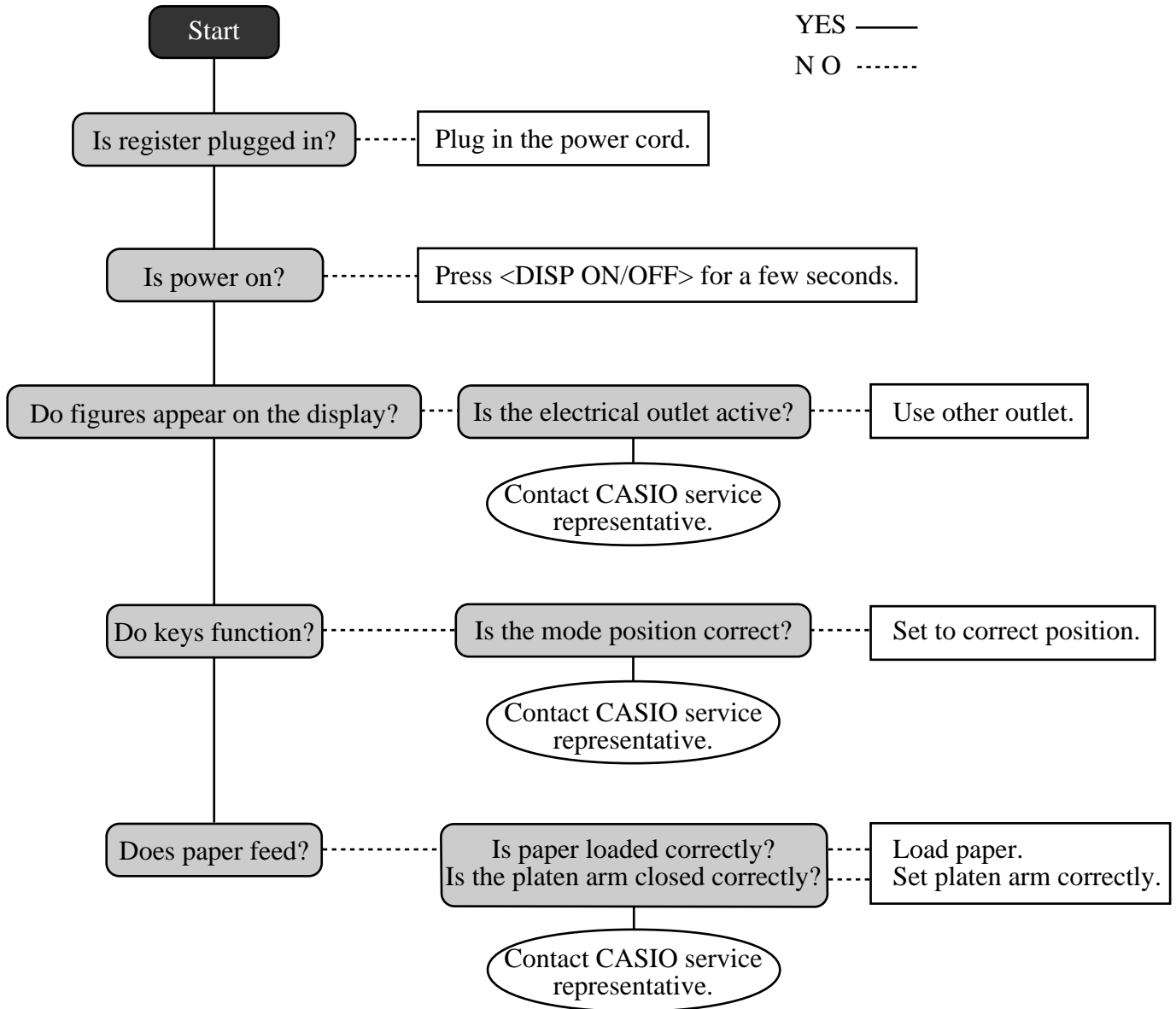

Clearing a machine lock up

If you make a mistake in operation, the cash register may lock up to avoid damage to programs and preset data. Should it happens, you can use the following procedure to clear the lock up without losing any data.

- 1 Power off the register.
- 2 Insert the PGM key in the mode switch.
- 3 Press down **RECEIPT FEED**, and turn the mode switch to PGM mode.
- 4 The display shows ten Fs, then release **RECEIPT FEED**.
- 5 Press **SUB TOTAL**. The display shows ten Fs and issue a receipt.

Important!

- If the register does not show ten Fs, never press **SUB TOTAL** and call service representative.

In case of power failure

If the power supply to the cash register is cut by a power failure or any other reason, simply wait for power to be restored. The details of any on-going transaction as well as all sales data in memory are protected by the memory backup batteries.

- Power failure during a registration
The subtotal for items registered up to the power failure is retained in memory. You will be able to continue with the registration when power is restored.
- Power failure during printing a read/reset report
The data already printed before the power failure is retained in memory. You will be able to issue a report when power is restored.
- Power failure during printing of a receipt and the journal
Printing will resume after power is restored. A line that was being printed when the power failure occurred is printed in full.
- Other
The power failure symbol is printed and any item that was being printed when the power failure occurred is reprinted in full.

The memory protection battery is constantly charging and discharging as you switch the cash register on and off during normal operations. This causes the capacity of the battery to decrease after approximately five years of use.

Important !

- Remember a weak battery has the potential of losing valuable transaction data.
- A label on the back of the cash register shows the normal service period of the battery installed in your cash register.
- Have the battery replaced by your dealer within the period noted on this label.

To replace journal paper

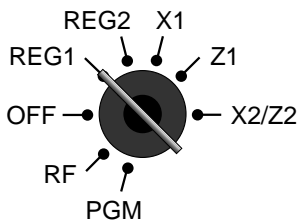

Step 1

Turn the mode switch to REG1 position.



Step 2

Remove the printer cover. (If the cover is locked, unlock by using the printer cover key before this step.)



Step 6

Slide the printed journal from the take-up reel.



Step 3

Press **JOURNAL FEED** to feed about 20 cm of paper.



Step 7

Open the platen arm.



Step 4

Cut the journal paper at the point where nothing is printed.



Step 8

Remove the old paper roll from the cash register.



Step 5

Remove the journal take-up reel from its holder.

Step 9

Load new paper. Go to the step 3 described on page 14 of this manual.

To replace receipt paper

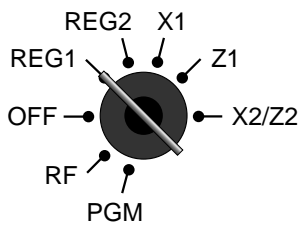

Step 1

Turn the mode switch to REG1 position.

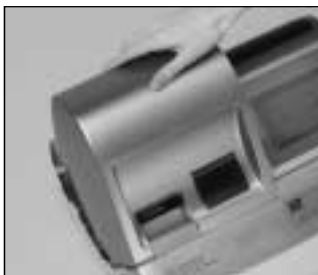

Step 2

Remove the printer cover.
(If the cover is locked, unlock by using the printer cover key before this step.)



Step 3

Open the platen arm.



Step 4

Remove the old paper roll from the cash register.

Step 5

Load new paper.
Go to the step 3 described on page 13 of this manual.

Options

Wetproof cover: WT-77
Memory chip: RK-3
Hand held scanner: HHS-15
Inline board : I/O-PB17
(Except for the U.S. and Canada)

Slip printer: SP-1300
Cable: PRT-CB-8C
Power Supply: 31AD-U or 31AD-E
External printer: UP-350, UP-250
Cable: PRT-CB-8A or PRT-CB-8B
Power supply: PS-180 and AC-170

Consult with your CASIO dealer for details.

Specifications

Input method

Entry: 10-key system, buffer memory 8 keys (2-key roll over)
 Department: Full key system

Display

Main: Amount 10 digits (zero suppression); No. of repeats, total, change, receipt on/off, transaction indicator
 Descriptor 16 digits × 2 lines; item descriptor, No. of items, mode, clerk name
 Customer: Amount 10 digits (zero suppression): total, change indicator

Printer

Receipt: Thermal alpha-numeric system 29 digits, receipt on/off switch (key)
 Store name or slogan is printed automatically
 Graphic logo: 20 (H) × 53 (W) mm
 Journal: Thermal alpha-numeric system 29 digits
 Automatic take up roll winding
 Paper roll: 58 (W) × 83 (D) mm
 Paper feed: Separate for receipt and journal
 Print speed: About 20 l/s

Listing capacity

Amount: 99999999
 Quantity: 9999.999
 Tendered amount: 9999999999
 Percent: 99.99
 Tax rate: 9999.9999
 Numbers: 9999999999999999

Chronological data

Date print: Automatic date printout on receipt or journal, automatic calendar
 Time print: Automatic time printout on receipt or journal, 24-hour system/12-hour system

Alarm

Key catch tone, error alarm, sentinel alarm

Memory protection battery

48-hour full charge protects memories for approximately 90 days.
 Battery should be replaced every five years.

Power supply/power consumption

See the rating plate.

Operation temperature

0°C ~ 40°C (32°F ~ 104°F)

Humidity

10 ~ 90%

Dimensions and weight

215mm (H) × 410mm (W) × 491mm (D) / 8kg ...without drawer
 (8 15/32" (H) × 16 5/32" (W) × 19 11/32" (D) / 17lbs. 10oz.) ...without drawer

Totalizers	Contents						
	Category	No. of totalizers	Amount (10 digits)	No. of items (6 integer/3 decimal)	Count (4 digits)	No. of customers (6 digits)	Periodic totalizers
Department	Up to 30	✓	✓				✓
PLU	Up to 200	✓	✓				
Clerk	15	✓	✓	✓	✓	✓	✓
Hourly sales	24	✓				✓	
Monthly sales	31	✓	✓			✓	
Transaction	Variable with program						✓
Non ressettable grand total	3	✓ (16 digits)					
Reset counter	12/15				✓		
Consecutive No.	1				✓ (6 digits)		

* Specifications and design are subject to change without notice.

- A**
- add check 24, 80
 - adding to a check 77
 - addition (+) 54
 - alphabet key 95
 - arrangement 24, 61
 - assigning a clerk 28
- B**
- backlight color control 20
 - backspace key 95
 - bill copy 24, 86
 - bottle link 60
 - bottle return 24, 60
 - bottom message 26, 91
- C**
- cancel 22, 24, 49
 - cash/amount tendered 23, 41
 - change 30
 - character code 96
 - character code fixed key 95
 - character enter key 95
 - character fixed key 95
 - character keyboard 95
 - charge 23
 - check 23, 41
 - check endorsement 24
 - check print 24
 - check tracking 76
 - clearing a machine lock up 113
 - clerk button 19, 28
 - clerk interrupt 52
 - clerk key 28
 - clerk key/button/lock 19, 28
 - clerk lock 28
 - clerk name 28, 91
 - clerk number 23, 90
 - clerk read/reset report 99
 - clerk secret number key 19, 28
 - clerk transfer 24, 82
 - closing a check 78
 - commercial message 26, 91
 - commission rate 90
 - condiment 84
 - consecutive No. 26
 - contrast control 20
 - correction 47
 - coupon 23, 57
 - coupon II (2) 24, 57
 - credit 23, 41
 - cube 24
 - currency exchange 22, 62
 - cursor key 95
 - customer display 20
 - customer number 24
- D**
- daily sales read/reset report 100
 - daily sales reset report 50
 - Dallas key 16
 - date display 29
 - date set 15
 - declaration 24
 - department 23, 30
 - deposit 24, 85
 - descriptor 91
 - discount (%-) 22, 38
 - display 20
 - double size letter key 95
 - drawer 19
- E**
- eat-in 24
 - EBT (electronic benefits transfer) 24, 71
 - editing character 97
 - entering characters 95
 - error code 110
 - error correction 22, 47
 - Euro 23, 42
- F**
- financial read report 99
 - flat PLU 24
 - food stamp 64
 - food stamp shift 24, 64
 - food stamp subtotal 24, 64
 - food stamp tender 24, 64
- G**
- group read/reset report 103
 - guest receipt 78
- H**
- high amount limitation 32
 - hourly sales read/reset report 102
- I**
- Illinois rule 67
 - indicator 21
 - individual clerk read/reset report 99
 - individual department, PLU/flat-PLU read report 98
 - item counter 21, 26
- J**
- journal 14, 26
 - journal paper replacement 114
 - journal skip 26

K

Ketten Bon 24
keyboard 16, 22

L

loan 24, 46
locking platen 13, 14
logo message 26, 91

M

machine No. 26
main display 16, 20
manual tax 24
media change 22, 46
menu shift 24
merchandise subtotal 24, 37
message 26, 91
minus 22, 39
mixed tender 41
mode key 17
mode keys 16
mode switch 18
money declaration 99, 101
monthly sales read/reset report 103
multiplication 23, 31, 35
multiplication/for 22, 31, 36

N

new balance 24, 77
new check 24, 76
new/old check 24, 76
no sale 22, 24
non add 22, 24
normal receipt 24
not found PLU 89
number of customers 73

O

OBR (optical barcode reader) 24
old check 24, 76
one touch NLU 24, 89
open 23
open 2 (release compulsion) 25, 74
open check 25
open PLU 36
opening a check 77
operator number 25, 82
operator X/Z 25
option 115

P

paid out 23, 45
paper feed 22
paper installation 12
paper loading 12
periodic sales 104
pick up 25, 46
platen 12
platen arm 12, 16
PLU 22, 34
PLU/flat-PLU read/reset report 102
plus 25
pop-up display 16
post receipt 22
power failure 113
premium (%+) 25, 55
preparation 84
preset price 33
preset tax status 33
preset tender 59
previous balance 25
previous balance subtotal 25
previous item void 88
price 23, 36
price change 25
price inquiry 25
price reductions (red price) 83
price shift 25
printer 12, 16
printer cover 16
printer cover key 16
printing slip 75
program end key 95

R

rate tax 25
read report 98
recall 25
receipt 13, 26
receipt on/off 22
receipt on/off switch / key 16
receipt paper replacement 115
received on account 23, 45
red price 25, 83
reduction 39
refund 22, 44
repeat 21, 30, 35
reset report 50, 98
return 44
review 25, 81, 88
RF mode 44
roll paper 16
roll paper installation 12

S

- scale 25
- scanning PLU 89
- second unit price 58
- separate check 25, 81
- set menu 61
- shift key 95
- sign off 28
- sign on 28
- single item 30, 35, 53
- slip 75
- slip back feed/release 25, 75
- slip feed/release 25, 75
- slip print 25, 75
- space key 95
- split sales of packaged item 31, 36
- square 25
- stock check 52
- stock inquiry 25, 87
- store 25
- subtotal 23

T

- table number 25, 77
- table transfer 25, 82
- take-up reel 16
- takeout 25
- tare 25
- tax exempt 25
- tax shift 23, 37
- taxable amount subtotal 25
- taxable status 37
- text print 25
- text recall 25, 74
- tilt LCD 20
- time display 29
- time set 15
- tip 25, 72
- trainee status 90
- tray total 25, 56

U

- unit price inquiry 87
- unit weight 25

V

- validation 25
- VAT 23, 85
- void 25

W

- wetproof cover 115

CASIO®

CASIO COMPUTER CO., LTD.
6-2, Hon-machi 1-chome
Shibuya-ku, Tokyo 151-8543, Japan

TE-3000*E

MO0305-A Printed in Malaysia

Printed on recycled paper.