

ELECTRONIC CASH REGISTER

PCR-365A

THANK YOU
YOUR RECEIPT
CALL AGAIN!

GROCERY
DAIRY
H.B.A.
FROZEN
FOOD
DELICATESSEN



OPERATOR'S INSTRUCTION MANUAL

Introduction & Contents

Unpacking the register

Welcome to the CASIO PCR-365A!

Congratulations upon your selection of a CASIO Electronic Cash Register, which is designed to provide years of reliable operation.

Operation of a CASIO cash register is simple enough to be mastered without special training. Everything you need to know is included in this manual, so keep it on hand for reference.

If you need programming assistance, please call 1-800-638-9228.

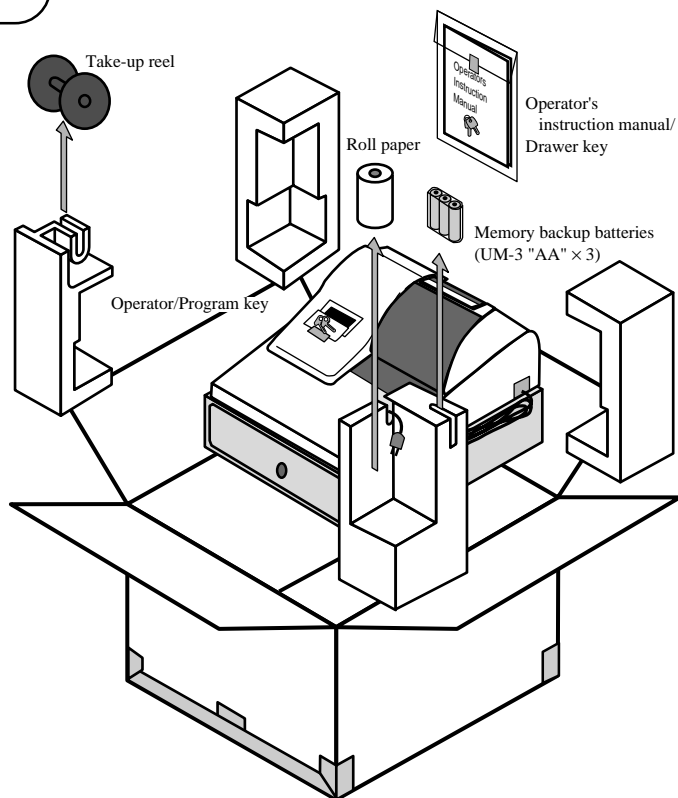

CASIO AUTHORIZED SERVICE CENTER

If your Casio product needs repair, or you wish to purchase replacement parts, please call 1-800-YO-CASIO for the authorized service center nearest your home.

If for any reason this product is to be returned to the store where purchased, it must be packed in the original carton/package.

GUIDELINES LAID DOWN BY FCC RULES FOR USE OF THE UNIT IN THE U.S.A. (Not applicable to other areas)

WARNING: This equipment has been tested and found to comply with the limits for a Class A digital device, pursuant to Part 15 of the FCC Rules. These limits are designed to provide reasonable protection against harmful interference when the equipment is operated in a commercial environment. This equipment generates, uses, and can radiate radio frequency energy and, if not installed and used in accordance with the instruction manual, may cause harmful interference to radio communications. Operation of this equipment in a residential area is likely to cause harmful interference in which case the user will be required to correct the interference at his own expense.

FCC WARNING: Changes or modifications not expressly approved by the party responsible for compliance could void the user's authority to operate the equipment.

The main plug on this equipment must be used to disconnect main power.
Please ensure that the socket outlet is installed near the equipment and shall be easily accessible.

Please keep all information for future reference.

Important!

Before you do anything, be sure to note the following important precautions!

Do not locate the cash register where it will be subjected to direct sunlight, high humidity, splashing with water or other liquids, or high temperature (such as near a heater).

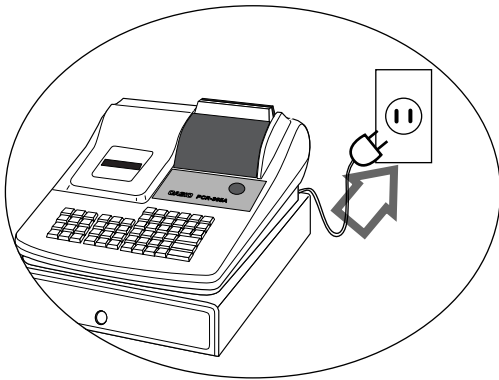
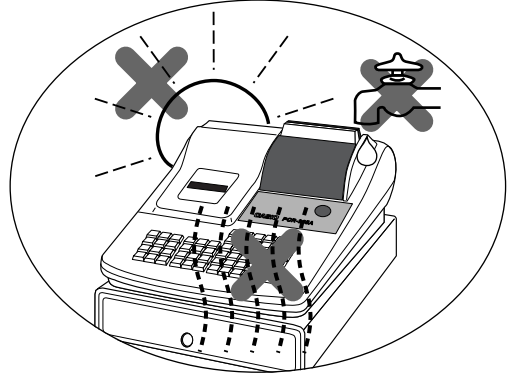

Be sure to check the sticker on the side of the cash register to make sure that its voltage matches that of the power supply in the area.

Never operate the cash register while your hands are wet.

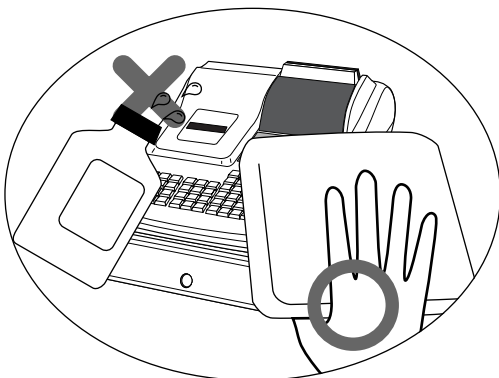

Use a soft, dry cloth to clean the exterior of the cash register. Never use benzene, thinner, or any other volatile agent.

Never try to open the cash register or attempt your own repairs. Take the cash register to your authorized CASIO dealer for repairs.

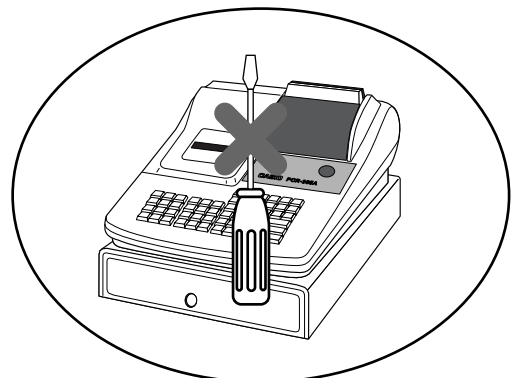

Introduction & Contents

Introduction & Contents	2
Unpacking the register	2
Getting Started	6
Remove the cash register from its box	6
Remove the tape holding parts of the cash register in place	6
Install the three memory backup batteries	6
Plug the cash register into a wall outlet	8
Insert the mode key marked "PGM" into the mode switch	8
Turn the mode key to the "REG" position	8
To set the ink ribbon	8
Install receipt/journal paper	9
To load 1-ply paper for printing of receipts	9
To load 1-ply paper for printing of journal	10
To load 2-ply paper for printing of receipts	11
Set the date	12
Set the time	12
Select printouts receipt or journal	12
Programming automatic tax calculation	13
Programming the U.S. tax table procedure	13
Introducing PCR-365A	18
General guide	18
Mode key, drawer, mode switch	18
Displays	20
Keyboard	22
Basic Operations and Setups	24
How to read the printouts	24
How to use your cash register	25
Displaying the time and date	26
Preparing coins for change	26
Preparing and using department keys	27
Registering department keys	27
Programming department keys	29
Registering department keys by programming data	30
Preparing and using PLUs	31
Programming PLUs	31
Registering PLUs	32
Preparing and using discounts	34
Programming discounts	34
Registering discounts	35
Preparing and using reductions	36
Programming for reductions	36
Registering reductions	37
Calculating the merchandise subtotal	38
Shifting taxable 1/2 status of an item	39
Registering charge and check payments	40

Registering returned goods in the REG mode	41
Registering returned goods in the RF mode	42
Registering money received on account	43
Registering money paid out	43
Making corrections in a registration	44
No sale registration	46
Printing the daily sales reset report	47
Convenient Operations and Setups	48
Clerk control function, Post-finalization receipt format, General printing control, Compulsory, Machine features	48
About the clerk control function	48
About post-finalization receipt	49
Programming general printing control	50
Programming compulsory and clerk control function	51
Programming read/reset report printing control	52
Setting a store/machine number	52
Programming to clerk	53
Programming descriptors and messages	54
Programming report descriptor, grand total, special character, report title, receipt message and clerk name	54
Programming department key descriptor	57
Programming PLU descriptor	58
Programming function key descriptor	59
Entering characters	60
Department key programming	62
PLU feature programming	64
Percent key feature programming	69
Currency exchange programming	72
Other function key programming	75
Calculator functions	76
Printing read/reset reports	78
Reading the cash register's program	84
Troubleshooting	88
When an error occurs	88
When the register does not operate at all	89
In case of power failure	90
When the L sign appears on the display	90
User Maintenance and Options	91
To replace the ink ribbon	91
To replace journal paper	92
To replace receipt paper	93
Specifications	94
Index	95

3. Install the three memory backup batteries. (continued...)



3. Note the (+) and (-) markings in the battery compartment. Load a set of three new SUM-3 ("AA") batteries so that their positive (+) and negative (-) ends are facing as indicated by the markings.



4. Replace the battery compartment cover.

5. Replace the inner cover and printer cover.

Important!

These batteries protected information stored in your cash register's memory when there is a power failure or when you unplug the cash register. Be sure to install these batteries.

Precaution!

Incorrectly using batteries can cause them to burst or leak, possibly damaging the interior of the cash register. Note the following.

- Be sure that the positive (+) and negative (-) ends of the batteries are facing as marked in the battery compartment when you load them into the unit.
- Never mix batteries of different types.
- Never mix old batteries with new ones.
- Never leave dead batteries in the battery compartment.
- Remove the batteries if you do not plan to use the cash register for long periods.
- Replace the batteries at least once every two years, no matter how much the cash register is used during the period.

WARNING!

- Never try to recharge the batteries supplied with the unit.
- Do not expose batteries to direct heat, let them become shorted or try to take them apart.

Keep batteries out of the reach of small children. If your child should swallow a battery, consult a physician immediately.

Getting Started

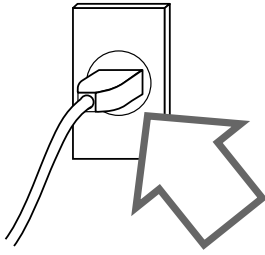

4. Plug the cash register into a wall outlet.

Be sure to check the sticker on the side of the cash register to make sure that its voltage matches that of the power supply in your area. The printer will operate for a few seconds.

5. Insert the mode key marked "PGM" into the mode switch.

About the mode key and mode switch, please refer to page-18, 19.

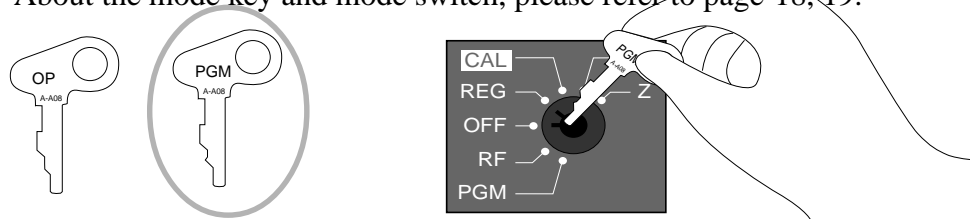

6. Turn the mode key to the "REG" position.

The display should change to the following.

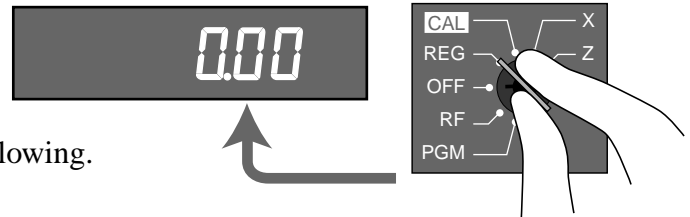

7. To set the ink ribbon



1

Remove the printer cover.

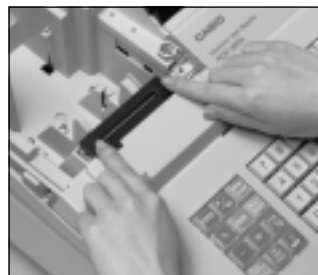

3

Load a new ink ribbon cassette into the unit.



2

Remove the inner cover.

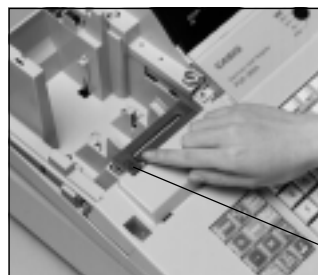

4

Turn the knob on the left side of the cassette to take up any slack in the ribbon.

Knob

8. Install receipt/journal paper.

Important!

Never operate the cash register without paper. It can damage the printer.

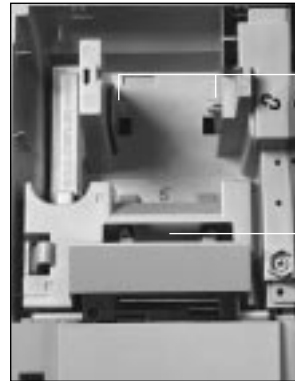

Roll paper spindle

Paper inlet

To load 1-ply paper for printing of receipts

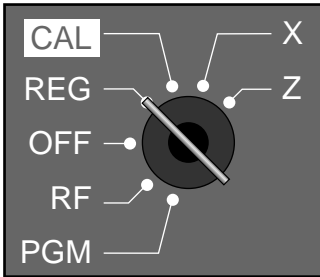

1 Use a mode key to set the mode switch to REG position.

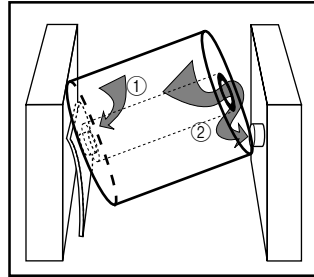

5 Work the paper roll gently between the two spindles so that they slip into the center hubs of the roll.



2 Remove the printer cover.



6 Insert paper to the paper inlet.



3 Cut off the leading end of the paper so it is even.



7 Press the **FEED** key until about 20 cm to 30 cm of paper is fed from the printer.



4 Ensuring the paper is being fed from the bottom of the roll, lower the roll into the space behind the printer.



8 Replace the printer cover, passing the leading end of the paper through the cutter slot. Tear off the excess paper.

8. Install receipt/journal paper. (continued...)

To load 1-ply paper for printing of journal

Follow steps **1** through **7** under "To load 1-ply paper for printing of receipts" on the previous page.



8

Remove the flat side plate of the take-up reel.



12

Press the **FEED** key to take up any slack in the paper.



9

Slide the leading end of the paper into the groove on the spindle of the take-up reel and wind it onto the reel two or three turns.



13

Replace the printer cover.



10

Replace the flat side plate of the take-up reel.



11

Place the take-up reel into place behind the printer, above the roll paper.

8. Install receipt/journal paper. (continued...)

To load 2-ply paper for printing of receipts

Follow steps **1** through **5** under "To load 1-ply paper for printing of receipts" above.



6 Separate the two sheets of the paper.



8 Press the **FEED** key until about 20 cm to 30 cm of paper is fed from the printer.



7 Join the ends of the paper again and insert them into the paper inlet.



9 Insert the leading end of the inner sheet (which will be your journal) into the take-up reel, as described starting from step **8** under "To load 1-ply paper for printing of journal."

10 Replace the printer cover, passing the leading end of the outer sheet through the cutter slot. Tear off the excess paper.

Getting Started

9. Set the date.

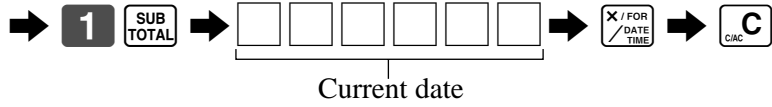
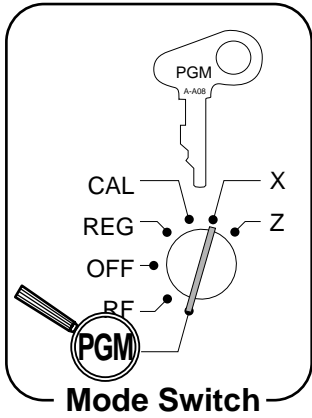

Example:

May 11, 2000 ⇒ **0 0 0 5 1 1**

10. Set the time.

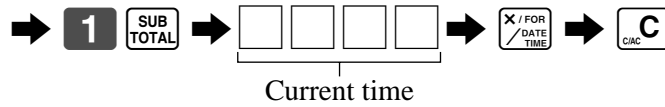
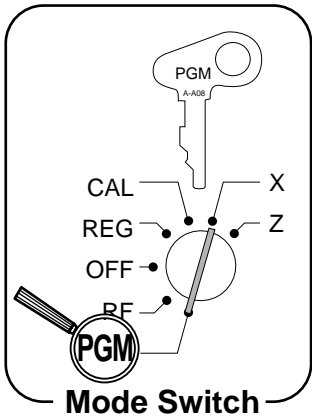

Example:

08:20 AM ⇒ **0 8 2 0**

09:45 PM ⇒ **2 1 4 5**

(24-hour military time format)

11. Select printouts receipt or journal.

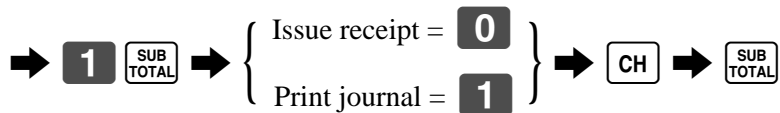
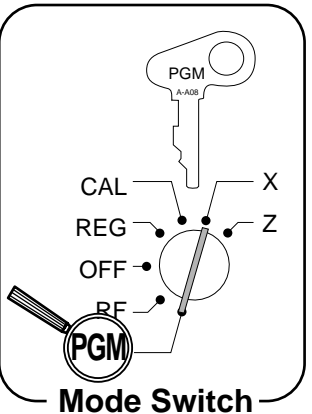

Note:

Be sure to select **0** (receipt) when you use 2-ply paper.

12. Tax table programming

Programming automatic tax calculation

Important!

After you program the tax calculations, you also have to individually specify which departments (page 29) and PLUs (page 31) are to be taxed.

For this cash register to be able to automatically register state sales tax, you must program its tax tables with tax calculation data from the tax table for your state. There are three tax tables that you can program for automatic calculation of three separate sales taxes.

Programming for the U.S. tax tables procedure

Find your state in the table (page 14 ~ 17) and input the data shown in the table.

State sales tax calculation data tables for all of the states that make up the United States are included on the following pages. This data is current as of October 30, 1994.*

*Some data are revised after Oct. 30, 1994.

Important!

Be sure you use the state sales tax data specifically for your state. Even if your state uses the same tax rate percentage as another state, inputting the wrong data will cause incorrect result.

Programming procedure

Example 1 (Alabama 6% sales tax to Tax Table 1) Example 2 (Colorado 5.25% sales tax to Tax Table 2)

ALABAMA						
4%	5%	6%	6%	6%	7%	8%
			(4+1+1)			
0	0	0	0	0	0	0
1	1	1	1	1	1	1
1	1	1	1	1	1	1
10	10	8	9	10	7	6
30	29	24	20	20	21	18
54	49	41	40	36	35	31
73	69	58	55	54	49	43
110	89	70	70	70	64	56
	110	90	85	78	68	68
		109	110	92	81	81
				107	93	93
					106	106

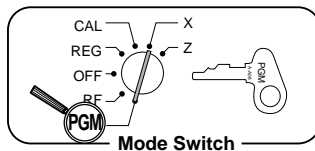

COLORADO					
4.5%	5%	5%	5.25%	5.5%	
LOVELAND					
0	211	0	0	5.25	0
1	233	1	1	5002	1
5	255	2	1		6
17	277	17	18		17
33	299	29	18		27
55		49	51		45
77			68		63
99			84		81
122			118		99
144					118
166					136
188					154

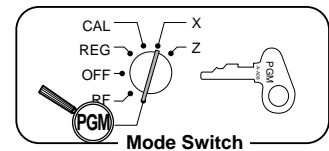

Assign Tax Table 1

- 0
- 1
- 1
- 8
- 24
- 41
- 58

Terminate program

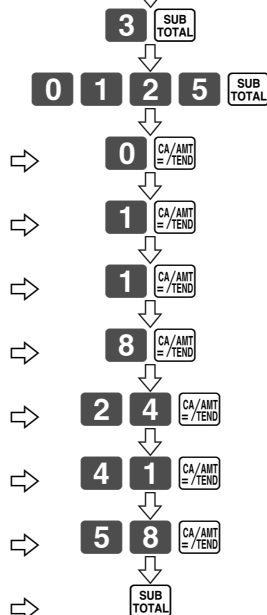

Assign Tax Table 2

- (Table 3: 0 3 2 5)
- 5.25
- 5002

Terminate program

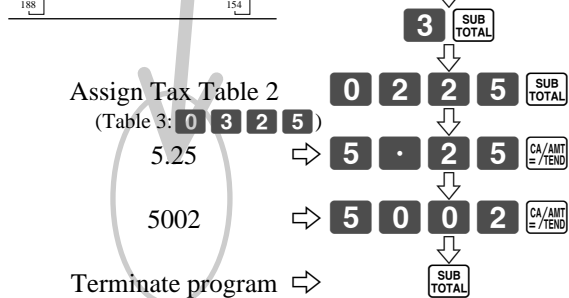

Getting Started

U.S. TAX TABLES

A

ALABAMA							
4%	5%	6%	6%	6% (4+1)	7%	8%	
0	0	0	0	0	0	0	0
1	1	1	1	1	1	1	1
1	1	1	1	1	1	1	1
10	10	8	9	10	7	6	6
30	29	24	20	20	21	18	18
54	49	41	40	36	35	31	31
73	69	58	55	54	49	43	43
110	89	70	70	64	56	56	56
	110		90	85	78	68	68
			109	110	92	81	81
					107	93	93
						106	106

ALASKA							
KENAI	HOMER/SELDOVIA	HAINES	JUNEAU	KENAI	KENAI & SOLDOTNA		
2%	3%	3%	4%	4%	5%	5%	
0	0	0	0	0	0	0	0
1	1	1	1	1	1	1	1
1	1	1	1	1	1	1	1
10	10	8	9	10	7	6	6
30	29	24	20	20	21	18	18
54	49	41	40	36	35	31	31
73	69	58	55	54	49	43	43
110	89	70	70	64	56	56	56
	110		90	85	78	68	68
			109	110	92	81	81
					107	93	93
						106	106

ALASKA			
HOMER	5.5%	6%	
0	145	345	6
1	163	363	2
1	181	381	29
8	208	408	29
27	227	49	239
45	245	69	259
63	263	89	259
81	281	109	279
99	299	109	300
108	308	129	
127	327	159	

ARIZONA											
4%	5%	6%	6.5%	6.7%	6.8%	7%					
0	0	0	175	0	161	0	156	0	153	345	0
1	1	1	191	1	176	1	171	1	168	359	1
1	5	9		7	192	7	186	3	183	374	1
12	10	10		7	207	7	201	6	198	389	7
37	27	22		23	223	22	216	21	212	403	21
	47	39		38	238	37	231	36	227	418	35
	68	56		53	253	52	246	50	242	433	49
	89	73		69	269	67	261	65	256	448	64
	109	90		84	284	82	276	80	271	452	78
		107		99	299	97	291	95	286	477	92
		125		115	311	111	309	300	300	492	107
		141		130	326	126	315	315	315	506	
		158		146	341	141	330	330	330		

ARKANSAS							
3%	4%	5%	6%	6.8%	7%	7.5%	
0	0	0	0	0	0	0	0
1	1	1	1	1	1	1	1
1	1	1	1	1	2	1	2
14	12	10	8	6	7	6	6
44	37	20	24	19	21	19	19
74	40	41	33	35	35	33	33
114	60	58	46	49	49	46	46
	80			64	64		
	110			78	78		
				92	92		
				107	107		

C

CALIFORNIA												LOS ANGELES				
6%	6.25%	6.5%	6.75%	7%	7.25%	7.25%	7.5%	7.75%	8.25%	8.5%	9%	10%	Parking			
0	141	0	130	299	6.75	0	121	278	7.25	117	7.25	0	7.75	8.25	0	99
1	158	1	146		5002	1	135	292	5002	131	5002	1	5002	5002	1	111
7	7	7	161		0	8	149	307	0	6	3	1	123	11	104	104
10	10	10	176		10	10	164	10	10	6	6	5	135	99	114	114
22	21	20	192		20	20	178	20	20	19	19	17	147	99	124	124
39	37	35	207		34	33	192	32	32	33	33	29	158	99	134	134
56	54	51	223		48	47	207	46	46	46	46	41	170	99	144	144
73	70	67	238		64	62	221	60	60	59	59	52	182	99	154	154
90	86	83	253		80	76	235	74	74	73	73	64	194	99		
108	103	99	269		96	91	249	88	88			76	205	99		
124	119	115	284		111	107	264	103	103			88		99		

COLORADO																			
LOVELAND																			
1.5%	2%	2.5%	3%	3.5%	3.6%	3.85%	4%	4.5%	5%	5%	5.25%	5.5%	5.6%	5.75%	6%	6.1%	6.35%	6.4%	
0	0	0	0	0	0	264	0	0	0	211	0	0	5.25	0	172	0	168	0	6.1
1	1	1	1	1	1	291	1	1	1	233	1	1	5002	1	190	1	186	1	5002
1	1	1	3	2	5	319	2	2	5	255	2	1	6	209	7	204	8	199	2
33	24	19	17	17	17	347	16	17	17	277	17	18	17	227	16	222	17	217	17
99	74	59	49	42	41	375	37	37	33	299	29	18	27	245	25	240	26	24	24
166			83	71	69		63	62	55		51	18	45	263	43	43	41	41	41
233			116	99	97			77	77		68	18	63	281	61	60	58	58	58
			149	128	124			99	99		84	18	81	299	79	78	74	74	74
			183	157	152			122	122		118	18	99	97	95	95			
			185	180	180			144	144				118	115	113	113			
			214	208	208			166	166				132	130	130	130			
			242	236	236			188	188				154	150	147	147			

COLORADO															
6.45%	6.5%	6.6%	7%	7.01%	7.1%	7.2%	7.25%	7.3%	7.5%	8%					
6.45	0	146	6.6	0	135	7.01	7.1	0	131	7.25	0	130	0	0	
5002	1	161	5002	1	149	5002	5002	1	145	5002	1	143	1	1	
0	2	176	4	4	0	2	159	3	157	3	1	171	17	6	
17	17	192	17	17	17	17	173	17	173	17	17	17	17	6	
	23	207	21	21	21	20	187	20	187	20	19	18	19	18	
	38	223	35	35	35	34	201	34	201	34	33	31	33	31	
	53		49	49	49	48	215	47	215	47	46	43	46	43	
	69		64	64	64	62	229	61	229	61	59	56	59	56	
	84		78	78	78	76	243	75	243	75	73	68	73	68	
	99		92	92	92	90	256	89	256	89	87	81	87	81	
	115		107	107	107	104		102		102	93	86	93	86	
	130		121	121	121	118		116		116	106	99	106	99	

CONNECTICUT					
5.25%	6%	7%	7.5%	8%	
0	198	0	0	0	0
1	218	1	1	1	1
2	2	2	1	3	1
16	8	7	6	6	6
27	24	21	19	18	18
46	41	35	33	31	31
65	58	49	46	46	46
84	74	64	59	59	59
103	91	78	73	73	73
122	108	92			
141	124	107			
160					
179					

D

DISTRICT OF COLUMBIA					
D.C. 5%	D.C. 5.75%	D.C. 6%	D.C. 6%	D.C. 8%	D.C. 9%
0	5.75	0	0	0	0
1	5002	1	1	1	1
1	0	1	1	1	6
10	8	12	8	12	6
22	17	24	16	16	149
42	35	41	27	27	161
82	53	58	39	38	
62	71	74	50	49	
110	89	91	62	61	
	112	108	75	72	
			90	83	
			112	94	

F

FLORIDA							
PANAMA CITY BEACH							
4%	5%	5.25%	6%	6.2%	7%	7.5%	
0	175	0	5.25	0	6.2	0	107
1	209	1	5002	1	5002	1	123
5	1	1	1	1	1	1	138
9	9	9	9	9	9	9	153
25	20	16	16	15	169	14	169
50	40	33	33	30	184	28	184
75	60	50	50	46	209	42	209
109	80	66	66	61	57	53	186
125	109	83	83	76	71	66	209
150		109		92	85	80	

G

GEORGIA			
3%	4%	5%	6%
0	0	0	0
1	1	1	1
1	1	1	1
10	10	10	10
35	25	20	20
66	50	40	35
110	75	60	50
	110	80	67
		110	85
			110

H

HAWAII	4%
0	0
1	1
1	1
10	10
35	20
66	50
110	80
	67
	37

IDAHO			
3%	4%	4.5%	5%
0	0	0	227
1	1	1	1
1	2	2	2
15	11	15	11
42	32	27	25
72	57	49	45
115	71	71	
	93		
	115		
	137		
	160		
	183		
	205		

ILLINOIS													
1%	1.25%	2%	5%	6%	6.25%	6.5%	6.75%	7%	7.5%	7.75%	8%	8.75%	
0	0	0	0	0	0	0	161	6.75	0	0	7.75	0	8.75
1	1	1	1	1	1	1	176	5002	1	1	5002	1	5002
1	1	1	1	6	1	1	192	1	1	0	1	0	0
49	39	24	12	8	7	7	207	8	6	6	6	5	
148	119	74	25	24	23	23		22	19	18	18		
			46	41				36	33		31		
			67	58				50	46				
			88					65					
			109					79					
			129					93					
								115	108				
								130					
								146					

INDIANA				
1%	4%	5%	MARION County	RESTAURANT
			5%	6%
0	0	0	0	0
1	1	1	1	1
1	2	1	2	1
49	15	9	15	9
148	37	29	37	29
			49	49
			62	49
			87	69
			112	89
			137	109

IOWA		
4%	5%	6%
0	0	0
1	1	1
3	1	1
12	9	8
37	29	24
50	41	
75	58	
	74	
	91	
	108	

KANSAS															
2.5%	3%	3.1%	3.25%	3.5%	3.75%	4%	4.1%	4.5%	4.9%	5%	5.25%	5.4%	5.5%	5.65%	
0	0	3.1	0	323	0	0	279	0	4.1	0	0	214	479	744	1010
1	1	5002	1	353	1	1	306	1	5002	1	1	234	499	765	
3	1	0	1	384	1	1	333	1	0	1	1	255	520	785	
12	9	8	19	16	16	15	415	14	13	359	12	11	10	275	540
37	29	24	59	49	46	42	39	386	37	33	30	295	561	826	
50	41		99	83	76	71	66	51	316	55	51	316	581	846	
75	58		139	116	107	99	93	87	77	71	336	602	867		
	74		179		138	128	119	112	99	91	357	622	887		
					169	157	146		122	112	377	642	908		
					199	185	173		144	132	397	663	928		
					230		199		166	153	418	683	948		
					261		226		188	173	438	704	969		
					292		253		211	193	459	724	989		

KANSAS					
5.9%	6%	6.15%	6.4%	6.5%	10%
5.9	0	6.15	6.4	6.5	0
5002	1	5002	5002	5002	1
0	7	0	0	0	1
8	8	8	7	7	5
	24		15	152	4
	41		26	163	24
	58		36	173	34
	74		47	184	44
	91		57	194	54
	108		68	64	64
	124		78	74	74
	141		89	84	84
	158		99	94	94

KENTUCKY	
5%	6%
0	0
1	1
6	2
10	8
25	24
46	41
67	58
88	74
109	
129	

LOUISIANA										
2%	3%	4%	4.5%	5%	6%	7%	7.5%	8%	9%	
0	0	0	0	0	0	0	161	0	0	0
1	1	1	1	1	1	1	176	1	1	1
2	2	2	2	1	6	2	17	1	2	7
24	16	12	11	10	8	7	207	7	6	4
74	49	37	33	27	24	23	223	21	19	16
124	82	62	55	47	41	38	238	35	33	29
174	116	87	77	67	58	53	253	49	46	42
224	149	112	99	87	74	69	269	64	59	55
			122	109	84	84	284	67	61	67
			144	129	99	99	299	80	72	72
			166	166	115	115	315	93	83	83
			188	188	130	130	330	106	94	94
			211	211	146	146		105		105

MAINE		
5%	6%	7%
0	0	7
1	1	2
1	1	0
10	9	7
20	16	21
40	33	35
60	50	49
80	66	64
110	83	78
	109	92
		100

MARYLAND		
4%	5%	Meals Tax
		5%
0	0	0
1	1	1
2	2	7
24	19	99
25	20	99
50	40	99
		99
		99
		118
		140
		120
		140

MASSACHUSETTS		
4.625%	5%	
0	227	0
1	248	1
13	270	1
10	291	9
32	313	29
54	335	
75	356	
97	378	
118	399	
140	421	
162	443	
183		
205		

MICHIGAN	
4%	6%
0	0
1	1
7	2
12	10
31	24
54	41
81	58
108	74
135	91
162	108
187	124

MINNESOTA				
6%	6.5%	7%	8.5%	
0	0	161	0	123
1	1	176	1	135
1	1	192	1	147
8	7	207	7	158
24	23	21	17	170
41	38	35	29	182
58	53	49	41	194
	69	64	52	205
	84	78	64	
	99	92	76	
	115	107	88	
	130		99	
	146		111	

MISSISSIPPI										
5%	6%	7%	7.25%	8%	8.5%	9%	9.25%			
0	0	0	0	144	324	0	0	123	0	9.25
1	1	1	1	158	337	1	1	135	1	5002
6	1	1	1	172	351	1	1	147	1	0
11	8	7	6	186	365	6	5	158	5	5
26	24	21	20	199	379	18	17	170	16	
47	41	35	34	213	393	31	29	182	27	
68	58	49	48	227	406	43	41	194	38	
88	74	64	62	241	424	56	52	205	49	
109	91	78	75	255	441	68	64	61	61	
129	108	92	89	268	468	81	76	72	72	
			107	282	493	93	88	83	83	
				296	516	106	99	94	94	
				310	541	111		105		

MISSOURI																	
4.225%	4.6%	4.625%	4.725%	4.75%	4.8%	4.975%	5.05%	5.1%	5.225%	5.6%	5.625%	5.725%	5.975%	6.1%	6.225%	6.3%	6.425%
0	0	0	227	0	0	0	0	211	0	0	5.225	0	187	0	5.725	0	163
1	1	1	248	1	1	1	1	1	1	1	5002	1	205	1	5002	1	178
1	1	13	270	4	3	3	5	1	15	223	1	1	2	209	1	1	194
11	10	10	291	10	10	10	9	9	8	241	8	8	8	225	8	7	210
35	32	32	313	31	22	31	19	29	26	258	26	25	242	24	24	23	225
59	54	54	335	52	43	52	39	49	44	276	44	41	259	40	40	39	241
82	76	75	356	74	65	72	59	68	62	294	62	58	276	57	56	265	256
	97	97	378	95	86	93	79	88	80	312	79	75	292	73	72	71	272
		118	399	116	107	114	98	107	98	330	97	92	309	90	88	87	287
		140	421	137	128	135	118		115	348	115	108	326	104	103	101	
		162	443	158	149	156	138		133	366	133	125	342	120	119	116	
		183		179	170	177	158		151	383	151	142	359	136	134	132	
		205		201			178		169		168	158	376	152	150	147	

MISSOURI					
6.475%	6.55%	6.725%	7.225%		
0	162	0	160	6.725	7.225
1	177	1	175	5002	5002
13	193	9	190		
7	208	7			
23	223	22			
38	239	38			
54	254	53			
69	270	68			
84	285	83			
100	301	99			
115	316	114			
131	332	129			
146		145			

NEBRASKA							
3%	3.5%	4%	4.5%	5%	5.5%	6%	6.5%

Getting Started

N

NEW HAMPSHIRE			
Rooms & Meals		Rooms & Meals	
7%	7%	8%	8%
0	129	0	128
1	143	1	142
8	158	8	157
14	172	35	171
26	186	35	185
39	201	38	200
51		50	37
63		62	50
75		74	62
88		87	
101		100	
115		114	

NEW JERSEY			
3%	3.5%	6%	7%
0	0	0	0
1	1	1	1
1	1	1	8
17	14	10	10
41	42	22	21
71	71	38	35
117	100	56	50
	128	72	64
	157	88	78
	185	110	92
			107
			121
			135

NEW MEXICO									
3.75%	4.25%	4.375%	4.5%	4.875%	5.175%	5.25%	5.375%	5.575%	5.75%
0	280	0	247	0	239	0	4.875	5.175	0
1	306	1	270	1	1	1	5002	5002	1
6	333	1	294	4	1	1			11
13	359	11	317	11	11	11			9
40		35	341	34	33	33			28
67		58	364	57	55	55			47
93		82	388	79	78	78			66
120		105	411	102	100	100			85
146		129		125	122	122			104
173		152		148	144	144			123
200		176		171	167	167			142
226		199		194	189	189			161
253		223		217	211	211			180

NEW MEXICO	
6.187%	6.1875%
0	6.1875
1	5002
4	0
9	8
23	
40	
56	
72	
88	
104	
120	
136	
153	

NEW YORK													
4%	5%	5.25%	5.75%	6%	6.25%	6.5%	6.75%	7%	7.25%	7.5%	8%	8.25%	8.5%
0	0	5.25	5.75	0	141	0	0	130	6.75	0	121	7.25	0
1	1	5002	5002	1	158	1	1	146	5002	1	135	5002	1
7	7			7	7	1	1	161		8	149		8
10	10			10	10	7	7	176		10	164		10
22	22	23	23	192	20	178	18	17	17	17	17	17	17
38	38	38	38	207	33	192	31	33	192	31	29	29	29
56	54	53	53		47	207	45	45	45	42	42	42	42
72	70	69	69		62		58	55	58	55	54	54	54
88	86	84	84		76		71	67	71	67	67	67	67
108	103	99	99		91		85	80	91	85	80	79	79
124	119	115	115		107		99	92	107	99	92	92	92

SUFFOLK County				
8%	8.25%	8.5%	8.25%	8.5%
0	106	8.25	8.5	
1	118	5002	5002	
9	131			
10	144			
17	17			
29	29			
42	42			
54	54			
67	67			
79	79			
92	92			

NORTH CAROLINA					
CHROKKEE Reservations			6%		
3%	4%	4.5%	5%	6%	6%
0	0	0	188	0	0
1	1	1	211	1	1
4	5	6	233	6	2
9	9	9	255	8	10
35	29	25	277	23	24
70	59	53	299	48	41
116	84	75	322	67	58
149	112	95		85	74
183	137	122		109	91
216		144		129	108
		166			124

NORTH DAKOTA									
3%	4%	4%	5%	5.5%	6%	6.5%	7%	8%	
0	0	0	0	0	182	0	0	170	0
1	1	1	1	1	200	1	1	185	1
3	5	2	2	2	219	3	2	200	2
15	15	15	15	15	15	15	15	15	15
33	31	25	20	19	17	31	231	15	15
67	51	50	40	37	34	47	29	25	25
100	71	75	55	50	50	62	43	38	38
133	100	100	73	67	77	77	58	50	50
166	125	125	91	84	93	93	72	63	63
200			110	108	108	86	75	75	75
			128	124	124	100	88	88	88
			146	139	139	115	100	100	100
			164	154	154				

OHIO						
MEIGS Co.						6.25%
5%	5.5%	5.75%	6%	6%	6%	6.25%
0	0	146	5.75	0	0	0
1	1	164	5002	1	1	1
2	2	182		2	3	3
15	15	200		15	16	15
20	18	218		17	17	16
40	36			34	34	32
	54			50	50	
	72			67	67	
	90			83	83	
	109			100	100	
	127			117	117	

OHIO				
CUYAHOGA Co.				
6.5%	7%	7%	7.75%	
0	123	0	115	0
1	138	1	128	5002
3	153	3		
15	169	15		
15	184	15		
30	200	28		
46	215	42		
61	230	57		
76		71		
92		85		
107		100		

OKLAHOMA																		
2%	3%	3.25%	4%	4.25%	4.5%	5%	5.25%	6%	6.25%	6.25%	7%	7.25%	7.375%	8%	8.25%	9.25%	10.25%	
0	0	0	323	0	4.25	0	0	5.25	0	0	6.75	0	7.25	7.375	0	0	0	0
1	1	1	353	1	5002	1	1	5002	1	1	5002	1	5002	5002	1	1	1	1
1	1	7	384	1		2	1		1	1		6			0	1	4	1
24	16	15	415	12		11	9		8	7		8		6	6	6	5	4
74	49	46	446	37		33	29		24	23		22		18	18	16	14	14
	83	76	476			55			41			37		31	30	27	24	24
	116	107	507			77			58			51		42	37	34	34	34
		138	538			99						65		54	48	48	43	43
		169	569			121						79		66	59			
		199	599			144						94		78	70			
		230										108		90	81			
		261										122		103	91			
		292																

PENNSYLVANIA			
6%	7%	7%	7.75%
0	0	150	
1	1	150	
1	5	167	
10	10	184	
17	17	210	
34	34	217	
50	50	234	
67	50	250	
84	67	250	
110	84		
	110		
	117		
	134		

RHODE ISLAND			
6%	7%	7%	7.75%
0	0	149	
1	1	164	
6	5	178	
9	7	192	
26	21	207	
42	35	221	
57	49	235	
73	64	249	
90	78	264	
106	92		
123	107		
140	121		
	135		

SOUTH CAROLINA			
CHARLESTON			
4%	5%	6%	
0	0	0	
1	1	1	
5	6	2	
10	10	10	
25	20	24	
50	40	41	
75	60	41	
112	80	58	
137	109	74	
	129	91	
		108	
		124	

SOUTH DAKOTA						
4%	5%	5.5%	6%	6.5%	7%	
0	0	0	190	0	0	161
1	1	1	210	1	1	176
1	1	1		1	1	192
12	10	10		9	7	207
37	30			26	23	21
				46	38	35
				64	53	49
				82	69	64
				100	84	78
				118	109	99
				136		115
				154		130
				172		146

TENNESSEE														
COUNTY TAX														
4.5%	5.5%	6%	6.25%	6.5%	6.75%	7%	7.25%	7.5%	7.75%	8%	8%	8.25%	8.5%	8.75%
0	188	0	154	354	0	0	130	0	125	0	117	0	7.75	0
1	211	1	172	372	1	1	146	1	140	1	130	1	5002	1
1		11	190	390	2	2	161	8	155	2	10	144	2	2
11		10	209		10	10	176	10	170	10	10	158	10	10
33		27	227		24	23	192	22	185	21	20	172	19	18
55		45	245		41	39	207	37	199	35	34	185	33	31
77		63	263		58	55	223	51	214	49	48		46	43
99		81	281		74	71	69	66	229	64	61		59	56
122		99	299		87	84		81	244	78	75		75	68
144		119	318			99		96	259	92	89		89	8

TEXAS																			
															HOUSTON (Harris County)				
4%	4%	4.125%	4.625%	5%	5.125%	5.25%	5.375%	5.5%	5.625%	6%	DALLAS 6%	6%	6.125%	6.25%	6.25%	6.75%			
0	0	0	206	4.625	0	5.125	0	161	5.375	0	155	0	151	0	0	0	125	288	
1	1	1	230	5002	1	5002	1	180	5002	1	173	1	168	1	1	5002	1	140	303
1	1	1	254		1		12	199		1	191	1	1	1	1		3	155	318
12	12	12	278		9		9	219		9	209	8		8	7		8	170	333
37	37	36	303		29		28	238		27	26	24	25	24	23		22	185	348
	62	60	327		49		47			45	44	41	42	41	39		37	199	362
	87	84	351		69		66			63	62	58	59	58	55		51	215	377
		109	375				85			81	79	74		74	71		66	229	392
		133	399				104			99	97	91		91	87		81	244	407
		157	424				123			118	115	108		103	103		96	259	422
		181					142			137	133			119			111	274	437

TEXAS							
7%	7.25%	7.5%	7.75%	8%	8.25%		
0	107	7.25	0	96	0	8.25	
1		5002	1	1	109	1	5002
1			1	5	122	1	
7			6	6	135	6	
21			19	19	148	18	
35			33	32	161	31	
49			46	45	174		
64			59	58	187		
78			73	70			
92			86	83			

UTAH														
4.75%	5%	5.25%	5.375%	5.5%	5.75%	5.875%	6%	6.125%	6.25%	7%	7.25%			
0	221	0	0	199	0	0	190	5.75	5.875	0	6.125	0	0	7.25
1	242	1	1	219	1	1	209	5002	5002	1	5002	1	1	5002
1	263	1	1	238	1	1				0	2	0	4	2
10	284	9	9	257	9	9				8	8	8	7	7
31	305	29	28	276	27	27						24	23	21
52	326		47	295	46	45						41	27	35
73	347		66	314	65	63						58	47	49
94	368		85	333	83	81						74	63	64
115	389		104	352	102	99								78
136	410		123	371		118								92
157			142	390		136								107
178			161	409		154								
199			180			172								

VERMONT				
3%	4%	5%	8%	
0	0	0	0	
1	1	1	1	
4	2	2	0	
13	10	10	18	
33	25	20	31	
66	50	40	43	
100		80	56	
133		100	68	
166		120	81	
200		140	93	
			100	

VIRGINIA																					
ARLINGTON COUNTY				FAIRFAX		FAIRFAX CITY Meals tax		HAMPTON Restaurant		LEESBURG Meal tax		RICHMOND Restaurant		ALEXANDRIA		NEWPORT NEWS		RICHMOND		Restaurant	
4%				4.5%		6.5%		7%		7%		7.5%		7.5%		7.5%		7.5%		8%	
0	214	484	0	0	188	0	149	0	124	0	114	284	0	0	7.5	0	116	0	0	114	
1	234	512	1	1	211	1	166	1	144	1	134		1	1	5002	1	122	1	1	114	
1	259	537	2	5	233	4	188	1	166	13	149		1	1		1	144	2	5	134	
13	284		12	15	255	11	211	11	174	14	159		7	14		11	149	6	14	134	
33	314		37	33	277	14	233	24	188	29	184		21	14		16	166	19	34	159	
66	334		62	55	299	33	249	33	211	34	184		35	34		33	183	33	44		
100	359		87	77		55	255	55		44	214		49	59		49	188	46	44		
133	384		112	99		77	74	74		59	214		64	59		55	211	59	59		
166	414		137	122		99	77	74		74	234		78	84		77			59		
200	434		144	122		99	99	84		84	249		92	84		83			84		
	459		166	144		144	122	114		114	259		107	114		99			84		

VIRGINIA											
ROANOKE CITY VA BEACH		NORFOLK CITY			CITY OF RICHMOND						
8.5%		9%			9.5%						
0	99	9	0	99	211	0	89	205	0	89	209
1	112	5002	1	99	233	1	99		1	99	
1	122		6	122	233	1	110		1	109	
11	137		11	122		5	121		9	122	
12	144		33	144		15	131		11	129	
33	162		44	144		26	142		29	144	
37	166		44	166		36	152		33	149	
55	187		55	166		47	163		49	166	
62	188		55	188		57	173		55	169	
77	211		77	188		68	184		69	188	
87			77	211		78	194		77	189	

WASHINGTON																			
7%	7.2%	7.3%	7.5%	7.55%	4.125%	7.8%	7.9%	8%	8.1%	Combined		8.2%	8.7%						
										8.1%									
0	0	131	0	129	0	0	124	282	7.8	0	0	0	117	8.1	0	115	262	408	0
1	1		1	143	1	1	138		2	1	1	1	129	2	1	128	274	420	1
1	1		1	156	1	1	151		0	2	1	14	141	0	1	140	286	432	1
7	6		6	170	6	6	164		7	6	6	6	154	6	6	152	296	445	5
21	20		19	184	19	19	177		19	18	18	18	166	18	18	164	310	457	17
35	34		33	198	33	32	190		32	31	31	30	179	30	30	176	323	469	28
49	48		47	211	46	46	203		44	44		43	191	43	42	189	335	481	
64	62		61	225	59	59	217		57	56		55	203	55	54	201	347	493	
78	76		74	239	73	72	230		70			67		67	67	213	359	506	
92	90		88	252	86	85	243		83			80		80	79	225	371		
107	104		102		99	98	256					92			91	237	384		
	118		115		113	111	269					104			103	249	396		

WEST VIRGINIA				
2%	3%	4%	5%	6%
0	0	0	0	0
1	1	1	1	1
2	2	1	2	2
25	5	12	5	5
50	35	37	20	16
100	70		40	33
	100			50
	135			67
				84
				100
				116

WISCONSIN				
4%	5%	5.5%	5.6%	
0	0	0	190	0
1	1	1	209	1
1	1	1		1
12	10	9		8
37	21	27		26
	41	45		44
	61	63		62
	81	81		80
	110	99		98
		118		116
		136		133
		154		
		172		

WYOMING			
3%	4%	5%	6%
0	0	0	0
1	1	1	1
2	2	2	3
24	24	24	24
49	37	29	24
83	62	49	34
116		69	51
149		89	68
		109	84

Introducing PCR-365A

General guide

This part of the manual introduces you to the cash register and provides a general explanation of its various parts.

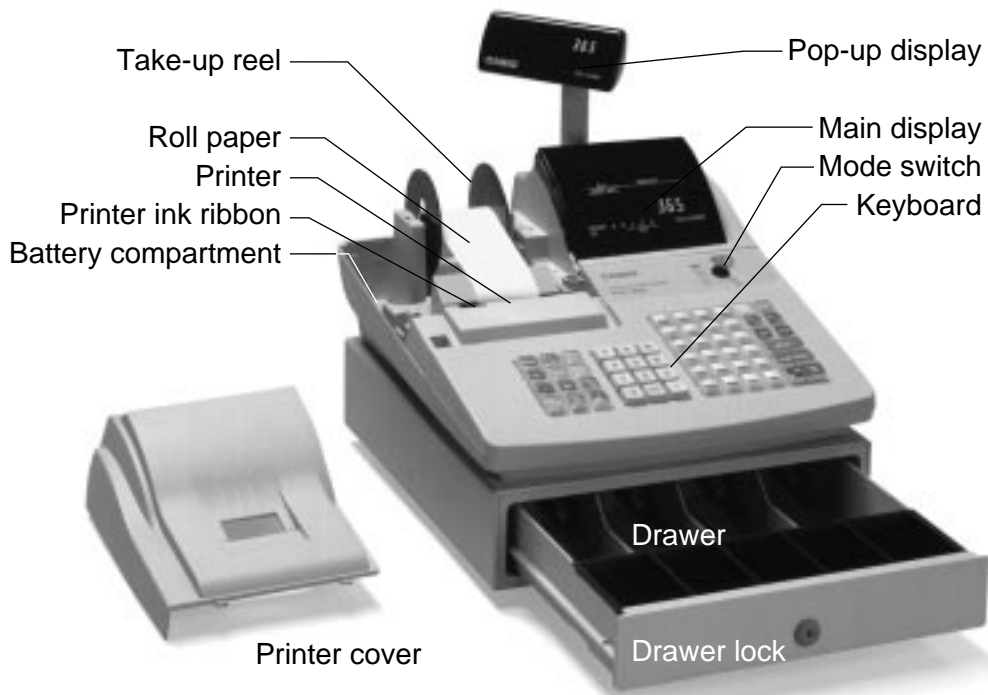

Battery compartment

Holds memory backup batteries (page 8).

Roll paper

You can use the roll paper to print receipts and a journal (page 9 ~ 11).

Printer ink ribbon

Provides ink for printing of registration details on the roll paper (page 6, 91).

Receipt on/off key

When you are using the printer for receipt printer, you can use this key (in the REG and RF modes only) to turn the printer on and off. If a customer asks for a receipt while receipt printing is turned off by this key, you can issue a post-finalization receipt (page 49).

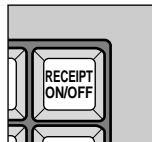

Note: Instead of the receipt on/off switch, receipt issuance is controlled by this key.

Mode key

There are two types of mode keys: the program key (marked "PGM") and the operator key (marked "OP"). The program key can be used to set the mode switch to any position, while the operator key can select the REG, CAL and OFF position

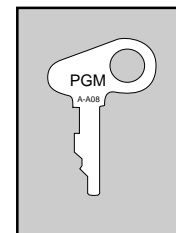

Program key

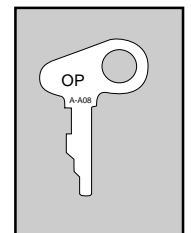

Operator key

Mode switch

Use the mode keys to change the position of the mode switch and select the mode you want to use.

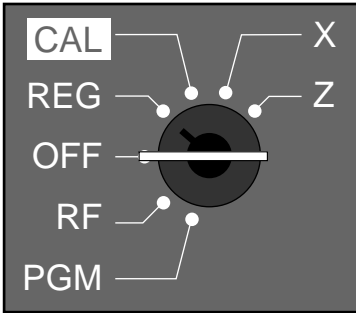

Mode Switch	Mode Name	Description
Z	RESET	Reads sales data in memory and clears the data.
X	READ	Reads sales data in memory without clearing the data.
CAL	CALCULATOR	Use this mode for calculator.
REG	REGISTER	Use this mode for normal registration.
OFF	STAND-BY	Cash register standing by.
RF	REFUND	Use this mode to register refund transaction.
PGM	PROGRAM	Use this mode for cash register programming.

Drawer

The drawer opens automatically whenever you finalize a registration and whenever you issue a read or reset report. The drawer will not open if it is locked with the drawer key.

Drawer lock

Use the drawer key to lock and unlock the drawer.

When the cash drawer does not open!

In case of power failure or the machine is in malfunction, the cash drawer does not open automatically. Even in these cases, you can open the cash drawer by pulling drawer release lever (see below).

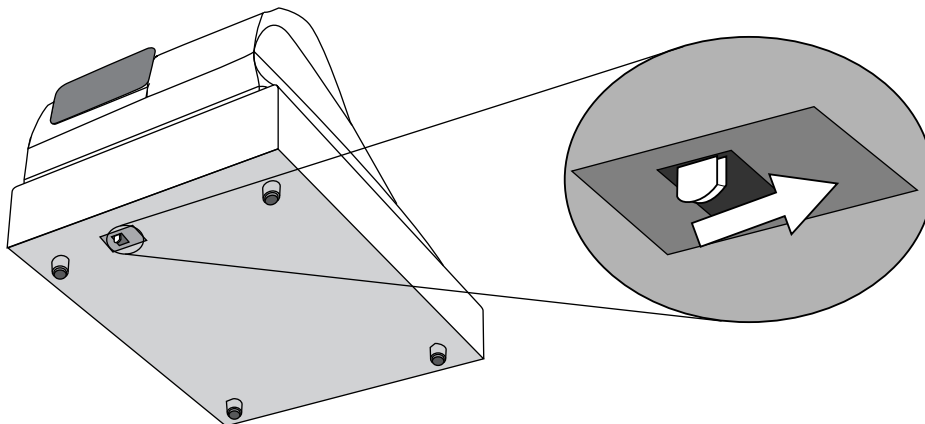

Important!

The drawer will not open, if it is locked with a drawer lock key.

Introducing PCR-365A

Displays

Main Display

Pop-up display

Department registration

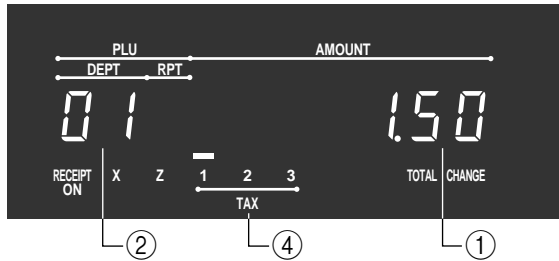

PLU registration

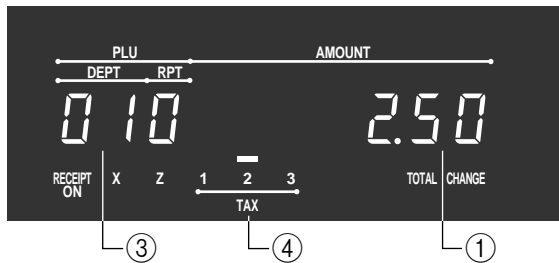

Repeat registration

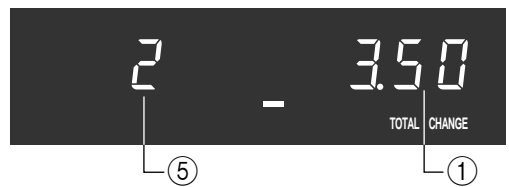
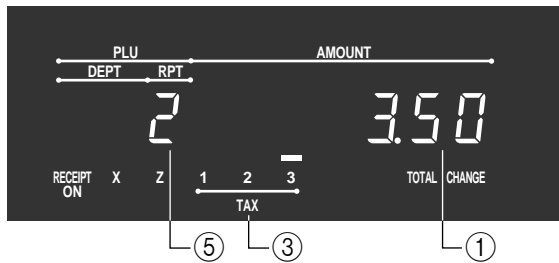

Totalize operation

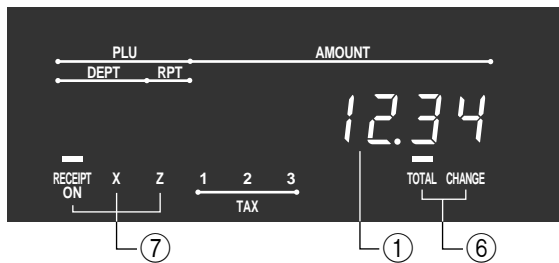

① **Amount/Quantity**

This part of the display shows monetary amounts. It also can be used to show the current date and time.

② **Department number**

When you press a department key to register a unit price, the corresponding department number (01 ~ 96) appears here.

③ **PLU (Subdepartment number)**

When you register a PLU (subdepartment) item, the corresponding PLU (subdepartment) number (001 ~ 600) appears here.

④ **Taxable sales status indicators**

When you register a taxable item, the corresponding indicator is lit.

⑤ **Number of repeats**

Anytime you perform a repeat registration (page 28, 32), the number of repeats appears here.

Note that only one digit is displayed for the number of repeats. This means that a "5" could mean 5, 15 or even 25 repeats.

⑥ **Total/Change indicators**

When the TOTAL indicator is lit, the displayed value is monetary total or subtotal amount. When the CHANGE indicator is lit, the displayed value is the change due.

⑦ **Receipt ON/OFF, X, Z indicators**

Receipt ON/OFF: When the register issues receipts, this indicator is lit. (REG/RF mode only)

X: Indicates X mode

Z: Indicates Z mode

Introducing PCR-365A

Keyboard

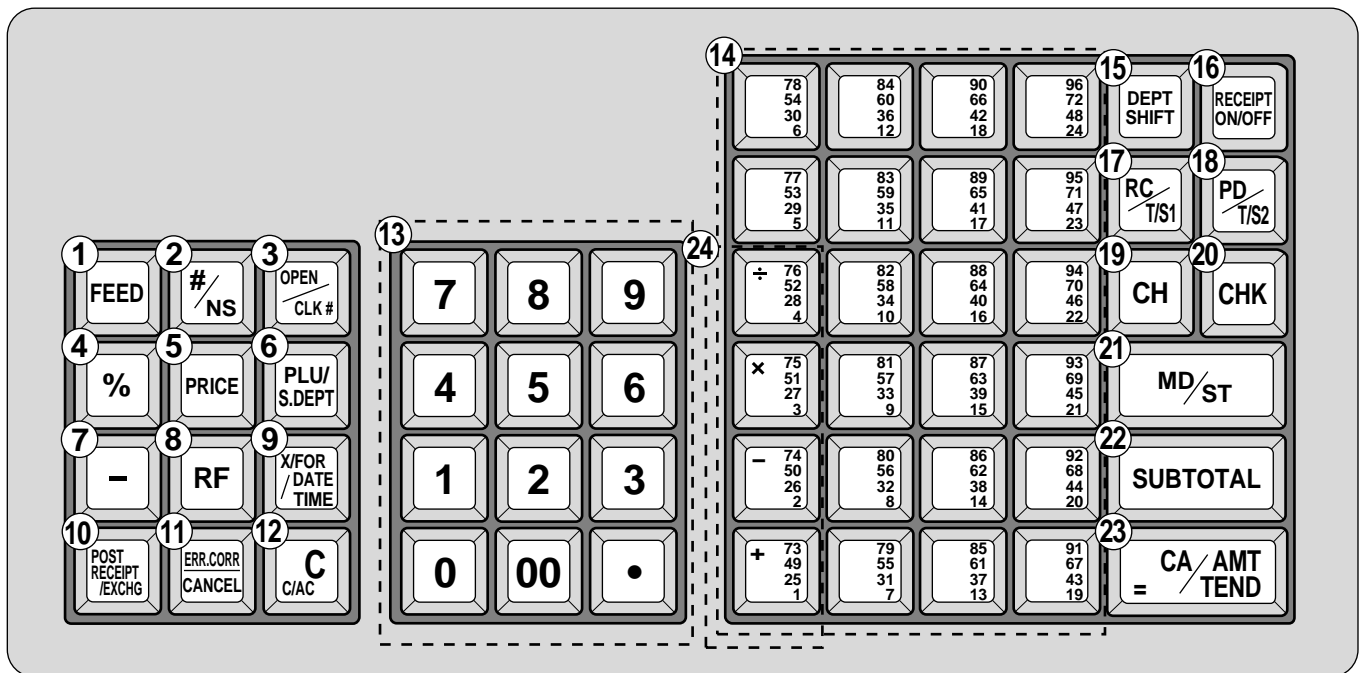



• Register Mode

- 1 Paper feed key** 

Hold this key down to feed paper from the printer.
- 2 Non-add/No sale key** 

Non-add key: To print reference number (to identify a personal check, credit card, etc.) during a transaction, press this key after some numerical entries.
No sale key: Press this key to open the drawer without registering anything.
- 3 Open/Clerk number key** 

It is necessary to select one of these functions (page 51).
Open key: Press this key to temporarily release a limitation on the number of digits that can be input for a unit price.
Clerk number key: Use this key to sign clerk on and off the register.
- 4 Percent key** 

Use this key to register premiums, discounts or manual tax.
- 5 Price key** 

Use this key to register unit prices for subdepartment.
- 6 PLU/Subdepartment key** 

Use this key to input PLU (subdepartment) numbers.
- 7 Minus key** 

Use this key to input values for subtraction.
- 8 Refund key** 



Use this key to input refund amounts and void certain entries.
- 9 Multiplication/For/Date/Time key** 

Use this key to input a quantity for a multiplication operation and registration of split sales of packaged items. Between transactions, this key displays the current time and date.
- 10 Post receipt/Currency exchange key** 

Post receipt key: Press this key to produce a post-finalization receipt (page 49).
Currency Exchange key: Use this key for calculating subtotal amounts or paying amount due in foreign currency (page 72).
- 11 Error correct/Cancel key** 

Use this key to correct registration errors and to cancel registration of entire transactions.
- 12 Clear key** 

Use this key to clear an entry that has not yet been registered.
- 13 Ten key pad** **0**, **1**, ~ **9**, **00**, **.**

Use these keys to input numbers.
- 14 Department keys**  ,  , ~ 

Use these keys to register items to departments.

About tax shift 3, refer to page 39.

15 Department shift key DEPT
SHIFT

Press this key to shift the department key number from 1 through 24 to 25 through 48, 49 to 72, 73 to 96 as follows.

- | | |
|--|---|
| 49/73
+ 1 ⇒ Dept.1 | DEPT
SHIFT DEPT
SHIFT 49/73
+ 1 ⇒ Dept.49 |
| 50/74
- 2 ⇒ Dept.2 | DEPT
SHIFT DEPT
SHIFT 50/74
- 2 ⇒ Dept.50 |
| : | : |
| 72/96
24 ⇒ Dept.24 | DEPT
SHIFT DEPT
SHIFT 72/96
24 ⇒ Dept.72 |
| DEPT
SHIFT 49/73
+ 1 ⇒ Dept.25 | DEPT
SHIFT DEPT
SHIFT 49/73
+ 1 ⇒ Dept.73 |
| DEPT
SHIFT 50/74
- 2 ⇒ Dept.26 | DEPT
SHIFT DEPT
SHIFT 50/74
- 2 ⇒ Dept.74 |
| : | : |
| DEPT
SHIFT 72/96
24 ⇒ Dept.48 | DEPT
SHIFT DEPT
SHIFT DEPT
SHIFT 72/96
24 ⇒ Dept.96 |

16 Receipt on/off key RECEIPT
ON/OFF

Press this key twice to change the status "receipt issue" or "no receipt." This key is only effective when the "use printer for receipt printer" in the printer control program is selected. In case of "receipt issue", the "RECEIPT ON" indicator is lit.

17 Received on account/Tax status shift 1 key RC/
T/S1

Received on account: Press this key following a numeric entry to register money received for non-sale transactions.
Tax shift 1: Press this key without numeric entry to change the Taxable 1 status of the next item.

18 Paid out key/Tax status shift 2 key PD/
T/S2

Paid out: Press this key following a numeric entry to register money paid out from the drawer.
Tax shift 2: Press this key without numeric entry to change the Taxable 2 status of the next item.

19 Charge key CH

Use this key to register a charge sale.

20 Check key CHK

Use this key to register a check tender.
This key is also used for tax table 3 programming.

21 Merchandise subtotal key MD/
ST

Press this key to display and print the current subtotal (excludes add-on tax) amount.

22 Subtotal key SUB
TOTAL

Press this key to display and print the current subtotal (includes add-on tax) amount.

23 Cash amount tendered key CA/AMT
=/TEND

Press this key to register a cash sale.

• Calculator Mode

2 Drawer open key #/NS

4 Percent key %

12 Clear/All clear key C
CAC

13 Ten key pad 0, 1, ~ 9, 00, .

24 Arithmetic operation key 49/73
+ 1, 50/74
- 2, 51/75
× 3 and 52/76
÷ 4

17 Memory recall key PLU/
S.DEPT

22 Equal key CA/AMT
=/TEND

Basic Operations and Setups

How to read the printouts

- The journal and receipts are records of all transactions and operations.
- The contents printed on receipts and journal are identical, except the date printing line. (The date line is printed on receipts and reports.)
- You can choose the journal skip function (page 50).
If the journal skip function is selected, the cash register will print the total amount of each transaction, and the details of premium, discount and reduction operations only, without printing department and PLU item registrations on the journal.
- The following items can be skipped on receipts and journal.
 - Time
 - Consecutive number
 - Taxable status
 - Taxable amount

Receipt Sample

```

*****
* THANK YOU *
**  CALL AGAIN  **
* YOUR RECEIPT *
*****

* COMMERCIAL MESSAGE *
* COMMERCIAL MESSAGE *
* COMMERCIAL MESSAGE *
* COMMERCIAL MESSAGE *
* COMMERCIAL MESSAGE *
05-11-2000 12:34 0001
REG  C01      000123

DEPT01    1%  $1.00
DEPT02    1%  $2.00
          5 X  $1.00
DEPT03    1%  $5.00
TA1       $8.00
TX1       $0.40
TA2       $8.00
TX2       $0.80
TL        $9.20
CA        $10.00
CG        $0.80
          7 No
    
```

Logo message

Commercial message

Date/Time/Machine No.
Mode/Clerk/
Consecutive No.

Item counter

**Journal Sample
(Item lines Included)**

```

          12:33  0001
REG  C01      000122
DEPT01    1%  $1.00
DEPT02    1%  $2.00
TA1       $3.00
TX1       $0.15
CA        $3.15

          12:34  0001
REG  C01      000123
DEPT01    1%  $1.00
DEPT02    1%  $2.00
          5 X  $1.00
DEPT03    1%  $5.00
TA1       $8.00
TX1       $0.40
TA2       $8.00
TX2       $0.80
TL        $9.20
CA        $10.00
CG        $0.80
          7 No

          12:35  0001
REG  C01      000124
DEPT01    1%  $1.00
DEPT02    1%  $2.00
          5 X  $1.00
DEPT03    1%  $5.00
    
```

**Journal Sample
(Item lines Skipped)**

```

          12:32  0001
REG  C01      000121
TA1       $3.00
TX1       $0.15
CA        $3.15
          2 No

          12:33  0001
REG  C01      000122
TA1       $3.00
TX1       $0.15
CA        $3.15
          2 No

          12:34  0001
REG  C01      000123
TA1       $3.00
TX1       $0.15
TA2       $5.00
TX2       $0.20
TL        $8.35
CA        $10.00
CG        $1.75
          7 No

          12:35  0001
REG  C01      000124
TA1       $3.00
TX1       $0.15
TA2       $5.00
TX2       $0.20
    
```

In the operation examples contained in this manual, the print samples are what would be produced if the roll paper is being used for receipts. They are not actual size. Actual receipts are 58 mm wide. Also, all sample receipts and journals are printout images.

How to use your cash register

The following describes the general procedure you should use in order to get the most out of your cash register.

BEFORE business hours...

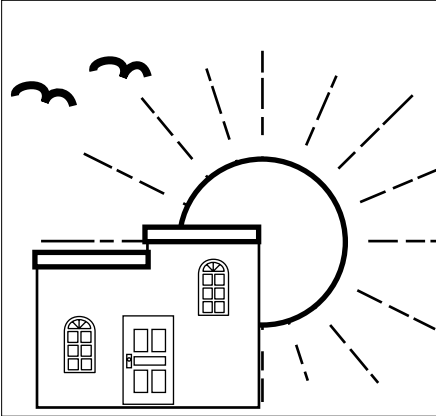

- Check to make sure that the cash register is plugged in securely. Page 8
- Check to make sure there is enough paper left on the roll. Page 9
- Read the financial totals to confirm that they are all zero. Page 79
- Check the date and time. Page 26

DURING business hours...

- Register transactions. Page 27
- Periodically read totals. Page 78



AFTER business hours...

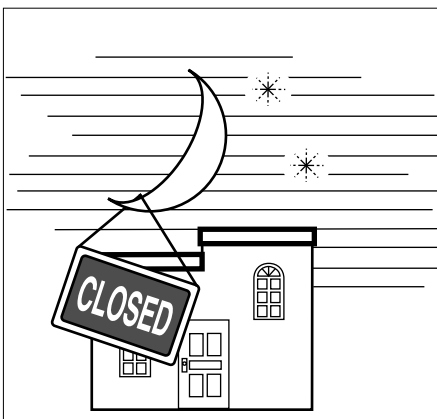

- Reset the daily totals. Page 47
- Remove the journal. Page 92
- Empty the cash drawer and leave it open. Page 19
- Take the cash and journal to the office.

Basic Operations and Setups

Displaying the time and date

You can show the time or date on the display of the cash register whenever there is no registration being made.

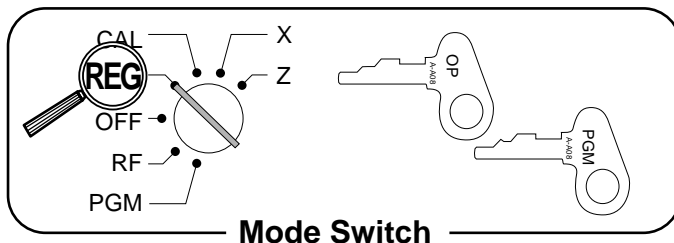

To display and clear the time

OPERATION	DISPLAY
 Time appears on the display	 Hour Minutes (24-hour system)
 Clears the time display	

To display and clear the date

OPERATION	DISPLAY
 Time appears on the display	 (Time is displayed first)
 Date appears on the display	 Month Day Year
 Clears the date display	

Preparing coins for change

You can use the following procedure to open the drawer without registering an item. This operation must be performed out of a sale.

(You can use the key instead of the key. See page 43.)

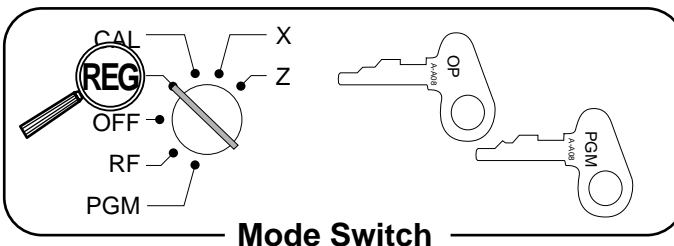

Opening the drawer without a sale

OPERATION	RECEIPT

Preparing and using department keys

Registering department keys

The following examples show how you can use the department keys in various types of registrations.

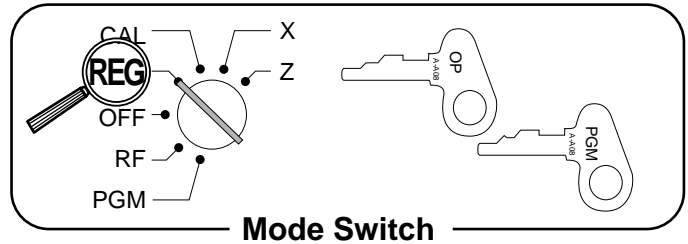

Single item sale

Example 1

Item	Unit price	\$1.00
	Quantity	1
	Dept.	1
	Taxable	1/2
Payment	Cash	\$1.15

OPERATION

1 00
Unit price
49/73
+ 25 1
Department
CA/AMT
= /TEND

RECEIPT

```
05-11-2000 08:40
REG 000002
DEPT01 1.00
TA1 1.00
TX1 0.05
TA2 1.00
TX2 0.10
CA $1.15
```

Date/time
Mode/consecutive No.
Department No./unit price
Taxable amount 1
Tax amount 1
Taxable amount 2
Tax amount 2
Cash total amount

Example 2

Item 1	Unit price	\$1.00
	Quantity	1
	Dept.	25
Item 2	Unit price	\$2.00
	Quantity	1
	Dept.	49
Item 3	Unit price	\$3.00
	Quantity	1
	Dept.	73
Payment	Cash	\$10.00

OPERATION

1 00 **DEPT SHIFT** **49/73**
+ 25 1
Designating from department 25 to 48, press **DEPT SHIFT** once (- 2 - shows),
49 to 72, press **DEPT SHIFT** twice, (- 3 - shows),
73 to 96, press **DEPT SHIFT** three times (- 4 - shows).
2 00
DEPT SHIFT **DEPT SHIFT** **49/73**
+ 25 1
3 00
DEPT SHIFT **DEPT SHIFT** **DEPT SHIFT** **49/73**
+ 25 1
CA/AMT
= /TEND

RECEIPT

```
05-11-2000 08:45
REG 000003
DEPT25 1.00
DEPT49 2.00
DEPT73 3.00
TL $6.00
CA 10.00
CG 4.00
```

Example 3

Item	Unit price	\$3.00
	Quantity	1
	Dept.	1
	Taxable	(1/2)→2
Payment	Cash	\$3.30

OPERATION

RC/T/S1 **3 00** **49/73**
+ 25 1
Shifting taxable dept. to nontaxable by depressing **RC/T/S1**, **PD/T/S2** before numeric.
CA/AMT
= /TEND

RECEIPT

```
05-11-2000 08:50
REG 000004
DEPT01 3.00
TA2 3.00
TX2 0.30
CA $3.30
```

Tax status
Taxable amount 2
Tax amount 2

Basic Operations and Setups

Repeat

Item	Unit price	\$1.50
	Quantity	3
	Dept.	1
	Taxable	1/2
Payment	Cash	\$10.00

1 5 0 49/73
+ 25
+ 1

1 0 00 49/73
+ 25
+ 1

SUB
TOTAL

1 0 00 CA/AMT
= /TEND

05-11-2000 08:55		REG	000005
DEPT01	1 1/2	\$1.50	Repeat
DEPT01	1 1/2	\$1.50	
DEPT01	1 1/2	\$1.50	
TA1		\$4.50	Repeat
TX1		\$0.23	
TA2		\$4.50	
TX2		\$0.45	
TL		\$5.18	
CA		\$10.00	
CG		\$4.82	

Multiplication

Item	Unit price	\$1.00
	Quantity	12.5
	Dept.	1
	Taxable	1/2
Payment	Cash	\$20.00

1 2 . 5 FOR
DATE
TIME

Quantity
(4-digit integer/2-digit decimal)

1 00 49/73
+ 25
+ 1

SUB
TOTAL

2 0 00 CA/AMT
= /TEND

05-11-2000 09:00		REG	000006
	12.5 X	@1.00	Quantity/unit price
DEPT01	1 1/2	\$12.50	
TA1		\$12.50	
TX1		\$0.63	
TA2		\$12.50	
TX2		\$1.25	
TL		\$14.38	
CA		\$20.00	
CG		\$5.62	

Split sales of packaged items

Item	Unit price	4 for \$10.00
	Quantity	3
	Dept.	1
	Taxable	1/2
Payment	Cash	\$10.00

3 FOR
DATE
TIME

Quantity being purchased
(4-digit integer/2-digit decimal)

4 FOR
DATE
TIME

Quantity being purchased
(4-digit integer/2-digit decimal)

1 0 00 49/73
+ 25
+ 1

Package price

SUB
TOTAL

1 0 00 CA/AMT
= /TEND

05-11-2000 09:05		REG	000007
	3 X	@4 /	Quantity Package quantity/ unit price
DEPT01	1 1/2	\$7.50	
TA1		\$7.50	
TX1		\$0.38	
TA2		\$7.50	
TX2		\$0.75	
TL		\$8.63	
CA		\$10.00	
CG		\$1.37	

Programming department keys

To program a unit price for each department

Unit price

Example:

\$1.00 ⇨ 1 0 0
 \$10.25 ⇨ 1 0 2 5
 \$1234.56 ⇨ 1 2 3 4 5 6

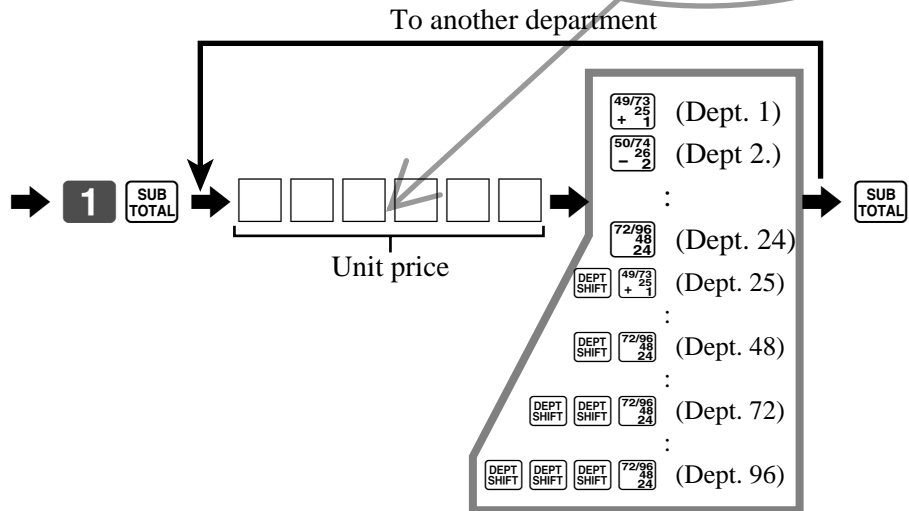
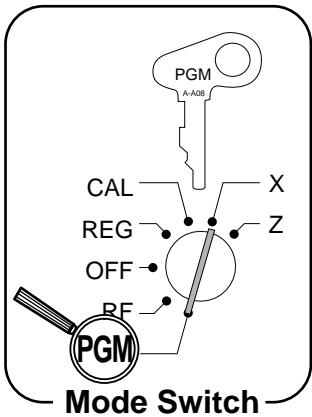

To program the tax calculation status for each department

Tax calculation status

This specification defines which tax table should be used for automatic tax calculation.

See page 13 for information on setting up the tax tables.

Note: If you require tax table 3, please refer to page 39.

Programming procedure

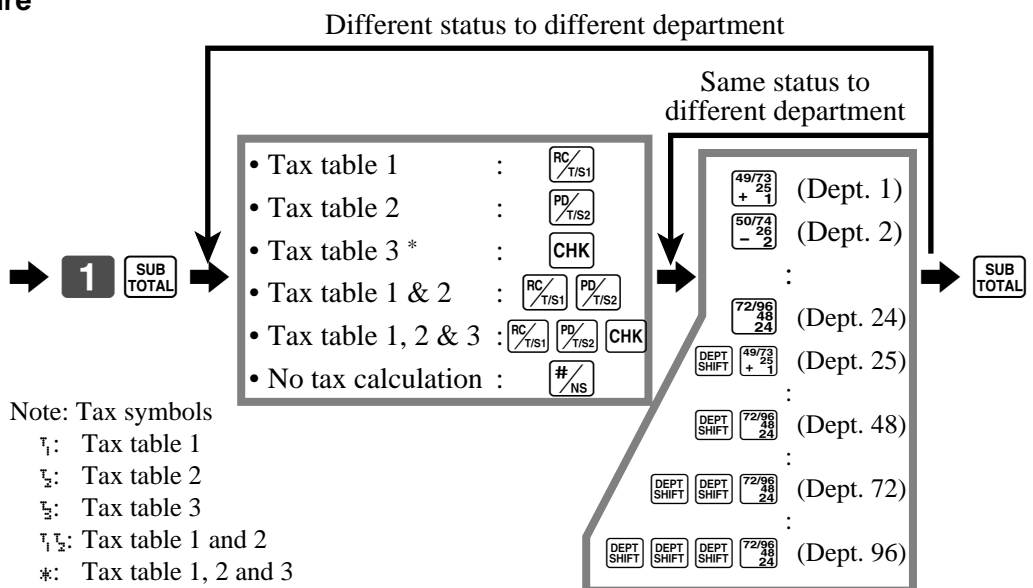
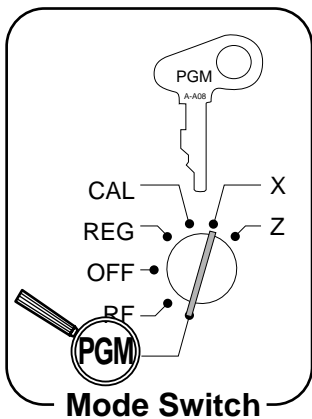

Note: Tax symbols

- T₁: Tax table 1
- T₂: Tax table 2
- T₃: Tax table 3
- T₁T₂: Tax table 1 and 2
- *: Tax table 1, 2 and 3

Tax status for the departments are initialized as follow:

- Department 01 ~ 12: Tax table 1 and 2,
- Department 13 ~ 96: No tax calculation.

* Use the **CHK** key for tax table 3 programming.

Basic Operations and Setups

Registering department keys by programming data

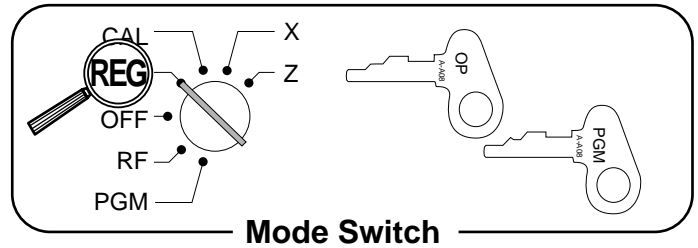

Preset price

OPERATION

RECEIPT

Item	Unit price	(\$1.00) _{preset}
	Quantity	1
	Dept.	2
	Taxable	No
Payment	Cash	\$1.00

50/74
- 26
2

CA/AMT
=/TEND

```
05-11-2000 09:10
REG 000008
DEPT02 $1.00
CA $1.00
```

Department No./
unit price

Preset tax status (Add-on tax)

OPERATION

RECEIPT

Item 1	Unit price	(\$2.00) _{preset}
	Quantity	5
	Dept.	3
	Taxable	(1) _{preset}
Item 2	Unit price	(\$2.00) _{preset}
	Quantity	1
	Dept.	3
	Taxable	No
Payment	Cash	\$20.00

5 X/ FOR
DATE
TIME

51/75
X 27
3

RC/T/S1 51/79
X 27
3

SUB
TOTAL

2 0 00 CA/AMT
=/TEND

```
05-11-2000 09:15
REG 000009
5 X $2.00
DEPT03 T $10.00
DEPT03 $2.00
TA1 $10.00
TX1 $0.50
TL $12.50
CA $20.00
CG $7.50
```

Tax status

Taxable Amount 1

Tax amount 1

Preparing and using PLUs

This section describes how to prepare and use PLUs.

CAUTION:

Before you use PLUs, you must first program the unit price and tax status for each PLU.

Programming PLUs

To program a unit price for each PLU

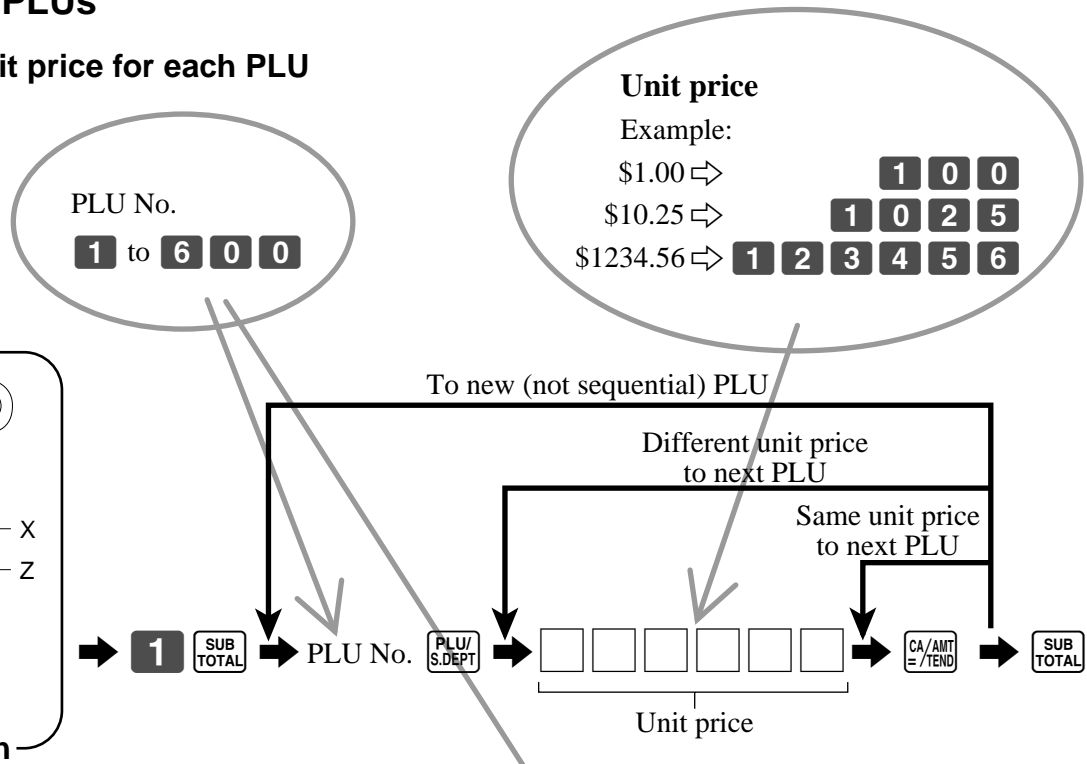

To program tax calculation status for each PLU

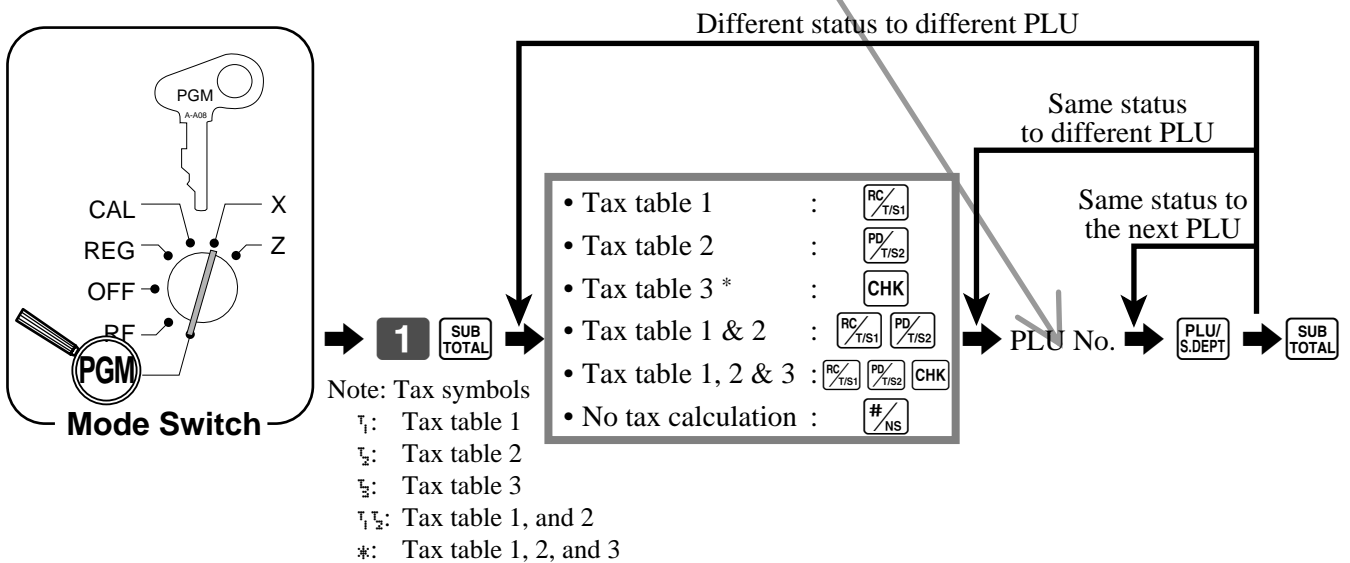

All PLUs are initialized as no tax calculation.

Note: If you require tax table 3, please refer to page 39.

* Use the **CHK** key for tax table 3 programming.

Basic Operations and Setups

Registering PLUs

The following examples show how you can use PLUs in various types of registrations.

Registering by subdepartment, see the "Convenient Operations and Setups" on page 64.

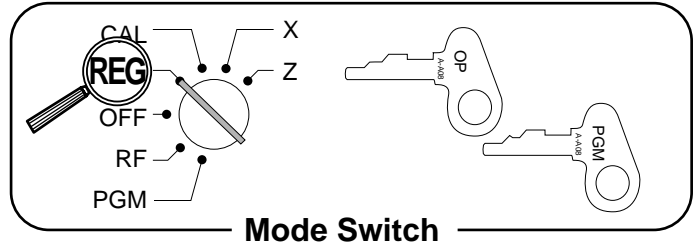

PLU single item sale

OPERATION

Item	Unit price	(\$2.50) _{preset}
	Quantity	1
	PLU	14
	Taxable	(2) _{preset}
Payment	Cash	\$3.00

1 4 PLU code

3 00 CA/AMT = /TEND

Buttons: **PLU/S.DEPT**, **SUB TOTAL**

RECEIPT

```

05-11-2000 09:20
REG 000010
PLU014  1/2  $2.50
TA2      $2.50
TX2      $0.25
TL              $2.75
CA              $3.00
CG              $0.25
    
```

PLU No./unit price

PLU repeat

OPERATION

Item	Unit price	(\$2.50) _{preset}
	Quantity	3
	PLU	14
	Taxable	(2) _{preset}
Payment	Cash	\$10.00

1 4 **PLU/S.DEPT**

1 0 00 CA/AMT = /TEND

Buttons: **PLU/S.DEPT**, **SUB TOTAL**

RECEIPT

```

05-11-2000 09:25
REG 000011
PLU014  1/2  $2.50
PLU014  1/2  $2.50
PLU014  1/2  $2.50
TA2      $7.50
TX2      $0.75
TL              $8.25
CA              $10.00
CG              $1.75
    
```

PLU multiplication

OPERATION

Item	Unit price	(\$1.20) _{preset}
	Quantity	15
	PLU	2
	Taxable	(2) _{preset}
Payment	Cash	\$20.00

1 5 **X / FOR DATE TIME**

Quantity (4-digit integer/2-digit decimal)

2 **PLU/S.DEPT**

2 0 00 CA/AMT = /TEND

Buttons: **PLU/S.DEPT**, **SUB TOTAL**

RECEIPT

```

05-11-2000 09:30
REG 000012
      15 X  $1.20
PLU002  1/2  $18.00
TA2      $18.00
TX2      $1.80
TL              $19.80
CA              $20.00
CG              $0.20
    
```

PLU split sales of packaged item

OPERATION

RECEIPT

Item	Unit price	(5for\$20.00) _{preset}
	Quantity	3
	PLU	28
	Taxable	(2) _{preset}
Payment	Cash	\$15.00

Quantity
(4-digit integer/2-digit decimal)

3 FOR DATE TIME

5 FOR DATE TIME

2 **8** PLU/S.DEPT

SUB TOTAL

1 **5** **00** CA/AMT =/TEND

```

05-11-2000 09:35
REG                                000013

      3 X
      @5 /
PLU028                               $12.00
TA2                                   $12.00
TX2                                   $1.20
TL                                   $13.20
CA                                   $15.00
CG                                   $1.80
    
```

Basic Operations and Setups

Preparing and using discounts

This section describes how to prepare and register discount.

Programming discounts

You can use the [%] key to register discounts (percentage decreases). The more detailed informations about the discount (and premium) are described in the "Registering discounts and premiums" section in the "Convenient Operations and setups" on page 70.

To program a rate to the [%] key

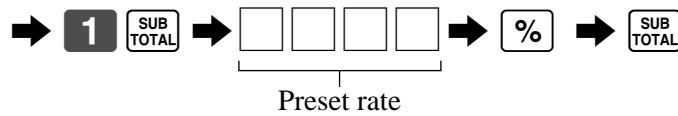
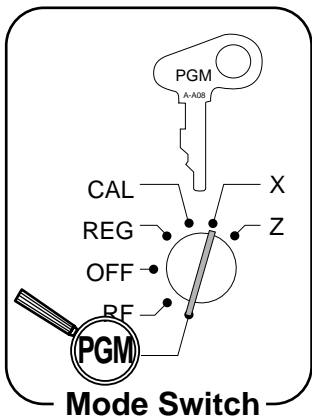

Example:

- 10% ⇒ 1 0
- 5.5% ⇒ 5 . 5
- 12.34% ⇒ 1 2 . 3 4

To program tax status to the [%] key

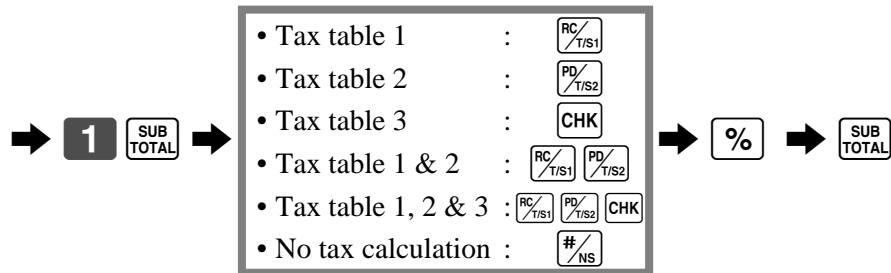
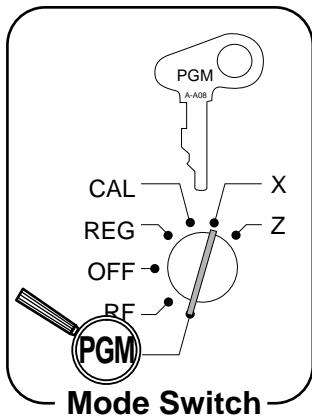

Note: Tax symbols

- T₁: Tax table 1
- T₂: Tax table 2
- T₃: Tax table 3
- T₁T₂: Tax table 1, and 2
- *: Tax table 1, 2, and 3

Tax status for the [%] key is initialized as tax table 1, 2 and 3.

Note: If you require tax table 3, please refer to page 39.

Registering discounts

The following example shows how you can use the **%** key in various types of registration.

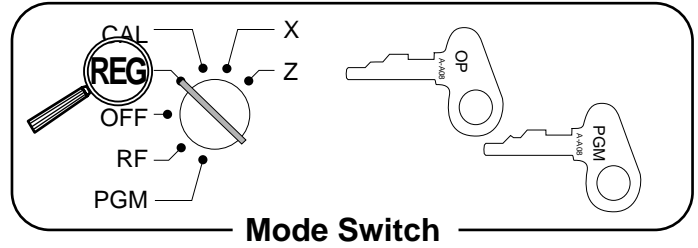

Discount for items and subtotals

OPERATION

RECEIPT

Item 1	Unit price	\$5.00
	Quantity	1
	Dept.	1
	Taxable	(1) _{preset}
Item 2	Unit price	(\$10.00) _{preset}
	Quantity	1
	PLU	16
	Taxable	(2) _{preset}
Discount	Rate	(5%) _{preset}
Subtotal discount	Rate	3.5%
	Taxable	all
Payment	Cash	\$16.00

5 00 **49/73 + 25 1**

1 6 **PLU/SDEPT**

%

Applies the preset discount rate to the last item registered.

MD/ST

For this operation, hit this key instead of **SUB/TOTAL**.

3 . 5 **%**

The input value takes priority of the preset value.

SUB/TOTAL

1 6 00 **CA/AMT =/TEND**

05-11-2000	10:40	
REG		000014
DEPT01	1	\$5.00
PLU016	1	\$10.00
5%		
%	1	-0.50
ST		\$14.50
3.5%		
%	*	-0.51
TA1		\$4.82
TX1		\$0.24
TA2		\$9.17
TX2		\$0.92
TL		\$15.15
CA		\$16.00
CG		\$0.85

- You can manually input rates up to 4 digits long (0.01% to 99.99%).

Taxable status of the **%** key



- Whenever you perform a discount operation on the last item registered, the tax calculation for discount amount is performed in accordance with the tax status programmed for that item.
- Whenever you perform a discount operation on a subtotal amount, the tax calculation for the subtotal amount is performed in accordance with the tax status programmed for the **%** key.

Basic Operations and Setups

Preparing and using reductions

This section describes how to prepare and register reductions.

Programming for reductions

You can use the  key to reduce single item or subtotal amounts. The following procedure lets you program the tax calculation method for the  key.

To program tax calculation status

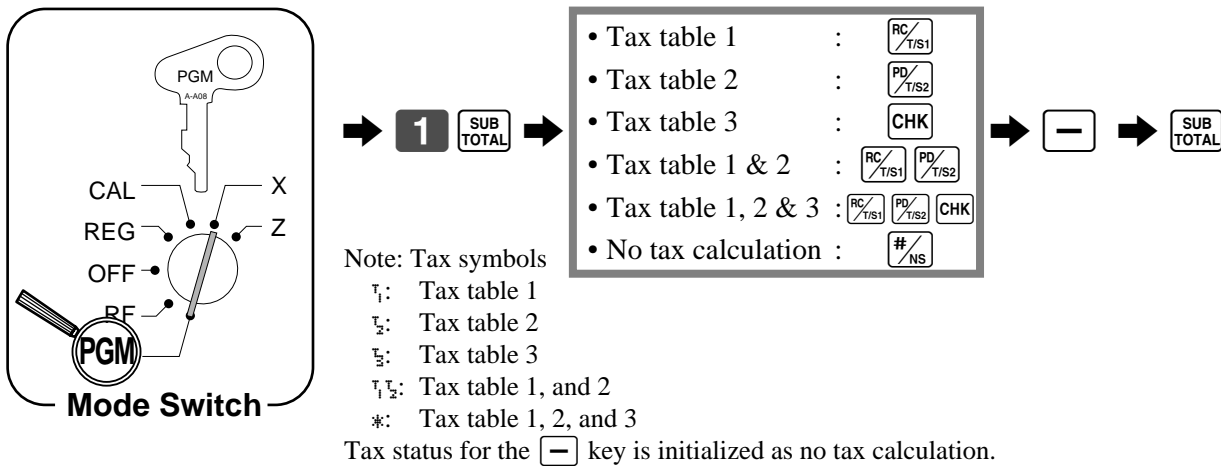

Taxable status of the key

The tax calculation for the reduction amount is performed in accordance with the tax status programmed for the  key, regardless of whether the reduction is performed on the last item registered or a subtotal amount.

Note: If you require tax table 3, please refer to page 39.

To program preset reduction amount

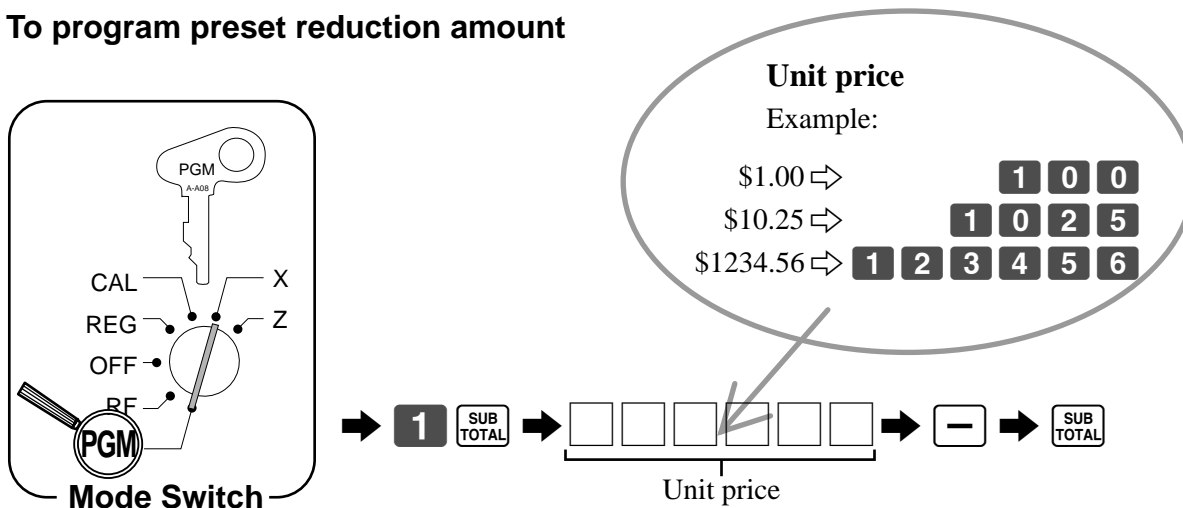

Registering reductions

The following examples show how you can use the  key in various types of registration.

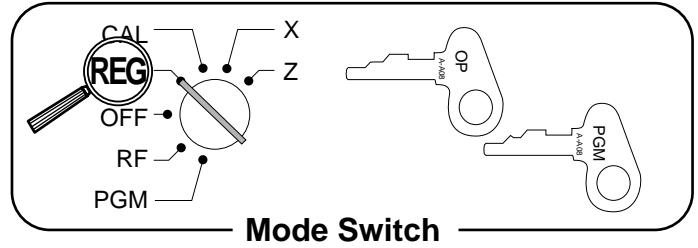







Reduction for items

OPERATION

RECEIPT

Item 1	Unit price	\$5.00
	Quantity	1
	Dept.	1
	Taxable	(1) _{preset}
Reduction	Amount	\$0.25
Item 2	Unit price	(\$6.00) _{preset}
	Quantity	1
	PLU	45
	Taxable	(1) _{preset}
Reduction	Amount	(\$0.50) _{preset}
Payment	Cash	\$11.00

5 00  
2 5 
 Reduces the last amount registered by the value input.
4 5 

1 1 00 

```

05-11-2000 10:45
REG                000015
DEPT01            7    $5.00
-                  -0.25
PLU045            7    $6.00
-                  -0.50
TA1                $11.00
TX1                $0.55
TL                $10.80
CA                 $11.00
CG                 $0.20
    
```







- You can manually input reduction values up to 7 digits long.
- The amount you input for the reduction is neither subtracted from the department nor PLU totalizer.

Reduction for subtotal

OPERATION

RECEIPT

Item 1	Unit price	\$3.00
	Quantity	1
	Dept.	1
	Taxable	(1) _{preset}
Item 2	Unit price	\$4.00
	Quantity	1
	Dept.	2
	Taxable	(2) _{preset}
Subtotal Reduction	Amount	\$0.75
Payment	Cash	\$7.00

3 00  
4 00 

7 5 
 Reduces the subtotal by the value input here.

7 00 

```

05-11-2000 10:50
REG                000016
DEPT01            7    $3.00
DEPT02            2    $4.00
-                  -0.75
TA1                $3.00
TX1                $0.15
TA2                $4.00
TX2                $0.40
TL                $6.80
CA                 $7.00
CG                 $0.20
    
```

Basic Operations and Setups

Calculating the merchandise subtotal

Use the operation shown below to calculate the merchandise subtotal, which includes the actual cost of the merchandise only without the add-on tax.

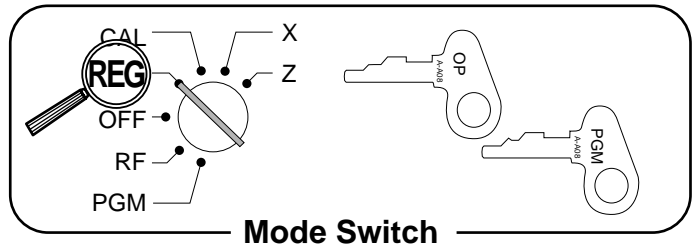

Calculation merchandise subtotal

OPERATION

DISPLAY

Item 1	Unit price	\$1.00
	Quantity	1
	Dept.	1
	Taxable	(1) _{preset}
Item 2	Unit price	\$2.00
	Quantity	1
	Dept.	2
	Taxable	(2) _{preset}
Item 3	Unit price	\$3.00
	Quantity	1
	Dept.	3
	Taxable	(1) _{preset}
Payment	Cash	\$10.00

1 00 $\frac{49}{25} + \frac{73}{1}$

01 1.00

2 00 $\frac{50}{26} - \frac{74}{2}$

02 2.00

3 00 $\frac{51}{27} \times \frac{75}{3}$

03 3.00

MD/ST

6.00

Calculates the merchandise subtotal.

SUB TOTAL

6.40

Calculates the subtotal (with add-on tax).

1 0 00 CA/AMT = /TEND

3.60

RECEIPT

```

05-11-2000 10:55
REG 000017

DEPT01  1  $1.00
DEPT02  2  $2.00
DEPT03  1  $3.00
ST      $6.00
TA1     $4.00
TX1     $0.20
TA2     $2.00
TX2     $0.20
TL      $6.40
CA      $10.00
CG      $3.60
    
```

- For a partial tender operation, you should press the **SUB TOTAL** key instead of the **MD/ST** key.

Shifting taxable 1/2 status of an item

By pressing "Tax Shift" key, you can shift the taxable 1/2 status of an item.

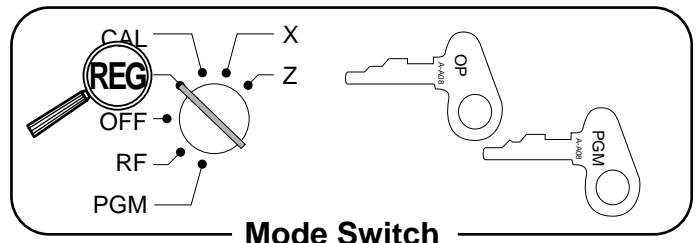

Mode Switch

Calculation merchandise subtotal

OPERATION

RECEIPT

Item 1	Unit price	\$4.00
	Quantity	1
	Dept.	1
	Taxable	(2) _{preset}
Item 2	Unit price	\$2.00
	Quantity	1
	Dept.	2
	Taxable	(No)→1
Item 3	Unit price	\$6.00
	Quantity	1
	Dept.	3
	Taxable	(1)→1, 2
Item 4	Unit price	\$7.00
	Quantity	1
	Dept.	4
	Taxable	(2)→No
Payment	Cash	\$21.00

4 00 $\frac{49}{25} + 1$
 Pressing $\frac{RC}{T/S1}$ changes the tax status from Nontaxable to Taxable 1

2 00 $\frac{50}{26} - 2$
 Pressing $\frac{PD}{T/S2}$ changes the tax status from Taxable 1 to Taxable 1, 2

6 00 $\frac{51}{27} \times 3$
 Pressing $\frac{PD}{T/S2}$ changes the tax status from Taxable 2 to Nontaxable

7 00 $\frac{52}{28} + 4$
 Pressing $\frac{PD}{T/S2}$ changes the tax status from Taxable 2 to Nontaxable

2 1 00 SUB TOTAL
 CA/AMT =/TEND

```

05-11-2000 11:00
REG 000018
DEPT01 5 $4.00
DEPT02 7 $2.00
DEPT03 15 $6.00
DEPT04 15 $7.00
TA1 $8.00
TX1 $0.40
TA2 $10.00
TX2 $1.00
TL $20.40
CA $21.00
CG $0.60
    
```

Important!

- To change the tax status of the next item to be registered, be sure to press $\frac{RC}{T/S1}$, $\frac{PD}{T/S2}$ without inputting any value.

(Note: You cannot change to tax status 3 during registration. Tax status 3 will only work if it is programmed for a particular department or PLU.)

- If the last item registered is programmed as nontaxable, a premium/discount ($\frac{\%}{}$ key) operation on this item is always nontaxable.

In this case, you cannot manually change the tax status to Taxable 1 or 2 by pressing the $\frac{RC}{T/S1}$, $\frac{PD}{T/S2}$ keys.

Basic Operations and Setups

Registering charge and check payments

The following examples show how to register charges and payments by check.

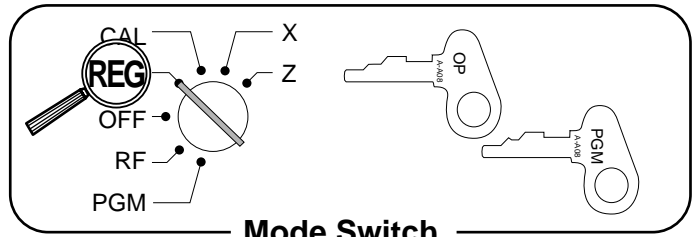

Check

OPERATION

RECEIPT

Item	Unit price	\$10.00
	Quantity	1
	Dept.	1
	Taxable	(1) _{preset}
Payment	Check	\$20.00

1 0 00 49/73
25
+ 1
SUB
TOTAL
 2 0 00 CHK

```
05-11-2000 11:05
REG 000019
DEPT01  1  $10.00
TA1      $10.00
TX1      $0.50
TL      $10.50
CHK      $20.00
CG      $9.50
```

Charge

OPERATION

RECEIPT

Item	Unit price	\$15.00
	Quantity	1
	Dept.	4
	Taxable	(2) _{preset}
Reference	Number	0123
Payment	Charge	\$16.50

1 5 00 52/76
28
+ 4
SUB
TOTAL
 0 1 2 3 #/
NS
CH

```
05-11-2000 11:10
REG 000020
DEPT04  4  $15.00
# / NS 0123 Reference No.
TA2      $15.00
TX2      $1.50
CH      $16.50
```

Mixed tender (cash, charge and check)

OPERATION

RECEIPT

Item	Unit price	\$55.00
	Quantity	1
	Dept.	4
	Taxable	(2) _{preset}
Payment	Check	\$30.00
	Cash	\$3.00
	Charge	\$27.50

5 5 00 52/76
28
+ 4
SUB
TOTAL
 3 0 00 CHK
 3 00 CA/AMT
=/TEND
CH

```
05-11-2000 11:15
REG 000021
DEPT04  4  $55.00
TA2      $55.00
TX2      $5.50
TL      $60.50
CHK      $30.00
CA      $3.00
CH      $27.50
```

Registering returned goods in the REG mode

The following example shows how to use the **RF** key in the REG mode to register goods returned by customers.

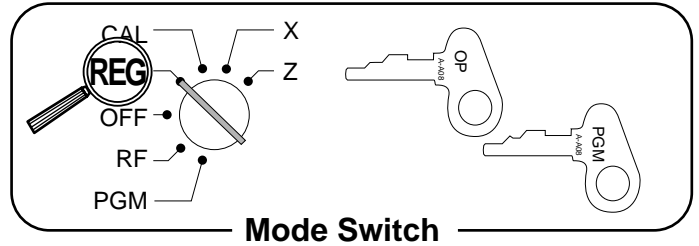

OPERATION

RECEIPT

Item 1	Unit price	\$2.35
	Quantity	1
	Dept.	1
	Taxable	(1) _{preset}
Item 2	Unit price	\$2.00
	Quantity	1
	Dept.	2
	Taxable	(2) _{preset}
Item 3	Unit price	(\$1.20) _{preset}
	Quantity	1
	PLU	1
	Taxable	(2) _{preset}
Returned Item 1	Unit price	\$2.35
	Quantity	1
	Dept.	1
	Taxable	(1) _{preset}
Returned Item 3	Unit price	(\$1.20) _{preset}
	Quantity	1
	PLU	1
	Taxable	(2) _{preset}
Payment	Cash	\$2.20

2 3 5 49/73
25
+ 1
2 00 50/74
- 26
2
1 PLU/
S.DEPT RF
2 3 5 49/73
25
+ 1
 Pressing **RF** specifies that the next item registered is a return.
1 PLU/
S.DEPT RF
 You have to press **RF** before registering each returned item.
SUB
TOTAL
CA/AMT
=/TEND

```

05-11-2000 11:20
REG 000022
DEPT01  1/1  $2.35
DEPT02  1/2  $2.00
PLU001  1/3  $1.20
RF .....
DEPT01  1/1  -2.35
RF .....
PLU001  1/3  -1.20
TA2  $2.00
TX2  $0.20
CA  $2.20
    
```

Basic Operations and Setups

Registering returned goods in the RF mode

The following examples show how to use the RF mode to register goods returned by customers.

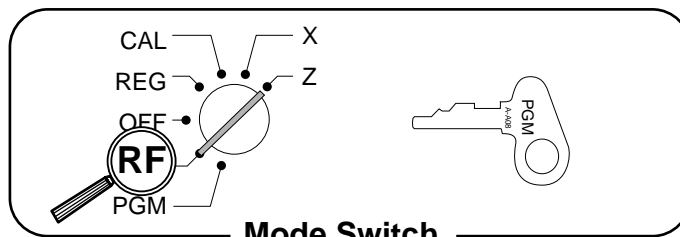

Normal refund transaction

OPERATION

Returned Item 1	Unit price	\$1.50
	Quantity	2
	Dept.	1
	Taxable	1
Returned Item 2	Unit price	(\$1.20) _{preset}
	Quantity	6
	PLU	2
	Taxable	1
Payment	Cash	\$11.07

1 **5** **0** 49/73
+ 25
+ 1
49/73
+ 25
+ 1
6 X / FOR
DATE
TIME
2 PLU/
S.DEPT
SUB
TOTAL
CA/AMT
=/TEND

RECEIPT

05-11-2000 11:25		
RF		000023
DEPT01	1	\$1.50
DEPT01	1	\$1.50
6 X		\$1.20
PLU002	2	\$7.20
TA1		\$3.00
TX1		\$0.15
TA2		\$7.20
TX2		\$0.72
CA		\$11.07

RF mode symbol

Reduction of amounts paid on refund

OPERATION

Returned Item 1	Unit price	\$4.00
	Quantity	1
	Dept.	3
Reduction	Amount	\$0.15
Returned Item 2	Unit price	(\$1.20) _{preset}
	Quantity	1
	PLU	2
Discount	Rate	(5%) _{preset}
Payment	Cash	\$5.30

4 **00** 51/75
x 27
x 3
1 **5** -
2 PLU/
S.DEPT
%
SUB
TOTAL
CA/AMT
=/TEND

RECEIPT

05-11-2000 11:30		
RF		000024
DEPT03	1	\$4.00
-		-0.15
PLU002	2	\$1.20
5%		
%		-0.06
TA1		\$4.00
TX1		\$0.20
TA2		\$1.14
TX2		\$0.11
CA		\$5.30

Important!

To avoid miss registrations in the RF mode, return the mode switch to the former position immediately.

Registering money received on account

The following example shows how to register money received on account. This registration must be performed out of a sale.

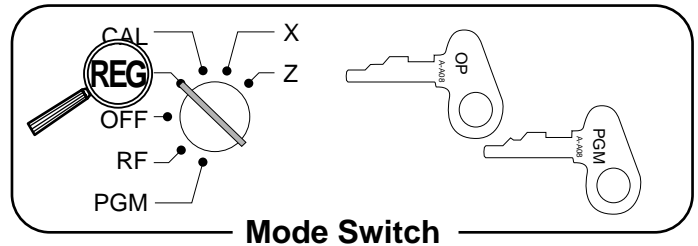

OPERATION

Received amount	\$700.00
-----------------	----------

7 00 00 RC/T/S1

Amount can be up to 8 digits.

RECEIPT

05-11-2000	11:35
REG	000025
RC	\$700.00

Registering money paid out

The following example shows how to register money paid out from the register. This registration must be performed out of a sale.

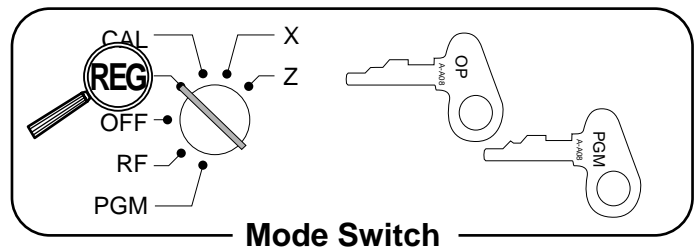

OPERATION

Paid out amount	\$1.50
-----------------	--------

1 5 0 PD/T/S2

Amount can be up to 8 digits.

RECEIPT

05-11-2000	11:40
REG	000026
PD	\$1.50

Basic Operations and Setups

Making corrections in a registration

There are three techniques you can use to make corrections in a registration.

- To correct an item that you input but not yet registered.
- To correct the last item you input and registered.
- To cancel all items in a transaction.

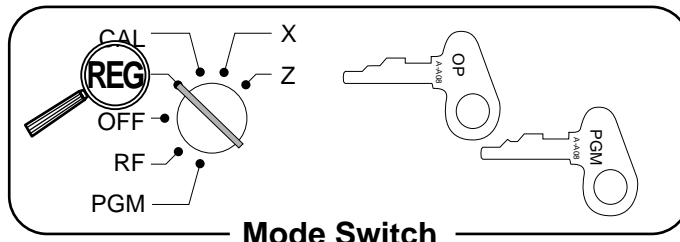

To correct an item you input but not yet registered

OPERATION

RECEIPT

<p>2 00 C <small>C/C</small></p> <p>1 00 49/73 + 25 1</p> <p>1 2 X/DATE TIME</p> <p>1 1 C <small>C/C</small></p> <p>1 1 X/DATE TIME</p> <p>2 00 50/74 - 26 2</p> <p>2 C <small>C/C</small></p> <p>3 PLU/ S.DEPT</p> <p>1 5 PLU/ S.DEPT</p> <p>6 00 C <small>C/C</small></p> <p>1 5 PLU/ S.DEPT</p> <p>Enter subdepartment No. again.</p> <p>1 0 00 PRICE</p> <p>SUB TOTAL</p> <p>1 0 00 C <small>C/C</small></p> <p>1 5 00 CA/AMT = /TEND</p> <p>CH</p>	<p>— Correction of unit price</p> <p>— Correction of quantity</p> <p>— Correction of PLU No.</p> <p>— Correction of subdepartment unit price (See page 67 for registering)</p> <p>— Correction of partial tender amount</p>
--	---

05-11-2000 11:45	
REG	000027
DEPT01	1 \$1.00
11 X	@2.00
DEPT02	5 \$22.00
PLU003	1 \$1.30
PLU015	1 \$10.00
TA1	\$12.30
TX1	\$0.62
TA2	\$22.00
TX2	\$2.20
TL	\$37.12
CA	\$15.00
CH	\$22.12

To correct an item you input and registered

OPERATION



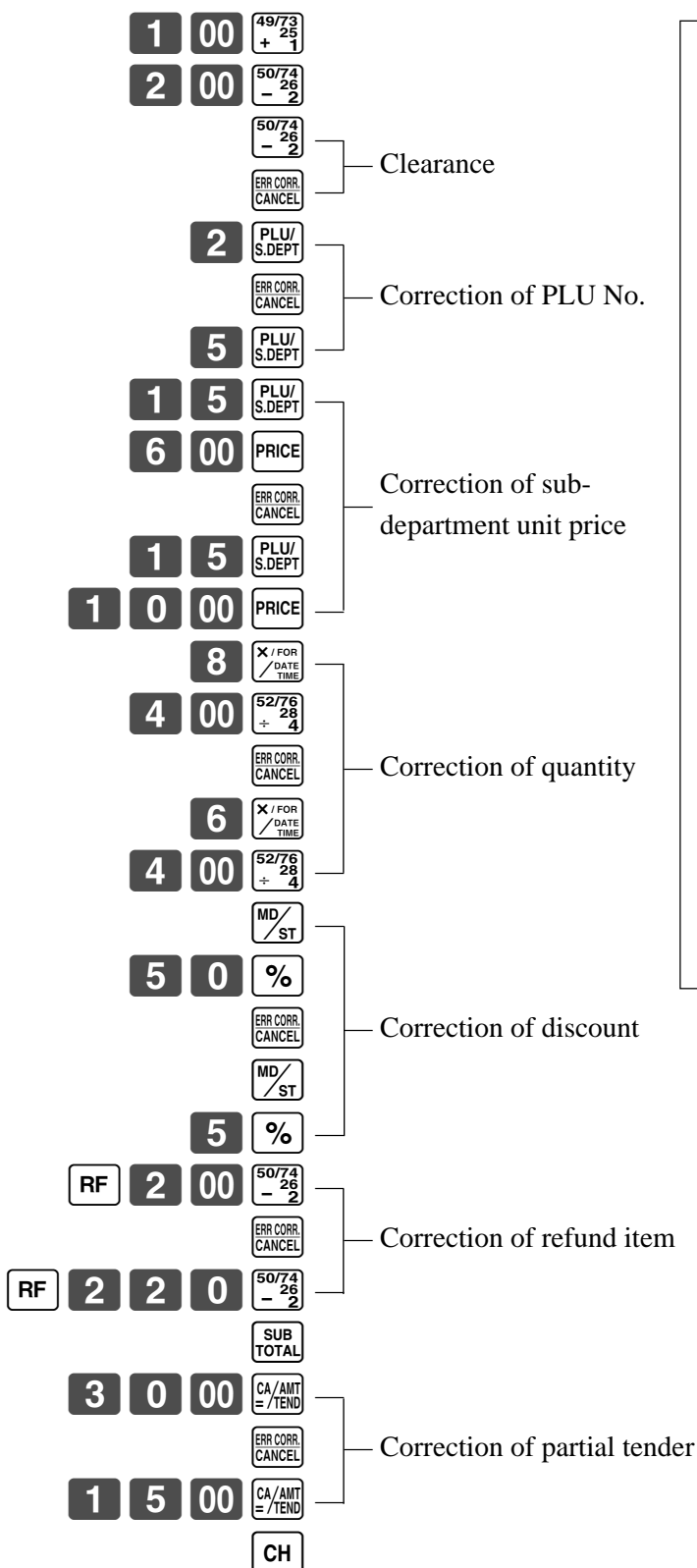



RECEIPT



05-11-2000	11:50		
REG		000028	
DEPT01	1	\$1.00	
DEPT02	1/2	\$2.00	
DEPT02	1/2	\$2.00	
CORR		-2.00	
PLU002	1/2	\$1.20	
CORR		-1.20	
PLU005	1	\$1.50	
PLU015	1	\$6.00	
CORR		-6.00	
PLU015	1	\$10.00	
	8 X	@4.00	
DEPT04	1/2	\$32.00	
CORR		-32.00	
	6 X	@4.00	
DEPT04	1/2	\$24.00	
ST		\$38.50	
	50%		
%	*	-19.25	
CORR		\$19.25	
ST		\$38.50	
	5%		
%	*	-1.93	
RF		
DEPT02	1/2	-2.00	
CORR		\$2.00	
RF		
DEPT02	1/2	-2.20	
TA1		\$11.87	
TX1		\$0.59	
TA2		\$22.50	
TX2		\$2.25	
TL		\$37.21	
CA		\$30.00	
CORR		-30.00	
CA		\$15.00	
CH		\$22.21	

Basic Operations and Setups

To cancel all items in a transaction

OPERATION	RECEIPT
<p>1 00 </p> <p>2 00 </p> <p>3 00 </p> <p>4 00 </p> <p></p>	<pre> 05-11-2000 11:55 REG 000029 DEPT01 1 \$1.00 DEPT02 2 \$2.00 DEPT03 1 \$3.00 DEPT04 2 \$4.00 ST \$10.00 CANCEL </pre>
<p>Pressing  key is necessary to cancel the transaction.</p> <p></p>	

Important!

- Note that the number of items included in the transaction to be cancelled is limited (25 ~ 49 items), depending on the complexity of the transaction. If you try to cancel a transaction that exceeds the limit, an error occurs (E027).
In case of occurrence of this error, register these items in the RF mode.
- You can program the cash register that this cancel operation is not allowed.

No sale registration

You can use the following procedure to open the drawer without registering a sale. This operation must be performed out of a sale.

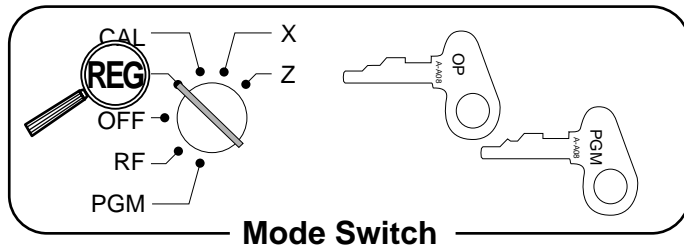

OPERATION	RECEIPT
<p></p>	<pre> 05-11-2000 12:00 REG 000030 #/NS </pre>

Printing the daily sales reset report

This report shows daily sales totals.

OPERATION

REPORT

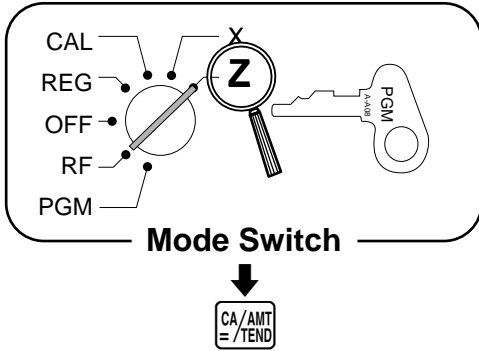

05-11-2000 12:05			Date/time
Z		000031	Reset mode/consecutive No.
0000 DAILY	Z	0001	Report code/report title/reset symbol/ reset counter
DEPT01	QT	15	Department No./No. of items *1
		\$339.50	Department amount *1
DEPT02	QT	19	
		\$62.70	
DEPT03	QT	31	
		\$139.10	
DEPT04	QT	23	
		\$332.67	
NON-LINK_DEPT	QT	10	Non-link department No. of items
		\$94.90	Non-link department amount

GRS	QT	253	Gross No. of items
		\$1146.90	Gross sales amount
NET	No	100	No. of customers
		\$1217.63	Net sales amount
CAID		\$903.06	Cash in drawer amount
CHID		\$197.17	Charge in drawer amount
CKID		\$183.60	Check in drawer amount
TA1		\$732.56	Taxable amount 1 *2
TX1		\$43.96	Tax amount 1 *2
TA2		\$409.72	Taxable amount 2 *2
TX2		\$21.55	Tax amount 2 *2
TA3		\$272.50	Taxable amount 3 *2
TX3		\$8.18	Tax amount 3 *2
CANCEL	No	2	Cancellation count
		\$108.52	Cancellation amount
RF MODE	No	2	Refund mode operation count *3
		\$3.74	Refund mode operation amount *3

CA	No	81	Cash sales count *1
		\$836.86	Cash sales amount *1
CH	No	10	Charge sales count *1
		\$197.17	Charge sales amount *1
CHK	No	9	Check sales count *1
		\$183.60	Check sales amount *1
-	No	8	Subtraction count *1
		\$3.00	Subtraction amount *1
%	No	10	Discount count *1
		\$4.62	Discount amount *1
RF	No	7	Refund key count *1 *3
		\$27.79	Refund key amount *1 *3
CORR	No	10	Error correction count *1
		\$12.76	Error correction amount
#/NS	No	5	No sale count *1
RC	No	2	Received on Account count *1
		\$78.00	Received on Account amount *1
PD	No	1	Paid out count *1
		\$6.80	Paid out amount *1

GT		\$0000001217.63	Non-resettable grand-sales total

*1 Zero totalled departments/transaction keys (the amount and item numbers are both zero) are not printed.

*2 Taxable amount and tax amount are printed only the corresponding tax table is programmed.

*3 These items can be skipped by programming.

Convenient Operations and Setups

This section describes more sophisticated setups and operations that you can use to suit the needs of your retail environment.

Clerk control function, Post-finalization receipt format, General printing control, Compulsory, Machine features

About the clerk control function

To keep track of the registrations performed by different clerks, specify the clerk control function.

In case of selecting the clerk control function, signing on operation is necessary before registering, programming or issuing reports.

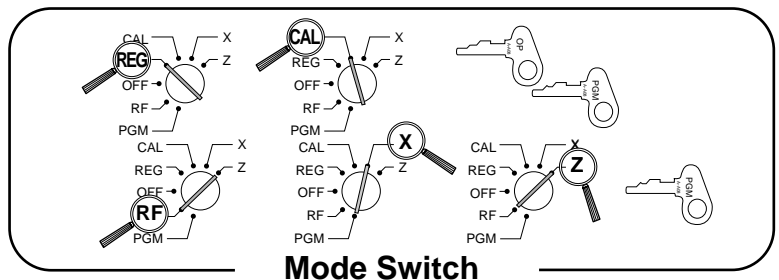

Clerk sign on

	OPERATION	RECEIPT
Signing clerk 1 on:	1 →	<div style="border: 1px solid black; padding: 5px; width: fit-content; margin: auto;"> <p>05-11-2000 12:10 REG C01 000123 — Mode/clerk name/consecutive No. DEPT01 \$1.00 DEPT02 \$2.00 DEPT03 \$1.00 DEPT03 \$3.00</p> </div>
Signing clerk 2 on:	2 →	
Signing clerk 25 on:	2 5 →	

Clerk sign off

	OPERATION
Signing clerk off:	0 →

- The current clerk is also signed off whenever you set the mode switch to OFF position.

Important!

- Once you select the clerk control function (page 51), the error code "E08" appears on the display whenever you try to perform a registration, a read/reset operation without signing on.
- You can choose either the clerk key function or the open key function.
- The signed on clerk is also identified on the receipt/journal.

About post-finalization receipt

You can issue a receipt even if the cash register is not in the receipt mode.

The post-finalization receipt lets you issue a receipt after finalization of the transaction.

Note that all of the following conditions must be satisfied.

- The option "print receipts" is selected.
- The receipt issuance status must be OFF.
- The transaction must be finalized in the REG or RF mode using the **CA/AMT = /TEND**, **CH** or **CHK** key.

Post-finalization receipt example

You can program the cash register to print the transaction total only (below Total format) or full details (below Detailed format) on the post-finalization receipt. Note that if the transaction contains more than 45 lines (including receipt header), the cash register prints in a Total format regardless of your programming.

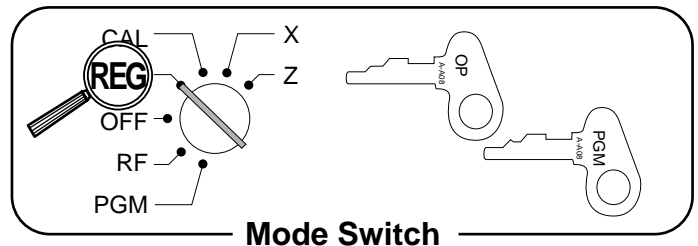

OPERATION

RECEIPT

Item 1	Unit price	\$10.00
	Quantity	1
	Dept.	1
	Taxable	1
Item 2	Unit price	\$20.00
	Quantity	1
	Dept.	2
	Taxable	2
Payment	Cash	\$32.50

1 0 00 49/73
+ 25
1
2 0 00 50/74
- 26
2
SUB
TOTAL
3 2 5 0 CA/AMT
= /TEND
POST
RECEIPT
/EXCHG

Receipt is not issued.

Post-finalization receipt is issued.

If "Automatic issue" is selected, no need to press **POST RECEIPT /EXCHG** key.

Total format

```
05-11-2000 12:35
REG                000123
CA                 $32.50
```

Detailed format

```
05-11-2000 12:35
REG                000123
DEPT01            1  $10.00
DEPT02            2  $20.00
TA1                $10.00
TX1                $0.50
TA2                $20.00
TX2                $2.00
TL                 $32.50
CA                 $32.50
CG                 $0.00
```

Important!

- You can issue only one post-finalization receipt per transaction.

Convenient Operations and Setups

Programming general printing control

Suppress printing of the subtotal line during tender operation.		No = 0 Yes = 1	<input type="checkbox"/> D ₈
Print the current time.	a	Yes = 0 No = 1	<input type="checkbox"/> (a+b+c) D ₇
Skip the date on journal.	b	Yes = 0 No = 2	
Skip the consecutive number.	c	Yes = 0 No = 4	
Print receipt/Print journal.	a	Receipt = 0 Journal = 1	<input type="checkbox"/> (a+b+c) D ₆
Issue post receipt by Finalize key (automatic issue)/ Post receipt key (manual issue)	b	Manual = 0 Automatic = 2	
Detail format/Total format in the post receipt	c	Detail = 0 Total = 4	
Print taxable amount.	a	Yes = 0 No = 1	<input type="checkbox"/> (a+b+c) D ₅
Print tax symbols.	b	Yes = 0 No = 2	
Print number of item sold.	c	No = 0 Yes = 4	
Skip item lines on journal. (JOURNAL SKIP)	a	No = 0 Yes = 1	<input type="checkbox"/> (a+b) D ₄
Print subtotal when the key is pressed.	b	No = 0 Yes = 2	
Digit delimiter symbol.	a	Period = 0 Comma = 1	<input type="checkbox"/> (a+b) D ₃
Decimal symbol.	b	Period = 0 Comma = 2	
Print hyphens before finalizing a transaction.	a	No = 0 Yes = 1	<input type="checkbox"/> (a+b) D ₂
Print logo message on receipt.	b	No = 0 Yes = 4	
Print commercial message on receipt.		No = 0 Yes = 2	<input type="checkbox"/> D ₁

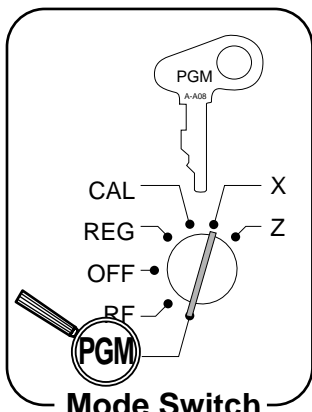

Mode Switch

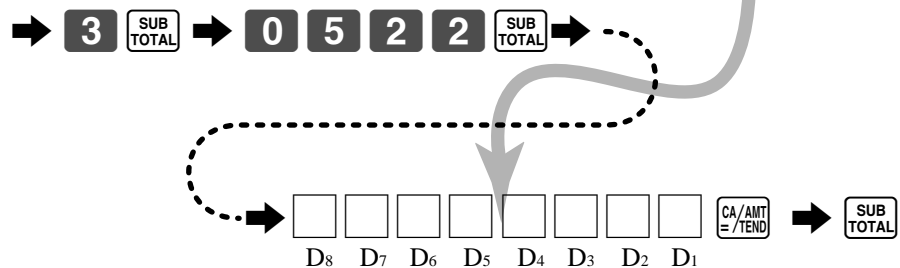

Note: After machine initialization, D₂ is set to "4" (Print logo message).

Programming compulsory and clerk control function

Force <input type="checkbox"/> SUB TOTAL operation before finalization.	a	No = 0 Yes = 2	<input type="checkbox"/> (a+b) D ₈
Force a money declaration before allowing a daily read/reset and financial read operation.	b	No = 0 Yes = 4	<input type="checkbox"/> D ₇
Always "0"			<input type="checkbox"/> D ₆
Always "0"			<input type="checkbox"/> D ₅
Clear the key buffer when a receipt is issued. (Effective only in REG mode)	a	No = 0 Yes = 1	<input type="checkbox"/> (a+b) D ₄
Perform auto sign-off when a receipt/report is issued. This is only effective the clerk code system is selected.	b	No = 0 Yes = 2	<input type="checkbox"/> D ₃
Display "seconds" during time display.		No = 0 Yes = 2	<input type="checkbox"/> D ₂
Reset the consecutive number when the daily reset report is issued.	a	Yes = 0 No = 1	<input type="checkbox"/> (a+b) D ₁
Prohibit cancel operation.	b	No = 0 Yes = 2	<input type="checkbox"/>
Assign <input type="checkbox"/> 00 as "00" or "000"	a	"00" = 0 "000" = 1	<input type="checkbox"/>
* Assign <input type="checkbox"/> OPEN/CLK# as "OPEN" or "CLK#" (clerk code system)	b	"OPEN" = 0 "CLK#" = 4	<input type="checkbox"/>

* In case of changing "CLK#" to "OPEN", issue all (daily, periodic-1 and periodic-2) reset report.

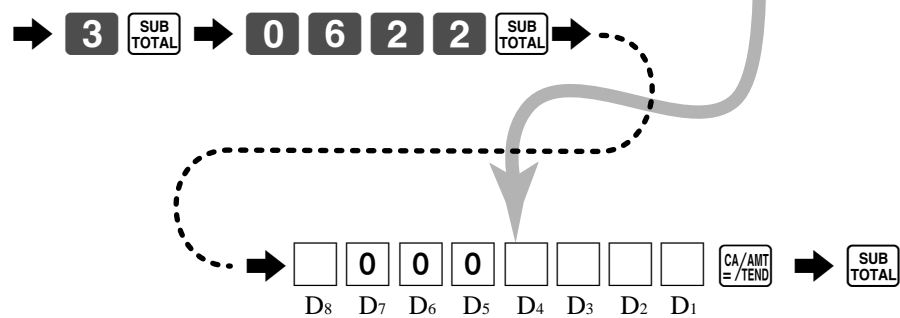
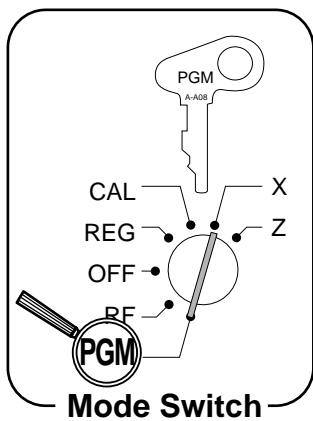

Convenient Operations and Setups

Programming read/reset report printing control

Print the first and the last consecutive number of the day (consecutive No. range) on the daily sales reset report.		Yes = 4 No = 0	<input type="checkbox"/> D ₆
Skip zero total lines on department and transaction read/reset report.	a	Yes = 0 No = 1	<input type="checkbox"/> (a+b+c) D ₅
Skip zero total lines on PLU read/reset report.	b	Yes = 0 No = 2	
Skip zero total lines on hourly sales report.	c	Yes = 0 No = 4	
Print the sales ratio on read/reset report.	a	No = 0 Yes = 1	<input type="checkbox"/> (a+b) D ₄
Suppress printing of the non-resettable grand total on the daily reset report.	b	No = 0 Yes = 2	<input type="checkbox"/> D ₃
Suppress printing of RF mode/RF key total and count on the read/reset report.		No = 0 Yes = 1	
Always "0"			<input type="text" value="0"/> <input type="text" value="0"/> D ₂ D ₁

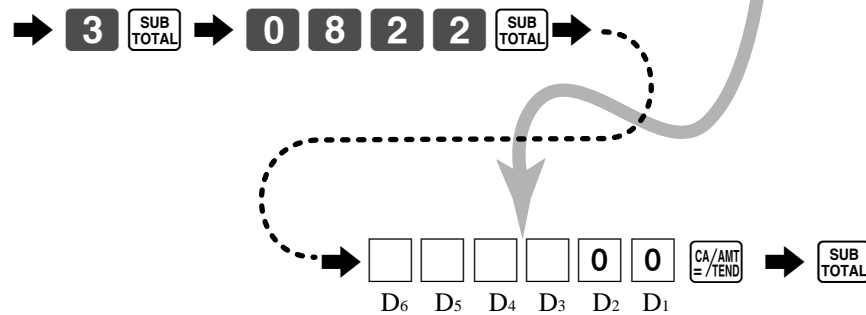
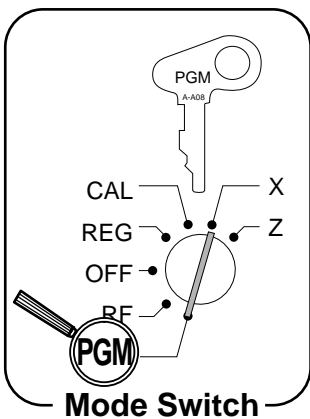

Setting a store/machine number

You can set a 4-digit machine number to identify your machine. The machine number is printed on receipts/journal for each transaction.

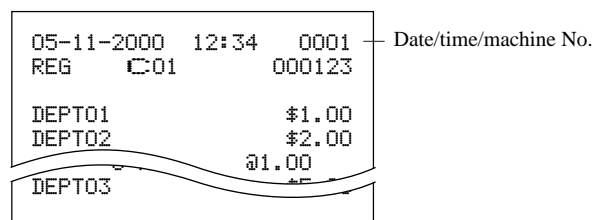
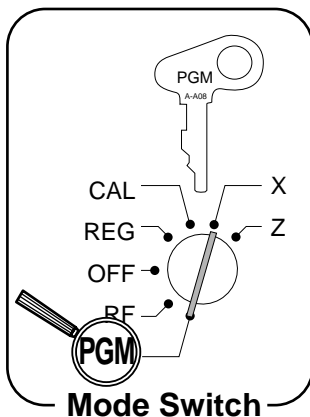

Programming to clerk

You can program up to 4-digit assigning number (clerk number), and trainee status of clerk (i.e. training cashier) for each clerk.

Important!

This program is required only when the  key is assigned as "CLK#" by the general function programming (code = 0622) on page 51.

Programming clerk number

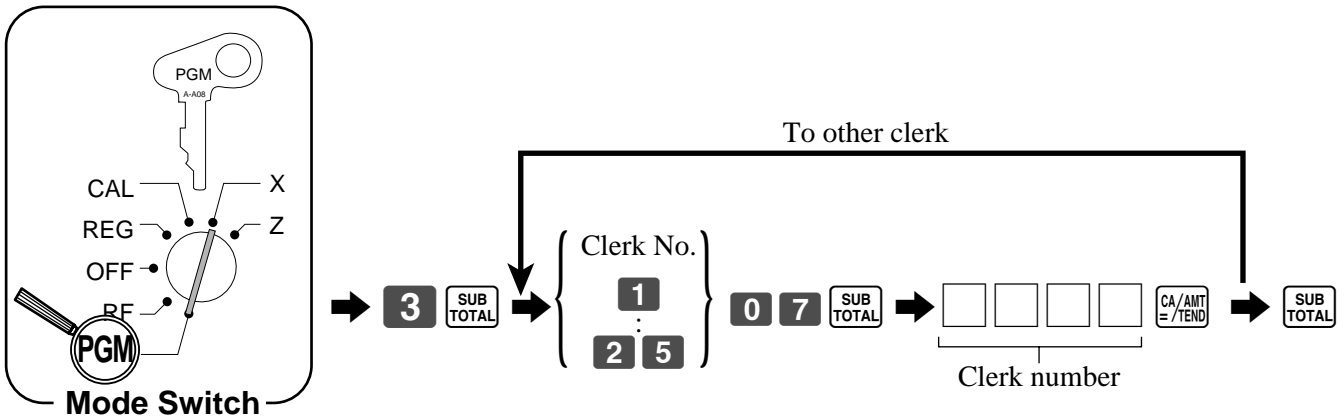

Programming trainee status of clerk

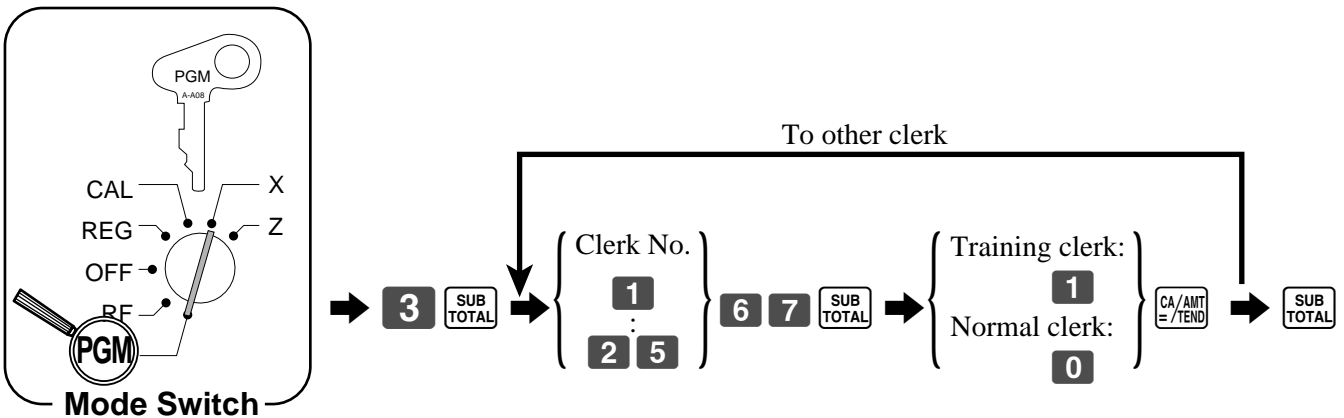

When a training clerk signs on, the cash register automatically enters the training mode. In the training mode, no operations are affected on any totalizers nor counters. The training mode symbols are printed in the columns of receipt entries produced in the training mode. The cash register exits the training mode when the training clerk signs off.

Convenient Operations and Setups

Programming descriptors and messages

The following descriptors and messages can be programmed;

- Report descriptor (such as gross total, net total, cash in drawer...)
- Grand total
- Special character (such as mode symbol, taxable symbol...)
- Read/reset report title
- Clerk name
- PLU item descriptor
- Messages (logo and commercial message)
- Function key descriptor
- Department key descriptor

Programming report descriptor, grand total, special character, report title, receipt message and clerk name

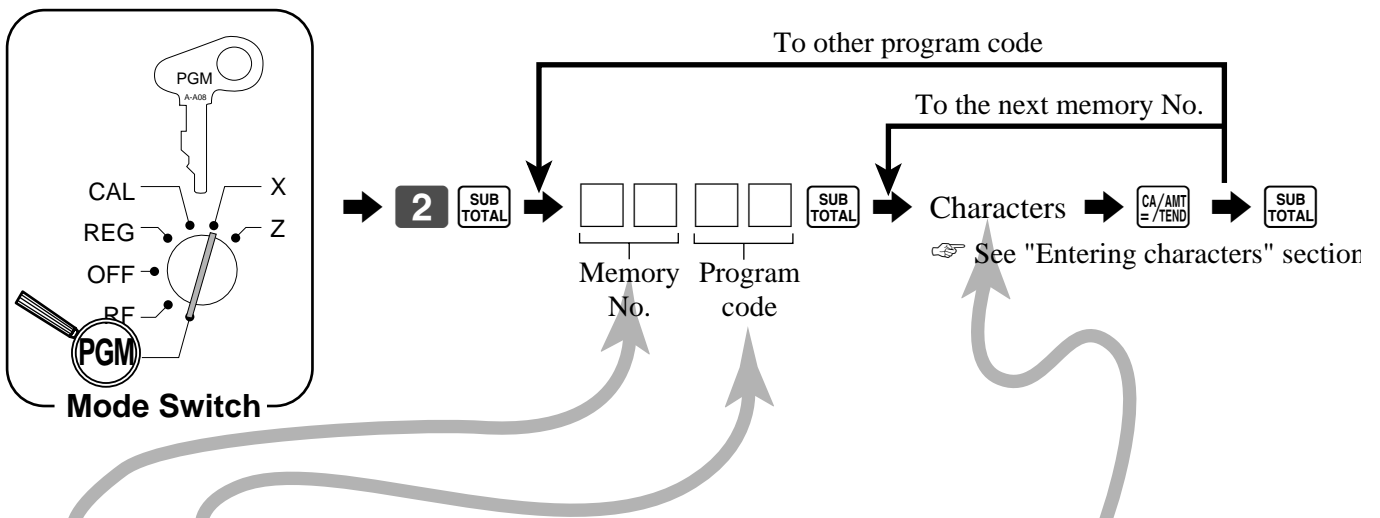

Memory No.	Program code	Contents	Initial character	Yours											
Report descriptor															
01	01	Gross total	GROSS												
02		Net total	NET												
03		Cash in drawer	CAID												
04		Charge in drawer	CHID												
05		Check in drawer	CKID												
06		Foreign currency cash in drawer	CECA												
07		Foreign currency check in drawer	CECK												
08		Taxable amount 1	TA1												
09		Tax 1	TX1												
10		Taxable amount 2	TA2												
11		Tax 2	TX2												
12		Taxable amount 3	TA3												
13		Tax 3	TX3												
14		Cancellation total	CANCEL												
15		Refund mode total	RF MODE												
16		Calculator mode count	CAL												
17		Non-link department total	NON-LINK_DEPT												

Memory No.	Program code	Contents	Initial character	Yours																				
Grand total																								
01	20	Grand total	GT																					
Special character																								
01	23	Amount/@/No./Quantity (2 ea.)	# @NoQT																					
02		Item count (2)	NoCT																					
03		Multiplication/Split pricing (2 ea.)	X /																					
04		Taxable status 1 ~ 3 (1 ea.)	T 1 2 3																					
05		All taxable status (1)	*																					
06		Foreign currency symbol (2 ea.)	* * * *																					
07		Reg mode/Refund mode (4 ea.)	REG RF																					
08		Program mode (4)	P n (n= 1 ~ 6)																					
09		X/Z mode (4 ea.)	X Z																					
11		Training mode	****																					
12		Training symbol	TRAINING																					
13		Total symbol (Tendering)	TL																					
14		Change symbol	CG																					
15		Total symbol (Post receipt)	TL																					
16		Total symbol (% registration)	ST																					
17		not used	SEND PGM																					
18		not used	RECV PGM																					
19		not used	PGM																					
20		not used	END																					
21		not used	ERROR																					
22		not used	**END**																					
24		Total message on report	TOTAL																					
Report title																								
01		24	Daily report title	DAILY																				
02	PLU report title		PLU																					
03	Hourly sales report title		HOURLY																					
04	Group report title		GROUP																					
05	Clerk report title		CLERK																					
06	Financial report title		FLASH																					
07	Monthly report title		MONTHLY																					
08	Periodic-1 report title		PERIODIC-1																					
09	Periodic-2 report title		PERIODIC-2																					
10	Individual report title																							

Convenient Operations and Setups

Memory No.	Program code	Contents	Initial character	Yours									
Receipt message													
01	32	1st line of logo message											
02		2nd line of logo message	YOUR RECEIPT										
03		3rd line of logo message	THANK YOU										
04		4th line of logo message	CALL AGAIN										
05		5th line of logo message											
06		1st line of commercial message											
07		2nd line of commercial message											
08		3rd line of commercial message											
09		4th line of commercial message											
10		5th line of commercial message											

Memory No.	Program code	Contents	Initial character	Yours									
Clerk													
01	07	Clerk 01	C01										
02		Clerk 02	C02										
03		Clerk 03	C03										
04		Clerk 04	C04										
05		Clerk 05	C05										
06		Clerk 06	C06										
07		Clerk 07	C07										
08		Clerk 08	C08										
09		Clerk 09	C09										
10		Clerk 10	C10										
11		Clerk 11	C11										
12		Clerk 12	C12										
13		Clerk 13	C13										
14		Clerk 14	C14										
15		Clerk 15	C15										
16		Clerk 16	C16										
17		Clerk 17	C17										
18		Clerk 18	C18										
19		Clerk 19	C19										
20		Clerk 20	C20										
21		Clerk 21	C21										
22		Clerk 22	C22										
23		Clerk 23	C23										
24		Clerk 24	C24										
25		Clerk 25	C25										

Programming department key descriptor

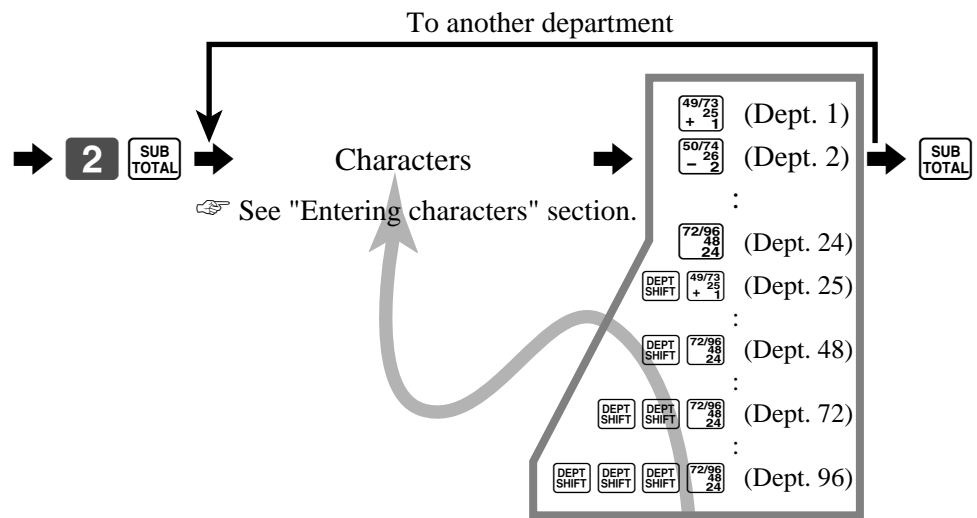
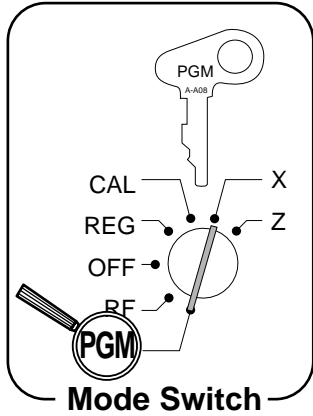

Contents	Initial character	Yours			
Department key					
Department 01	DEPT01				
Department 02	DEPT02				
Department 03	DEPT03				
Department 04	DEPT04				
Department 05	DEPT05				
Department 06	DEPT06				
Department 07	DEPT07				
Department 08	DEPT08				
Department 09	DEPT09				
Department 10	DEPT10				
Department 11	DEPT11				
Department 12	DEPT12				
Department 13	DEPT13				
Department 14	DEPT14				
Department 15	DEPT15				
Department 16	DEPT16				
Department 17	DEPT17				
Department 18	DEPT18				
Department 19	DEPT19				
Department 20	DEPT20				
Department 21	DEPT21				
Department 22	DEPT22				
Department 23	DEPT23				
Department 24	DEPT24				
Department 25	DEPT25				
Department 26	DEPT26				
Department 27	DEPT27				
Department 94	DEPT94				
Department 95	DEPT95				
Department 96	DEPT96				

Convenient Operations and Setups

Programming PLU descriptor

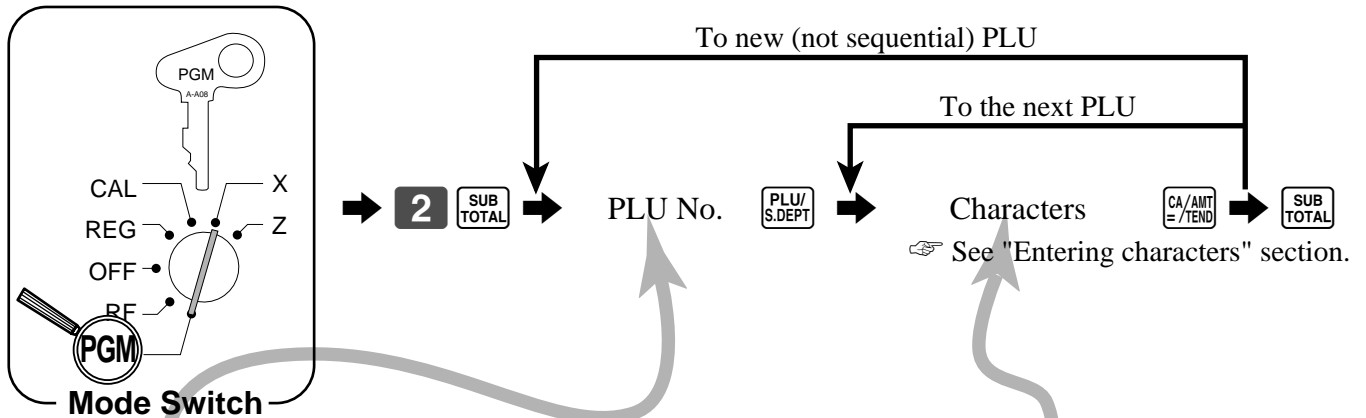

PLU No.	Contents	Initial character	Yours			
PLU						
001	PLU 001	PLU001				
002	PLU 002	PLU002				
003	PLU 003	PLU003				
004	PLU 004	PLU004				
005	PLU 005	PLU005				
006	PLU 006	PLU006				
007	PLU 007	PLU007				
008	PLU 008	PLU008				
009	PLU 009	PLU009				
010	PLU 010	PLU010				
011	PLU 011	PLU011				
012	PLU 012	PLU012				
013	PLU 013	PLU013				
014	PLU 014	PLU014				
015	PLU 015	PLU015				
016	PLU 016	PLU016				
017	PLU 017	PLU017				
018	PLU 018	PLU018				
019	PLU 019	PLU019				
020	PLU 020	PLU020				
021	PLU 021	PLU021				
022	PLU 022	PLU022				
023	PLU 023	PLU023				
024	PLU 024	PLU024				
025	PLU 025	PLU025				
026	PLU 026	PLU026				
027	PLU 027	PLU027				
028	PLU 028	PLU028				
029	PLU 029	PLU029				
598	PLU 598	PLU598				
599	PLU 599	PLU599				
600	PLU 600	PLU600				

Programming function key descriptor

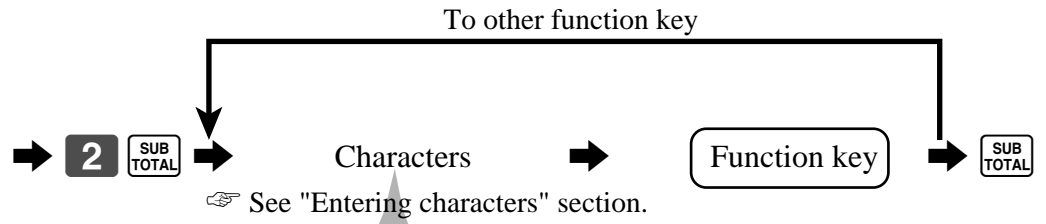
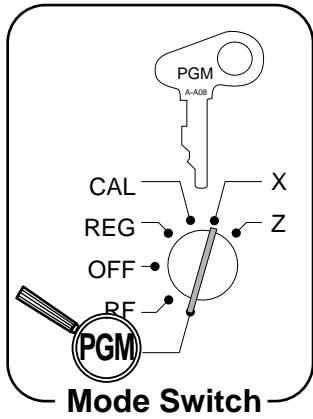

Contents	Initial character	Yours					
Function							
Cash/amount tendered	CA						
Charge	CH						
Check	CHK						
Received on account/Tax shift 1	RC						
Paid out/Tax shift 2	PD						
Minus	-						
Percent	%						
Refund	RF						
Error correct/Cancel	CORR						
Post receipt/Currency exchange	CE						
Non-add/No sale	#/NS						

Convenient Operations and Setups

Entering characters

In this section, the method to enter descriptors or messages (characters) to the cash register during programming is described.

Characters are specified by character keyboard or by codes. In the first half of this section, the usage of character keyboard is described. In the latter half, inputting method by character code is described.

Using character keyboard

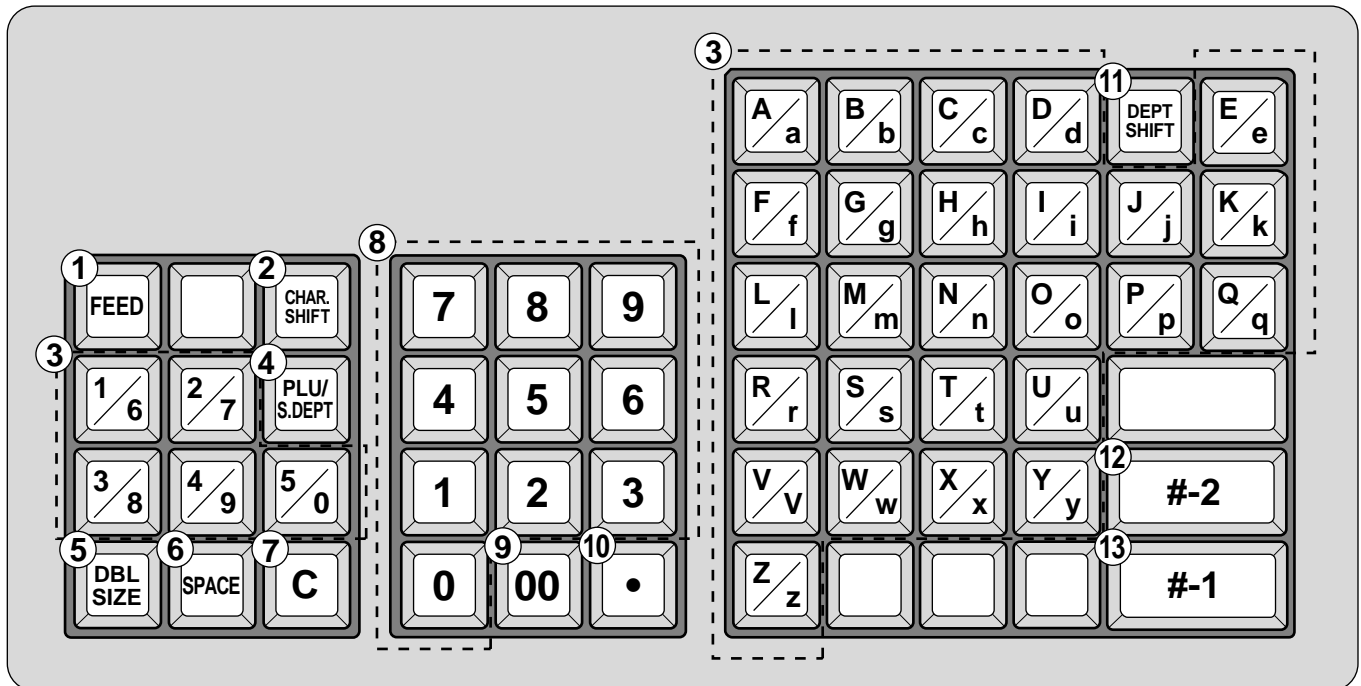

- ① **Feed key**
Hold this key down to feed paper from the printer.
- ② **Character shift key**
Pressing this key shifts the character from the uppercase letter to lower case letter and returns to the uppercase letter in sequence.
- ③ **Alphabet keys**
Used input to characters.
- ④ **PLU/Subdepartment key**
Use this key to input PLU/Subdepartment numbers.
- ⑤ **Double size letter key**
Specifies that the next character you input to a double size character. You must press this key before each double size character.
- ⑥ **Space key**
Set a space by depression.
- ⑦ **Clear key**
Clears all input characters in the programming.
- ⑧ **Numeric keys**
Used to enter program codes, memory number and character codes.
- ⑨ **Character fixed key**
Enter when the alphabetic entry for a descriptor, name or message has been completed.
- ⑩ **Backspace/Character code fixed key**
Registers one character with code (2 or 3 digit). Clears the last input character, much like a back space key.
- ⑪ **Department shift key**
Use this key to shift the department key number from 1 through 24 to 25 through 48, 49 through 72 or 73 through 96.
- ⑫ **Program end key**
Terminates the character programming.
- ⑬ **Character enter key**
Registers the programmed characters.

Example:

Input "APPLE Juice",

enter "DBL SIZE", "A", "SHIFT", "p", "p", "l", "e", "SPACE", "SHIFT", "J", "SHIFT", "u", "i", "c", "e" **00**.

Entering characters by code

Characters are specified by codes. Every time you enter a character, choose character codes by the character code list (below) and press the  key to settle it. After completion of entering characters, press the **00** key to fix them.

Example: Input "Apple Juice", enter "255  65  112  112  108  101  32  74  117  105  99  101 **00**."

Character code list

Space	32	0	48	@	64	P	80	ı	96	Ɔ	112	Ç	128
!	33	1	49	A	65	Q	81	a	97	Ɔ	113	Ü	129
€	34	2	50	B	66	R	82	b	98	Ɔ	114	é	130
#	35	3	51	C	67	S	83	c	99	Ɔ	115	â	131
\$	36	4	52	D	68	T	84	d	100	Ɔ	116	ä	132
%	37	5	53	E	69	U	85	e	101	u	117	à	133
&	38	6	54	F	70	V	86	f	102	v	118	á	134
'	39	7	55	G	71	W	87	g	103	w	119	ç	135
(40	8	56	H	72	X	88	h	104	x	120	è	136
)	41	9	57	I	73	Y	89	i	105	y	121	ë	137
*	42	:	58	J	74	Z	90	j	106	z	122	ê	138
+	43	;	59	K	75	ı	91	k	107	I	123	ï	139
,	44	<	60	L	76	¥	92	l	108	II	124	î	140
-	45	.	61	M	77	ı	93	m	109	III	125	ı	141
.	46	>	62	N	78	ı	94	n	110	ıı	126	ä	142
/	47	?	63	O	79	ı	95	o	111	ıı	127	å	143
É	144	á	160	ı	176	ā	192	k	208	À	224	Ɔ	240
æ	145	ı	161	ı	177	č	193	ı	209	é	225	ú	241
Æ	146	ó	162	ı	178	ē	194	o	210	ı	226	û	242
ô	147	ú	163	ı	179	ö	195	š	211	ó	227	π	243
ö	148	ı	164	ā	180	ı	196	ü	212	ö	228	ε	244
ò	149	ı	165	ā	181	K	197	ž	213	ü	229	Σ	245
ó	150	ı	166	ā	182	L	198	Ř	214	ü	230	φ	246
ù	151	ē	167	ō	183	N	199	E	215	á	231	ψ	247
ú	152	č	168	ō	184	š	200	é	216	é	232	o	248
ö	153	ē	169	ō	185	ü	201	I	217	ı	233	θ	249
ü	154	ē	170	ò	186	ž	202	U	218	ó	234	ϛ	250
ø	155	ı	171	ó	187	đ	203	a	219	ö	235	⋮	251
ı	156	ı	172	ú	188	č	204	ę	220	ú	236		252
ı	157	ı	173	ú	189	ē	205	è	221	ú	237		253
ı	158	+	174	"	190	š	206	ı	222	((238		254
ı	159	+	175	_	191	ı	207	ı	223)	239	Double size	255

Convenient Operations and Setups

Department key feature programming

There are two different methods you can use to assign features to department keys. With "Batch feature programming", you can use a single operation to assign multiple features. "Individual feature programming", on the other hand, let you assign features one-by-one. This method is recommended for programming of special features to individual department keys.

Batch feature programming

When using this procedure to assign multiple features to departments, use 9-digit codes that you create using the following procedure.

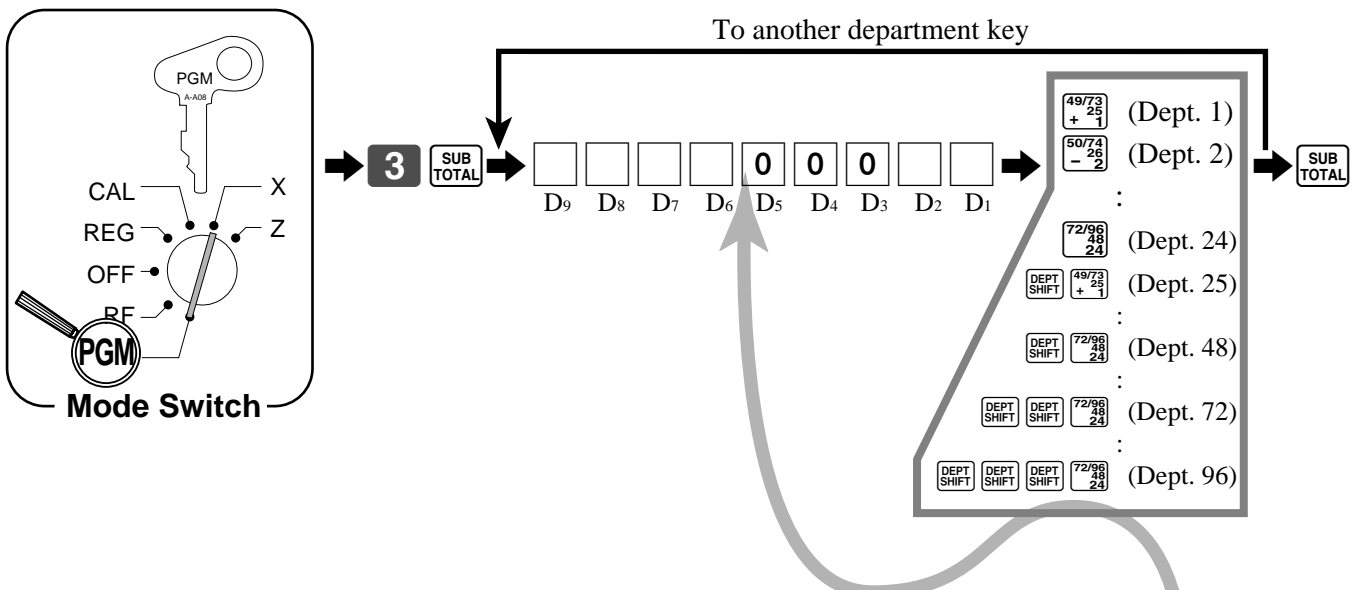

Negative department	No = 0 Yes = 2	<input type="checkbox"/> D ₉
Single item sale	No = 0 Yes = 1	<input type="checkbox"/> D ₈
High digit limit specification	Significant number	<input type="checkbox"/> D ₇
Taxable status 1	a No = 0 Yes = 1	<input type="checkbox"/> (a+b+c) D ₆
Taxable status 2	b No = 0 Yes = 2	
Taxable status 3	c No = 0 Yes = 4	
Always "000"		<input type="checkbox"/> <input type="checkbox"/> <input type="checkbox"/> D ₅ D ₄ D ₃
Group link (00 ~ 50)	Significant number	<input type="checkbox"/> <input type="checkbox"/> D ₂ D ₁
	Significant number	

Note: If you require tax table 3, please refer to page 39.

Individual feature programming

With this procedure, you can assign individual features to specific departments. Please select the command code of the contents you want to program, and follow the procedure below.

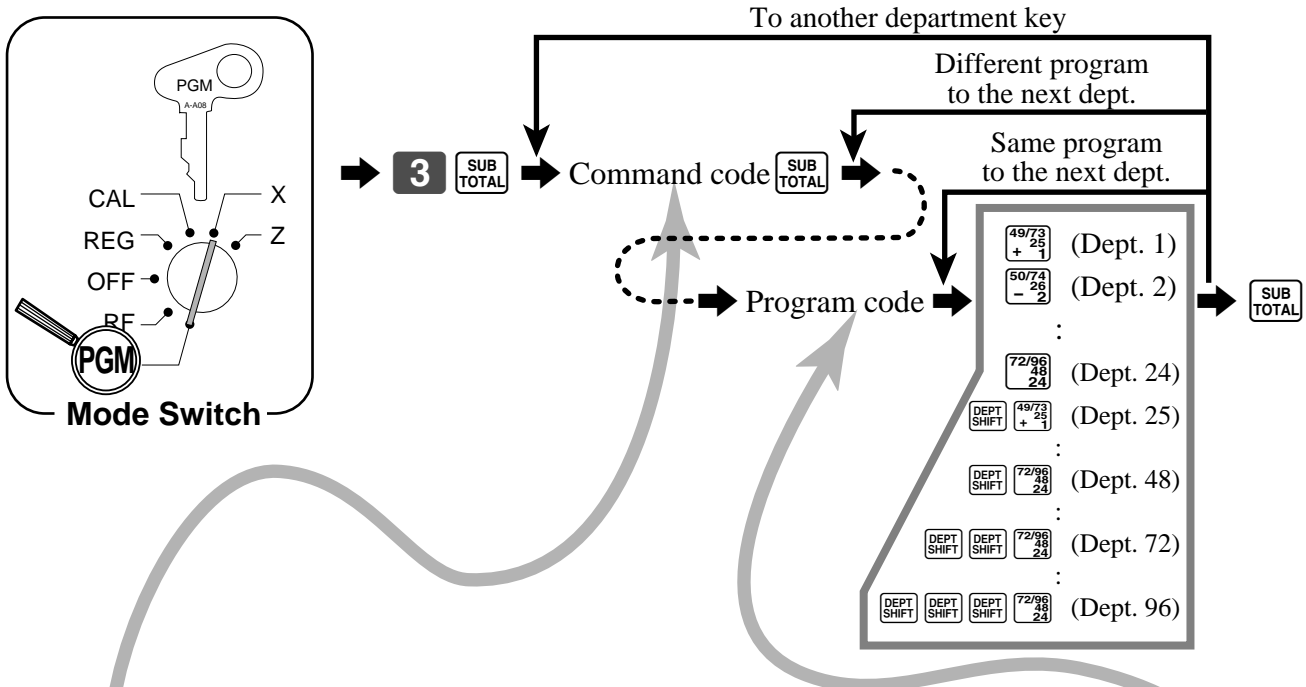

Command code	Contents/selection			Program code	
0166	Negative department			No = 0 Yes = 2	<input type="checkbox"/>
1866	Single item sale			No = 0 Yes = 1	<input type="checkbox"/>
1566	High digit limit specification			Significant number	<input type="checkbox"/>
0366	Taxable status 1	a	No = 0 Yes = 1	<input type="checkbox"/> (a+b+c)	
	Taxable status 2	b	No = 0 Yes = 2		
	Taxable status 3	c	No = 0 Yes = 4		
1166	Group link (00 ~ 50)			Significant number	<input type="checkbox"/>
				Significant number	

To program a unit price to a department key, please refer to the page 29.

Convenient Operations and Setups

PLU feature programming

There are two different methods you can use to assign features to PLUs. With "Batch feature programming", you can use a single operation to assign multiple features.

"Individual feature programming", on the other hand, let you assign features one-by-one. This method is recommended for programming of special features to individual PLUs.

Batch feature programming

When using this procedure to assign multiple features to PLUs, use 9-digit codes that you create using the following procedure.

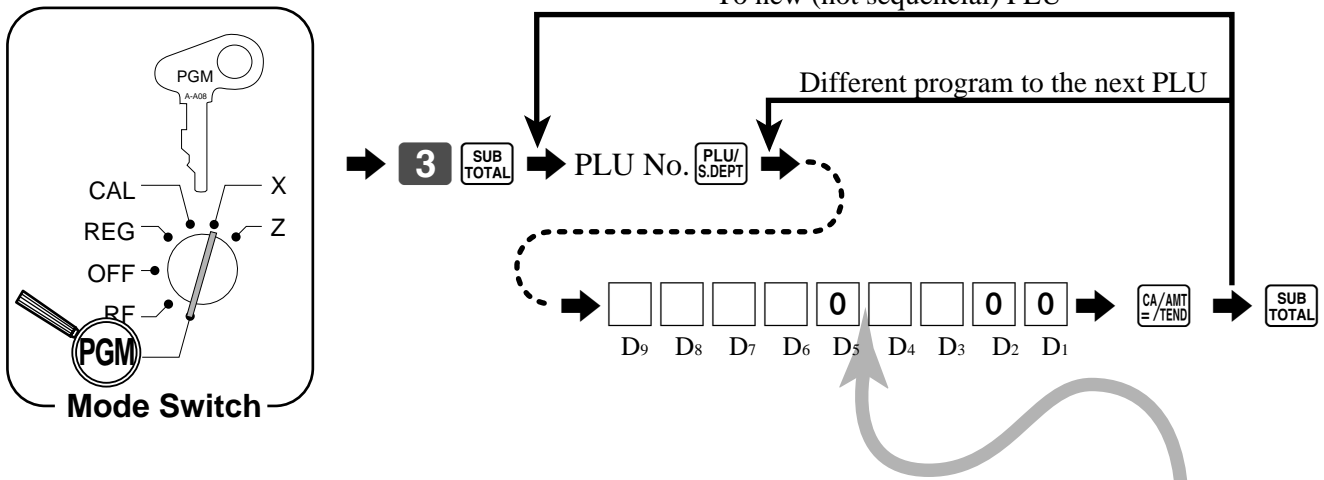

Negative PLU		No = 0 Yes = 2	<input type="checkbox"/> D ₉
Single item sale	a	No = 0 Yes = 1	<input type="checkbox"/>
Treat as subdepartment/PLU.	b	PLU = 0 Subdept. = 4	(a+b) D ₈
High digit limit specification (for subdepartment)		Significant number	<input type="checkbox"/> D ₇
Taxable status 1	a	No = 0 Yes = 1	<input type="checkbox"/> (a+b+c) D ₆
Taxable status 2	b	No = 0 Yes = 2	
Taxable status 3	c	No = 0 Yes = 4	
Always "0"			<input type="text" value="0"/> D ₅
Department link (00 ~ 96)		Significant number	<input type="text"/> D ₄ D ₃
		Significant number	
Always "00"			<input type="text" value="0"/> D ₂ D ₁

Note: If you require tax table 3, please refer to page 39.

Individual feature programming

With this procedure, you can assign individual features to specific PLUs. Please select the command code of the contents you want to program, and follow the procedure below.

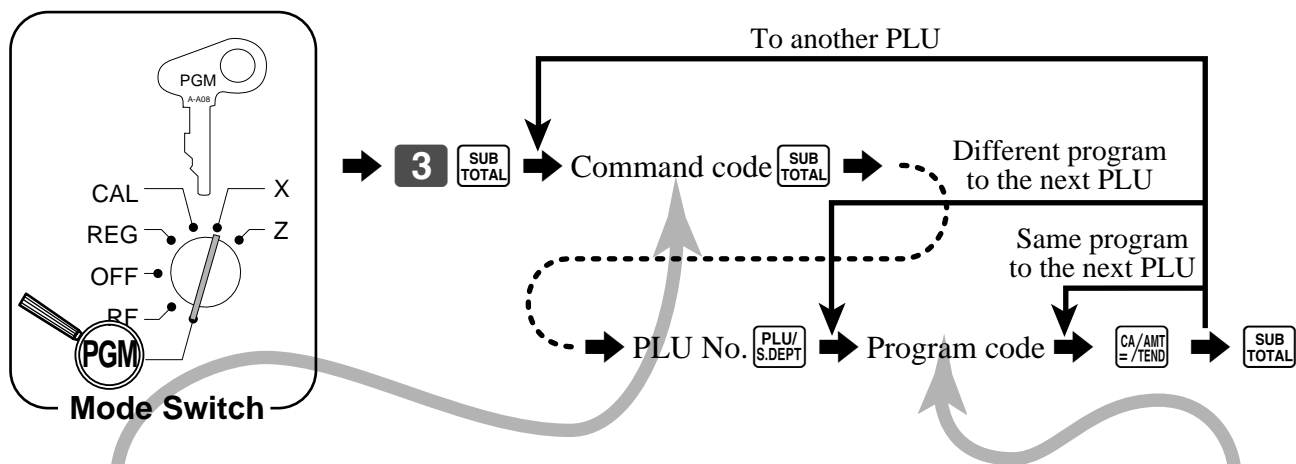

Command code	Contents/selection			Program code
0166	Negative PLU			No = 0 Yes = 2 <input type="checkbox"/>
1866	Single item sale	a	No = 0 Yes = 1	<input type="checkbox"/> (a+b)
	Treat as subdepartment/PLU.	b	PLU = 0 Subdept. = 4	
1566	High digit limit specification (for subdepartment)			Significant number <input type="checkbox"/>
0366	Taxable status 1	a	No = 0 Yes = 1	<input type="checkbox"/> (a+b+c)
	Taxable status 2	b	No = 0 Yes = 2	
	Taxable status 3	c	No = 0 Yes = 4	
1166	Department link (00 ~ 96)			Significant number
				Significant number
				<input type="text"/> <input type="text"/> 0 0

To program a unit price to a PLU or a subdepartment, please refer to the page 31.

Convenient Operations and Setups

Registering example

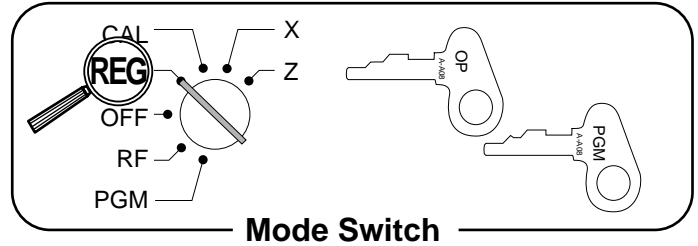

Locking out and releasing high digit limitation

	OPERATION	RECEIPT														
<table border="1" style="width: 100%; border-collapse: collapse;"> <tr> <td rowspan="5" style="text-align: center; vertical-align: middle;">Item</td> <td>Unit price</td> <td style="text-align: right;">\$10.50</td> </tr> <tr> <td>Quantity</td> <td style="text-align: center;">1</td> </tr> <tr> <td>Dept.</td> <td style="text-align: center;">3</td> </tr> <tr> <td>Taxable</td> <td style="text-align: center;">(1)_{preset}</td> </tr> <tr> <td>Max.digit</td> <td style="text-align: center;">(3)_{preset}</td> </tr> <tr> <td>Payment</td> <td>Cash</td> <td style="text-align: right;">\$20.00</td> </tr> </table>	Item	Unit price	\$10.50	Quantity	1	Dept.	3	Taxable	(1) _{preset}	Max.digit	(3) _{preset}	Payment	Cash	\$20.00	<div style="display: flex; justify-content: space-around; font-size: 24px; font-weight: bold;">1 0 5 0</div> <div style="display: flex; justify-content: space-between; font-size: 10px;"> 51/75 x 27 3 CAL </div> <p>ERROR ALARM (Exceeding max. digits)</p> <div style="display: flex; justify-content: space-around; font-size: 18px; font-weight: bold;">C</div> <div style="display: flex; justify-content: space-around; font-size: 10px;"> OPEN CLK# PGM </div> <p>Cancels limitations for next entry</p> <div style="display: flex; justify-content: space-around; font-size: 24px; font-weight: bold;">1 0 5 0</div> <div style="display: flex; justify-content: space-between; font-size: 10px;"> 51/75 x 27 3 CAL </div> <div style="display: flex; justify-content: space-around; font-size: 12px; font-weight: bold;">SUB TOTAL</div> <div style="display: flex; justify-content: space-around; font-size: 24px; font-weight: bold;">2 0 00</div> <div style="display: flex; justify-content: space-between; font-size: 10px;"> CA/AMT = /TEND PGM </div>	<pre style="font-family: monospace; font-size: 12px;"> 05-11-2000 12:40 0001 REG 000050 DEPT01 1 \$10.50 TA1 \$10.50 TX1 \$0.53 TL \$11.03 CA \$20.00 CG \$8.97 </pre>
Item		Unit price	\$10.50													
		Quantity	1													
		Dept.	3													
		Taxable	(1) _{preset}													
	Max.digit	(3) _{preset}														
Payment	Cash	\$20.00														

Single item sales items

You can issue a receipt by simply touching the single item sales department or PLU. The following examples show how you register single-item-sale departments. Registration of single item sale PLUs is identical.

Single item

	OPERATION	RECEIPT											
<table border="1" style="width: 100%; border-collapse: collapse;"> <tr> <td rowspan="5" style="text-align: center; vertical-align: middle;">Item</td> <td>Unit price</td> <td style="text-align: right;">\$2.00</td> </tr> <tr> <td>Quantity</td> <td style="text-align: center;">1</td> </tr> <tr> <td>Dept.</td> <td style="text-align: center;">4</td> </tr> <tr> <td>Taxable</td> <td style="text-align: center;">2</td> </tr> <tr> <td>Sales status</td> <td style="text-align: center;">Single item</td> </tr> </table>	Item	Unit price	\$2.00	Quantity	1	Dept.	4	Taxable	2	Sales status	Single item	<div style="display: flex; justify-content: space-around; font-size: 24px; font-weight: bold;">2 00</div> <div style="display: flex; justify-content: space-between; font-size: 10px;"> 52/76 + 28 4 CAL </div>	<pre style="font-family: monospace; font-size: 12px;"> 05-11-2000 12:45 0001 REG C01 000051 DEPT04 1 \$2.00 TA2 \$2.00 TX2 \$0.20 CA \$2.20 </pre>
Item		Unit price	\$2.00										
		Quantity	1										
		Dept.	4										
		Taxable	2										
	Sales status	Single item											

Multiple item sale

OPERATION

RECEIPT

Item 1	Unit price	\$2.00
	Quantity	1
	Dept.	3
	Taxable	2
	Sales status	Normal
Item 2	Unit price	\$5.00
	Quantity	1
	Dept.	4
	Taxable	2
	Sales status	Single item
Payment	Cash	\$7.70

2 00 51/29
× 3

5 00 52/76
+ 28
4

Single item status is not effective during transaction.

CA/AMT
=/TEND

It is necessary to press the finalize key.

05-11-2000	12:50	0001
REG	C01	000052
DEPT03	½	\$2.00
DEPT04	½	\$5.00
TA2		\$7.00
TX2		\$0.70
CA		\$7.70

Note: The single item sales department or PLU should be registered at the top of the transaction, otherwise the transaction is not finalized. It is necessary to press CA/AMT
=/TEND, CH or CHK key.

Examples of registering subdepartments

Single item sale

OPERATION

RECEIPT

Item	Unit price	\$6.00
	Quantity	1
	Subdept.	15
	Taxable	(1) _{preset}
Payment	Cash	\$10.00

1 5 PLU/
S.DEPT

PLU (subdepartment)
code

6 00 PRICE

Unit price

SUB
TOTAL

1 0 00 CA/AMT
=/TEND

05-11-2000	12:55	0001
REG	C01	000053
PLU015	½	\$6.00
TA1		\$6.00
TX1		\$0.30
TL		\$6.30
CA		\$10.00
CG		\$3.70

Convenient Operations and Setups

Repeat

Item 1	Unit price	(\$3.00) _{preset}
	Quantity	3
	Subdept.	15
	Taxable	(1) _{preset}
Item 2	Unit price	\$2.00
	Quantity	2
	Subdept.	15
	Taxable	(1) _{preset}
Payment	Cash	\$20.00

OPERATION

1 5

 Hit without a unit price recalls preset price.

1 5
2 00

2 0 00

RECEIPT

```

05-11-2000 13:00 0001
REG C:01 000054

PLU015 T $3.00
PLU015 T $3.00
PLU015 T $3.00
PLU015 T $2.00
PLU015 T $2.00
TA1 $13.00
TX1 $0.65
TL $13.65
CA $20.00
CG $6.35
    
```

Multiplication

Item	Unit Price	\$6.00
	Quantity	1.25
	Subdept.	15
	Taxable	(1) _{preset}
Payment	Cash	\$10.00

OPERATION

1 . 2 5
 Quantity (4-digit integer/2-digit decimal)
1 5
6 00

1 0 00

RECEIPT

```

05-11-2000 13:05 0001
REG C:01 000055

1.25 X @6.00
PLU015 T $7.50
TA1 $7.50
TX1 $0.38
TL $7.88
CA $10.00
CG $2.12
    
```

Split sales of packaged item

Item	Unit Price	12 for \$30.00
	Quantity	7
	Subdept.	37
	Taxable	(1) _{preset}
Payment	Cash	\$20.00

OPERATION

7
 Quantity being purchased (4-digit integer/2-digit decimal)
1 2
 Package quantity (4-digit integer/2-digit decimal)
3 7
3 0 00

2 0 00

RECEIPT

```

05-11-2000 13:10 0001
REG C:01 000056

7 X @12 / 30.00
PLU037 T $17.50
TA1 $17.50
TX1 $0.88
TL $18.38
CA $20.00
CG $1.62
    
```

Percent key feature programming

You can use the [%] key as discount key, premium key or manual tax key. In this section, detail information of [%] key is described.

Programming to the [%] key

To program a discount/premium rate, please refer to the page 34.

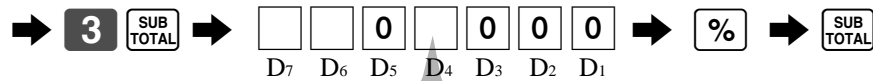
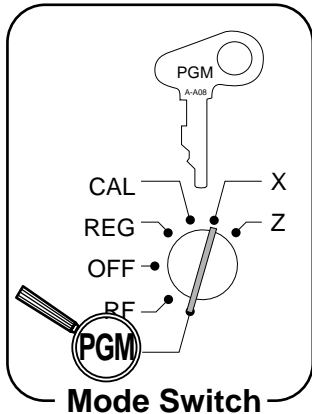

[%]			
Fraction control, round off = 0, cut off = 1, round up = 2 (only for %-/%+)		Significant number	<input type="checkbox"/> D ₇
Key attribution	a	%- = 0 %+ = 1 M-tax = 4	<input type="checkbox"/> (a+b) D ₆
Prohibit manual entry to override programmed percentage (only for %-/%+)	b	No = 0 Yes = 2	<input type="checkbox"/> D ₅
Always "0"			<input type="checkbox"/> D ₃
Taxable status 1 (only for %-/%+)	a	No = 0 Yes = 1	<input type="checkbox"/> (a+b+c) D ₄
Taxable status 2 (only for %-/%+)	b	No = 0 Yes = 2	
Taxable status 3 (only for %-/%+)	c	No = 0 Yes = 4	
Always "0"			<input type="checkbox"/> D ₂
Always "0"			<input type="checkbox"/> D ₁

Note: If you require tax table 3, please refer to page 39.

Convenient Operations and Setups

Registering discounts and premiums

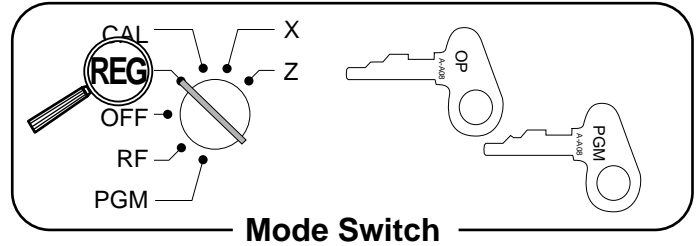

Discount for Items and subtotals



Refer to "Preparing and using discounts" in "Basic Operations and Setups" on page 34.



Premium for Items and subtotals

OPERATION

RECEIPT

Item 1	Unit price	(\$10.00) _{preset}
	Quantity	1
	Dept.	4
	Taxable	(2) _{preset}
Premium	Rate	7%
Item 2	Unit price	(\$5.00) _{preset}
	Quantity	1
	PLU	32
	Taxable	(2) _{preset}
Subtotal premium	Rate	(5%) _{preset}
	Taxable	(1 and 2) _{preset}
Payment	Cash	\$20.00



 Applies the input value as a premium rate (7%).



 For this operation, press this key instead of .



 Applies the preset premium rate (5%) to the subtotal.



05-11-2000	13:15	0001
REG	C-01	000057
DEPT04	7%	\$10.00
%+		\$0.70
PLU032		\$5.00
ST	5%	\$15.70
%+		\$0.79
TA2		\$16.49
TX2		\$1.65
TL		\$18.14
CA		\$20.00
CG		\$1.86

- You can manually input rates up to 4 digits long (0.01% to 99.99%).

Taxable status of the key

- Whenever you perform a discount/premium operation on the last item registered, the tax calculation for discount/premium amount is performed in accordance with the tax status programmed for that item.
- Whenever you perform a discount/premium operation on a subtotal amount, the tax calculation for the subtotal amount is performed in accordance with the tax status programmed for the  key.

Registering manual tax

You can program the cash register to change the function of the [%] key to that of a [M-TAX] (manual tax) key. The [M-TAX] key is used to register manually entered tax amounts.

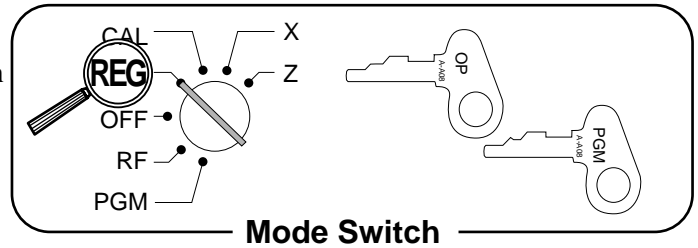

Mode Switch

Important!

If you program the cash register to perform registrations with manually entered tax amounts, the [M-TAX] key replaces the [%] key, so discount/premium registration will be impossible.

Also, please set the appropriate key descriptor to the key.

Example

OPERATION

RECEIPT

Item 1	Unit price	\$10.00
	Quantity	1
	Dept.	1
	Taxable	No
	M-Tax	Normal
Item 2	Unit price	\$20.00
	Quantity	1
	Dept.	2
	Taxable	2
Payment	Cash	\$33.00

1 0 00 49/73
+ 1
5 0 M-TAX
 [%] key is assigned
 to [M-TAX] key.
2 0 00 50/74
- 2
SUB
TOTAL
3 3 00 CA/AMT
=/TEND

```

05-11-2000 13:20 0001
REG C-01 000058

DEPT01 $10.00
M-TAX $0.50
DEPT02 ½ $20.00
TA2 $20.00
TX2 $2.00
TL $32.50
CA $33.00
CG $0.50
    
```

Convenient Operations and Setups

Currency exchange programming

When the **POST RECEIPT /EXCHG** key is pressed, a current subtotal including tax is converted directly into foreign currency and the result is displayed, and the subsequent finalization is handled using the foreign currency. The currency exchange function is released by finalizing a transaction, partial tender operation, receipt issuance, or by pressing the **SUB TOTAL** key.

Currency exchange rate programming

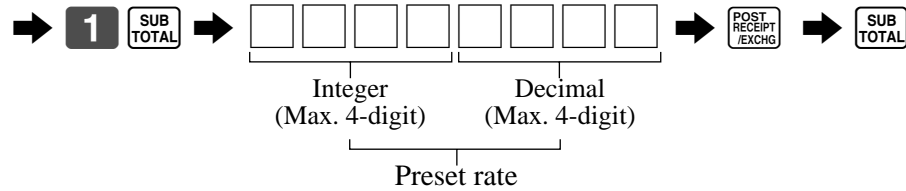
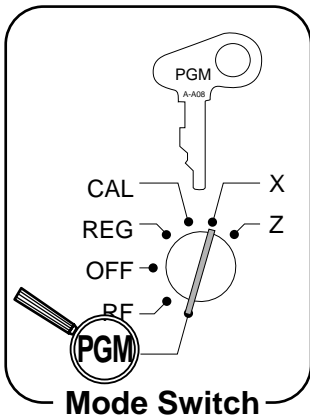

Example:

\$1.00 = ¥110.50 ⇨ **1** · **105**
 ¥100 = \$0.9050 ⇨ **0** · **905**

Currency exchange feature programming

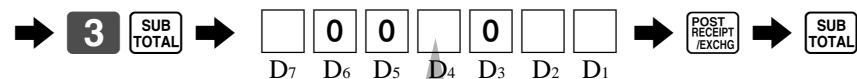
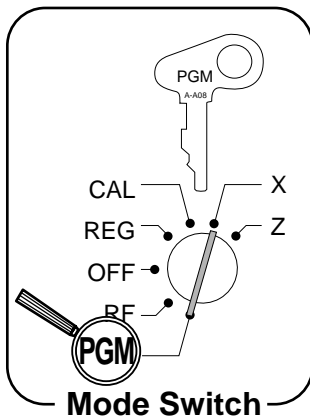

Fraction control, round off = 0, cut off = 1, round up = 2	Significant number	<input type="text"/> D ₇
Always "0"		<input type="text"/> <input type="text"/> D ₆ D ₅
Monetary symbol for foreign currency; Local currency symbol = 0 Monetary symbol 1 (in the special character program) = 1 Monetary symbol 2 (in the special character program) = 2 Monetary symbol 3 (in the special character program) = 3 Monetary symbol 4 (in the special character program) = 4	Significant number	<input type="text"/> D ₄
Always "0"		<input type="text"/> D ₃
Digit delimiter for foreign currency; Period = 0, Comma = 2	Significant number	<input type="text"/> D ₂
Monetary system code (decimal places) following currency exchange operation; Same as local currency = 0, <input type="text"/> <input type="text"/> = 1, <input type="text"/> <input type="text"/> <input type="text"/> = 2, <input type="text"/> = 3	Significant number	<input type="text"/> D ₁

Registering foreign currency

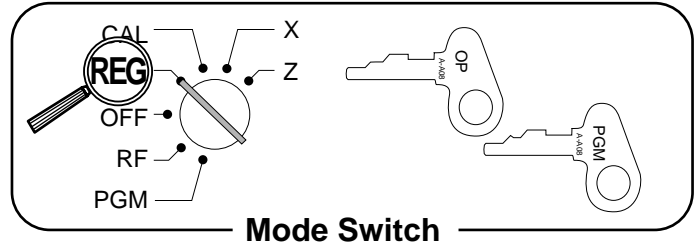

1) Full amount tender in foreign currency

* Pre-programmed exchange rate: ¥ 100 = \$0.9

Important!

Tenders in a foreign currency can be registered using the **CA/AMT =/TEND** and **CHK** keys only. Other finalize keys cannot be used.

OPERATION	DISPLAY	RECEIPT
<p>1 0 00 ← Enter the unit price and press the applicable department key.</p>	<p>01 10.00 (Displays in \$)</p>	<pre> 05-11-2000 13:25 0001 REG C-01 000059 DEPT01 \$10.00 DEPT02 \$20.00 TL \$30.00 CE CA ¥5,000 CA \$45.00 CG \$15.00 </pre>
<p>2 0 00 ← Enter the next unit price and press the applicable department key.</p>	<p>02 20.00 (Displays in \$)</p>	
<p> ← Press the key without entering a numeric value. This operation converts the subtotal (including tax) dollar value into yen by applying a pre-programmed exchange rate. The result is shown on the display but not printed on the receipt or journal.</p>	<p>3333 (Displays in ¥: 3,333)</p>	
<p>5 0 00 (5,000) ← Enter the amount tendered in yen and press the key. This operation converts the entered yen amount into dollars by applying a pre-programmed exchange rate. The result is shown on the display.</p>	<p>45.00 (Displays in \$: 45.00)</p>	
<p> ← Press to finalize the transaction. Note that you do not need to reenter the dollar amount. The register automatically calculates the change amount due in dollars and shows it on the display, receipts and journal.</p>	<p>15.00 (Displays in \$)</p>	















Convenient Operations and Setups

2) Partial tender in a foreign currency

* Pre-programmed exchange rate: ¥ 100 = \$0.9

Important!

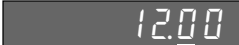
Partial tender in a foreign currency can be registered using the **CA/AMT = /TEND** key and **CHK** keys only. Other finalization keys cannot be used, but the remaining tender can be finalized using any finalize key.

OPERATION	DISPLAY	RECEIPT																											
1 0 00  ← Enter the unit price and press the applicable department key.	 (Displays in \$)	<table border="1"> <tr> <td>05-11-2000</td> <td>13:30</td> <td>0001</td> </tr> <tr> <td>REG</td> <td>C01</td> <td>000060</td> </tr> <tr> <td>DEPT01</td> <td></td> <td>\$10.00</td> </tr> <tr> <td>DEPT02</td> <td></td> <td>\$20.00</td> </tr> <tr> <td>TL</td> <td></td> <td>\$30.00</td> </tr> <tr> <td>CE</td> <td></td> <td></td> </tr> <tr> <td>CA</td> <td></td> <td>¥2,000</td> </tr> <tr> <td>CA</td> <td></td> <td>\$18.00</td> </tr> <tr> <td>CHK</td> <td></td> <td>\$12.00</td> </tr> </table>	05-11-2000	13:30	0001	REG	C01	000060	DEPT01		\$10.00	DEPT02		\$20.00	TL		\$30.00	CE			CA		¥2,000	CA		\$18.00	CHK		\$12.00
05-11-2000	13:30		0001																										
REG	C01		000060																										
DEPT01			\$10.00																										
DEPT02		\$20.00																											
TL		\$30.00																											
CE																													
CA		¥2,000																											
CA		\$18.00																											
CHK		\$12.00																											
2 0 00  ← Enter the next unit price and press the applicable department key.	 (Displays in \$)																												
 ← Press the  key without entering a numeric value. This operation converts the subtotal (including tax) dollar value into yen by applying a pre-programmed exchange rate. The result is shown on the display but not printed on the receipt or journal.	 (Displays in ¥: 3,333)																												
2 0 00  (2,000) ← Enter the partial amount tendered in yen and press the  key. This operation converts the entered yen amount into dollars by applying a pre-programmed exchange rate. The result is shown on the display.	 (Displays in \$: 18.00)																												
 ← Press the  key to specify cash tender for the yen partial tender. Note that you do not need to reenter the dollar amount. The register automatically deducts the dollar equivalent of the yen amount tendered from the total amount due and shows the amount on the display.	 (Displays in \$)																												
 ← Press to finalize the transaction.	 (Displays in \$)																												

Other function key feature programming

You can define a selection of features for the function keys by specifying an 6-digit program code for each key.

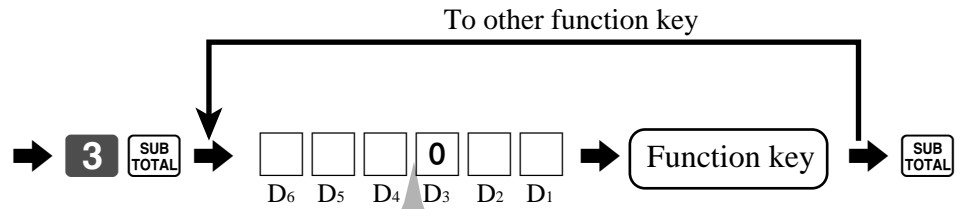
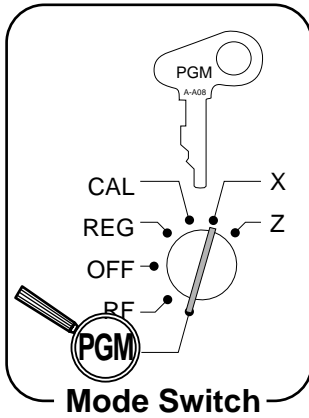

		CA/AMT = /TEND	CH	CHK
High amount limit specification for subtotal and tendering amounts *1	Maximum value (0 ~ 9)	<input type="text"/> <input type="text"/> D ₆ D ₅		
	Number of zeros (0 ~ 9)			
Prohibit entry of a partial payment	a	No = 0 Yes = 1	<input type="text"/> (a+b+c) D ₄	
Prohibit the entry of the amount tendered	b	No = 0 Yes = 2		
Force entry of the amount tendered	c	No = 0 Yes = 4		
Always "0"		<input type="text"/> <input type="text"/> 0 D ₃		
High amount limit specification for change amount due *1	Maximum value (0 ~ 9)	<input type="text"/> <input type="text"/> D ₂ D ₁		
	Number of zeros (0 ~ 9)			

*1 High amounts limits:

High amount limitations are specified as 2-digits. The first digit you specify limits the maximum value of the leftmost digit of the value within the range of 0 through 9. The second digit you specify indicates the number of zeros in the limit value, again within the range of 0 through 9.

Example: \$600.00 maximum ⇨ Enter 64.

Entering "00" clears the limitation.

Convenient Operations and Setups

High amount limit specification for subtotal and tendering amounts *1 (Refer to the previous page.)	Maximum value (0 ~ 9)	<input type="text"/> <input type="text"/>
	Number of zeros (0 ~ 9)	D ₆ D ₅
Always "0000"		<input type="text"/> <input type="text"/> <input type="text"/> <input type="text"/>
		D ₄ D ₃ D ₂ D ₁

Allow a credit balance.	No = 0 Yes = 1	<input type="text"/>
High digit limit specification	Significant number	<input type="text"/>
Taxable status 1	a No = 0 Yes = 1	<input type="text"/>
Taxable status 2	b No = 0 Yes = 2	
Taxable status 3	c No = 0 Yes = 4	
Always "000"		<input type="text"/> <input type="text"/> <input type="text"/>
		D ₃ D ₂ D ₁

Note: If you require tax table 3, please refer to page 39.

Calculator functions

While registering at the REG mode, you can switch to CAL mode and then return to REG mode to resume the registration.

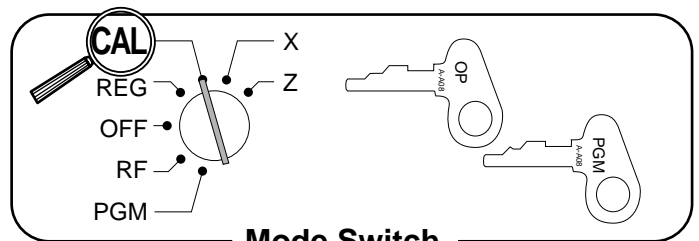

Example 1 (Calculation examples)

	OPERATION	DISPLAY
Clear		
5+3-2=		
(23-56)×78=		
(4×3-6)/3.5+8=		
12 % on 1500		

Example 2 (Memory recall)

Item 1	Unit price	\$10.00
	Quantity	1
	Dept.	1
	Taxable	(1) _{preset}
Item 2	Unit price	\$20.00
	Quantity	1
	Dept.	2
	Taxable	(1) _{preset}
Payment by 3 persons Cash \$10.50 _{each}		

OPERATION

DISPLAY/RECEIPT

Turn to REG

1 0 00 $\frac{4973}{+251}$

2 0 00 $\frac{5074}{-262}$

SUB TOTAL

```
05-11-2000 13:35 0001
REG C01 000061

DEPT01  1  $10.00
DEPT02  1  $20.00
```

Turn to CAL

PLU/S.DEPT

Memory recall:
Recalls subtotal amount

$\frac{5276}{+284}$ 3 $\frac{CA/AMT}{=/TEND}$

Divides the subtotal by 3 persons

315

105

Turn to REG

PLU/S.DEPT

Memory recall:
Recalls the result amount

$\frac{CA/AMT}{=/TEND}$

PLU/S.DEPT $\frac{CA/AMT}{=/TEND}$

PLU/S.DEPT $\frac{CA/AMT}{=/TEND}$

```
TA1 $30.00
TX1 $1.50
TL $31.50
CA $10.50
CA $10.50
CA $10.50
CG $0.00
```

Programming calculator mode control

Open drawer when $\frac{CA/AMT}{=/TEND}$ (equal) is pressed in CAL mode. (Not effective, during registration)	a	No = 0 Yes = 1	
Open drawer when $\frac{\#}{NS}$ is pressed in CAL mode. (Not effective, during registration)	b	No = 0 Yes = 2	
Print $\frac{CA/AMT}{=/TEND}$ (equal) total and count on the daily report.	c	Yes = 0 No = 4	
Always "0000"			

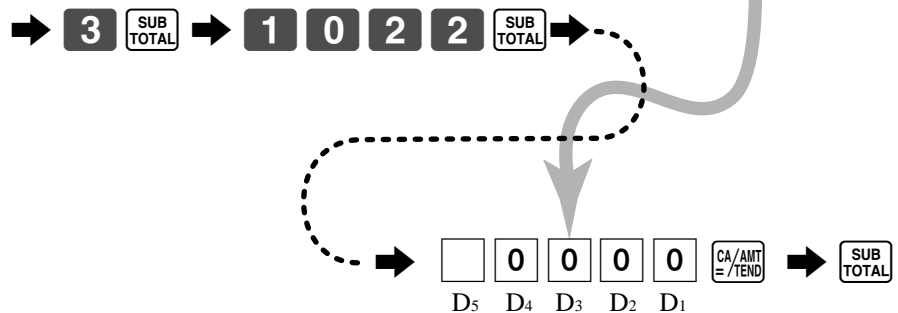
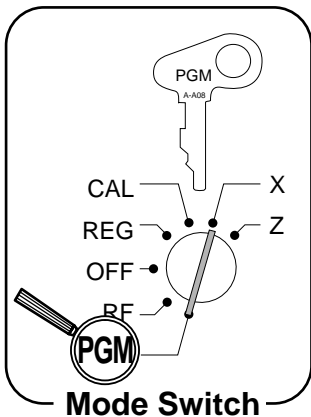

Convenient Operations and Setups

Printing read/reset reports

• Read report

You can print read reports at any time during the business day without affecting the data stored in the cash register's memory.

• Reset report

You should print reset reports at the end of the business day.

Important!

- The reset operation issues a report and also clears all sales data from the cash register's memory.
- Be sure to perform the reset operations at the end of each business day. Otherwise, you will not be able to distinguish between the sales data for different dates.

To print the individual department, PLU/subdepartment read report

This report shows sales for specific departments or PLU/subdepartments.

OPERATION	REPORT																																																								
<p>Mode Switch</p>	<table border="1"> <tr> <td>05-11-2000</td> <td>17:05</td> <td>0001</td> <td>Date/time/machine No.</td> </tr> <tr> <td>X</td> <td>C01</td> <td>000250</td> <td>Read mode/clerk/consecutive No.</td> </tr> <tr> <td></td> <td></td> <td>X</td> <td>Read symbol</td> </tr> <tr> <td>DEPT01</td> <td>QT</td> <td>15</td> <td>Department No./No. of items</td> </tr> <tr> <td>29.6%</td> <td></td> <td>\$339.50</td> <td>Sales ratio/department amount</td> </tr> <tr> <td>DEPT02</td> <td>QT</td> <td>19</td> <td></td> </tr> <tr> <td>5.46%</td> <td></td> <td>\$62.70</td> <td></td> </tr> <tr> <td>PLU001</td> <td>QT</td> <td>31</td> <td>PLU No./No. of items</td> </tr> <tr> <td>12.12%</td> <td></td> <td>\$139.10</td> <td>Sales ratio/PLU amount</td> </tr> <tr> <td>PLU002</td> <td>QT</td> <td>23</td> <td></td> </tr> <tr> <td>29%</td> <td></td> <td>\$332.67</td> <td></td> </tr> <tr> <td colspan="3">-----</td> <td></td> </tr> <tr> <td>TOTAL</td> <td>QT</td> <td>88</td> <td>Total No. of items</td> </tr> <tr> <td>76.19%</td> <td></td> <td>\$873.97</td> <td>Total amount</td> </tr> </table>	05-11-2000	17:05	0001	Date/time/machine No.	X	C01	000250	Read mode/clerk/consecutive No.			X	Read symbol	DEPT01	QT	15	Department No./No. of items	29.6%		\$339.50	Sales ratio/department amount	DEPT02	QT	19		5.46%		\$62.70		PLU001	QT	31	PLU No./No. of items	12.12%		\$139.10	Sales ratio/PLU amount	PLU002	QT	23		29%		\$332.67		-----				TOTAL	QT	88	Total No. of items	76.19%		\$873.97	Total amount
05-11-2000	17:05	0001	Date/time/machine No.																																																						
X	C01	000250	Read mode/clerk/consecutive No.																																																						
		X	Read symbol																																																						
DEPT01	QT	15	Department No./No. of items																																																						
29.6%		\$339.50	Sales ratio/department amount																																																						
DEPT02	QT	19																																																							
5.46%		\$62.70																																																							
PLU001	QT	31	PLU No./No. of items																																																						
12.12%		\$139.10	Sales ratio/PLU amount																																																						
PLU002	QT	23																																																							
29%		\$332.67																																																							

TOTAL	QT	88	Total No. of items																																																						
76.19%		\$873.97	Total amount																																																						
<p>• Specifying a department *</p> <p>* Dept. 01 ~ 24</p> <p>Dept. 25 ~ 48</p> <p>Dept. 49 ~ 72</p> <p>Dept. 73 ~ 96</p>																																																									
<p>• Specifying a PLU **</p> <p>** 1 ~ 6 0 0</p>																																																									
<p>SUB TOTAL</p>																																																									

After you finish to select departments, PLU/subdepartments, press **SUB TOTAL** to terminate.

To print the financial read report

This report shows gross sales, net sales, cash in drawer and check in drawer.

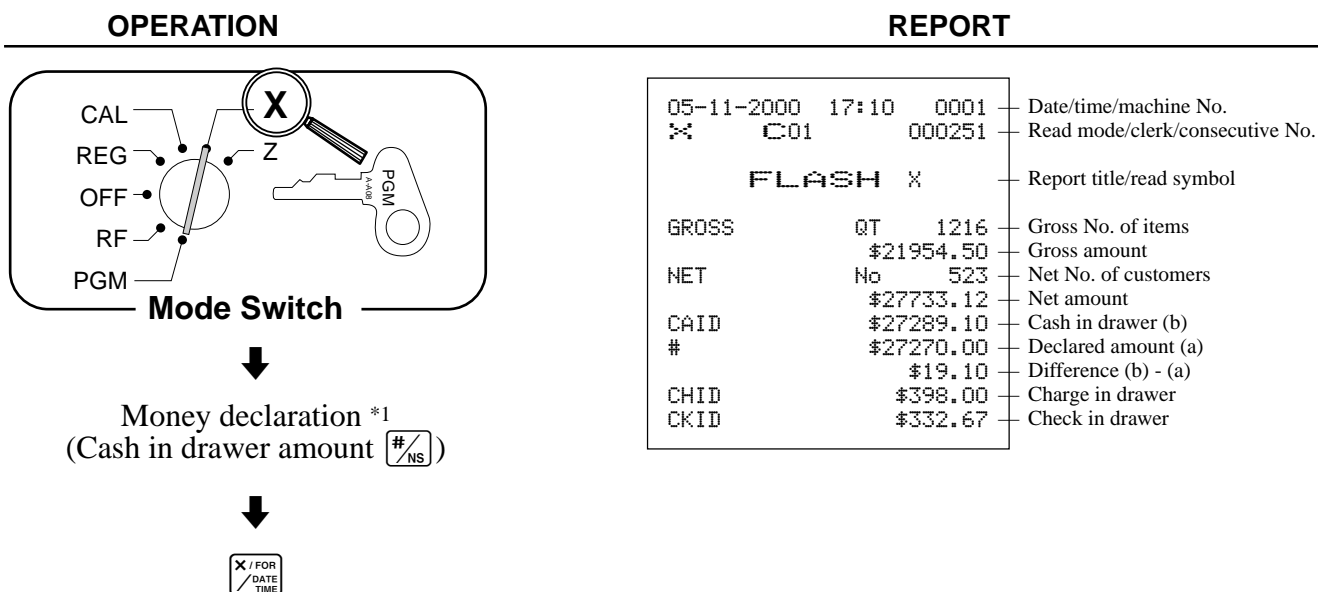

*1 Money declaration:

Count how much cash is in the drawer and input this amount (up to 10-digits).

The cash register will automatically compare the input with the cash in drawer in the memory and print the difference between these two amounts.

Note that if money declaration is required by programming (page 51), you cannot skip this procedure.

To print the group read report

This report shows group totals.

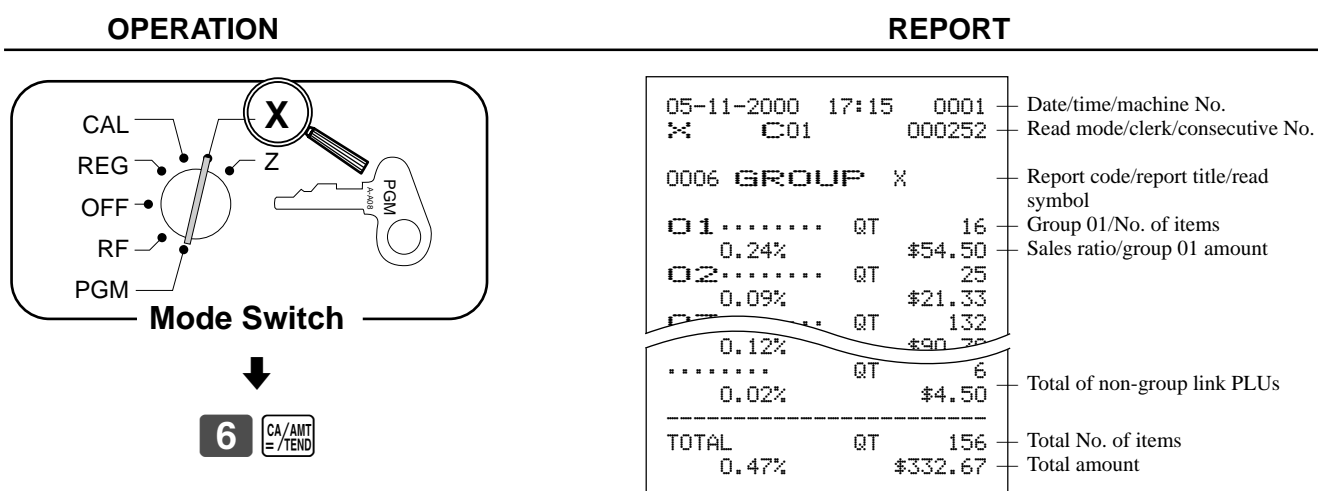

Convenient Operations and Setups

To print the daily sales read/reset report

This report shows sales except for PLUs.

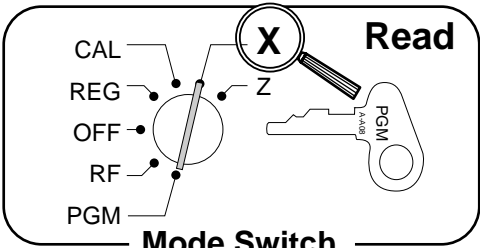
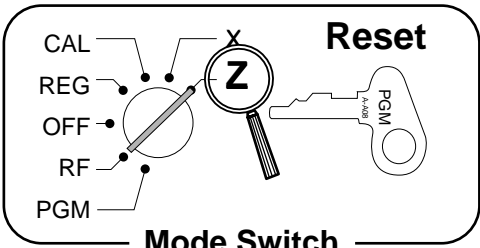
OPERATION	REPORT																																																																																																																																																																																																																														
 <p style="text-align: center;">Mode Switch</p>	 <p style="text-align: center;">Mode Switch</p>																																																																																																																																																																																																																														
<p>Money declaration *1 (Cash in drawer amount $\frac{\#}{NS}$)</p> <p style="text-align: center;">↓</p> <div style="border: 1px solid black; padding: 2px; display: inline-block;">CA/AMT = /TEND</div> <p style="text-align: center;">↓</p>																																																																																																																																																																																																																															
<table border="0" style="width: 100%; border-collapse: collapse;"> <tr> <td style="width: 20%;">05-11-2000</td> <td style="width: 20%;">17:20</td> <td style="width: 20%;">0001</td> <td style="width: 40%;">Date/time/machine No.</td> </tr> <tr> <td>Z</td> <td>C01</td> <td>000253</td> <td>Reset mode/clerk/consecutive No.</td> </tr> <tr> <td colspan="3">0000 DAILY Z 0001</td> <td>Report code/report title/reset symbol/ reset counter *5</td> </tr> <tr> <td>DEPT01</td> <td>QT</td> <td>1015</td> <td>Department No./No. of items *2</td> </tr> <tr> <td>47.07%</td> <td></td> <td>\$10339.50</td> <td>Sales ratio/department amount *2</td> </tr> <tr> <td>DEPT02</td> <td>QT</td> <td>19</td> <td></td> </tr> <tr> <td>31.87%</td> <td></td> <td>\$7000.70</td> <td></td> </tr> <tr> <td>DEPT03</td> <td>QT</td> <td>31</td> <td></td> </tr> <tr> <td>18.84%</td> <td></td> <td>\$4139.10</td> <td></td> </tr> <tr> <td>DEPT04</td> <td>QT</td> <td>23</td> <td></td> </tr> <tr> <td>1.51%</td> <td></td> <td>\$332.67</td> <td></td> </tr> <tr> <td>NON-LINK_DEPT</td> <td>QT</td> <td>10</td> <td>Non-link department No. of items</td> </tr> <tr> <td>0.43%</td> <td></td> <td>\$94.90</td> <td>Non-link department amount</td> </tr> <tr> <td colspan="4">-----</td> </tr> <tr> <td>GRS</td> <td>QT</td> <td>1253</td> <td>Gross No. of items</td> </tr> <tr> <td></td> <td></td> <td>\$21960.90</td> <td>Gross sales amount</td> </tr> <tr> <td>NET</td> <td>No</td> <td>545</td> <td>No. of customers</td> </tr> <tr> <td></td> <td></td> <td>\$30217.63</td> <td>Net sales amount</td> </tr> <tr> <td>CAID</td> <td></td> <td>\$29903.06</td> <td>Cash in drawer amount (b)</td> </tr> <tr> <td>#</td> <td></td> <td>\$29903.06</td> <td>Declared amount (a)</td> </tr> <tr> <td></td> <td></td> <td>\$0.00</td> <td>Difference (b) - (a)</td> </tr> <tr> <td>CHID</td> <td></td> <td>\$197.17</td> <td>Charge in drawer amount</td> </tr> <tr> <td>CKID</td> <td></td> <td>\$183.60</td> <td>Check in drawer amount</td> </tr> <tr> <td>TA1</td> <td></td> <td>\$732.56</td> <td>Taxable amount 1 *3</td> </tr> <tr> <td>TX1</td> <td></td> <td>\$43.96</td> <td>Tax amount 1 *3</td> </tr> <tr> <td>TA2</td> <td></td> <td>\$409.72</td> <td>Taxable amount 2 *3</td> </tr> <tr> <td>TX2</td> <td></td> <td>\$21.55</td> <td>Tax amount 2 *3</td> </tr> </table>	05-11-2000	17:20	0001	Date/time/machine No.	Z	C01	000253	Reset mode/clerk/consecutive No.	0000 DAILY Z 0001			Report code/report title/reset symbol/ reset counter *5	DEPT01	QT	1015	Department No./No. of items *2	47.07%		\$10339.50	Sales ratio/department amount *2	DEPT02	QT	19		31.87%		\$7000.70		DEPT03	QT	31		18.84%		\$4139.10		DEPT04	QT	23		1.51%		\$332.67		NON-LINK_DEPT	QT	10	Non-link department No. of items	0.43%		\$94.90	Non-link department amount	-----				GRS	QT	1253	Gross No. of items			\$21960.90	Gross sales amount	NET	No	545	No. of customers			\$30217.63	Net sales amount	CAID		\$29903.06	Cash in drawer amount (b)	#		\$29903.06	Declared amount (a)			\$0.00	Difference (b) - (a)	CHID		\$197.17	Charge in drawer amount	CKID		\$183.60	Check in drawer amount	TA1		\$732.56	Taxable amount 1 *3	TX1		\$43.96	Tax amount 1 *3	TA2		\$409.72	Taxable amount 2 *3	TX2		\$21.55	Tax amount 2 *3	<table border="0" style="width: 100%; border-collapse: collapse;"> <tr> <td style="width: 20%;">TAX</td> <td style="width: 20%;">\$272.50</td> <td style="width: 60%;">Taxable amount 3 *3</td> </tr> <tr> <td>TX3</td> <td>\$8.18</td> <td>Tax amount 3 *3</td> </tr> <tr> <td>CANCEL</td> <td>No 2</td> <td>Cancellation count</td> </tr> <tr> <td></td> <td>\$108.52</td> <td>Cancellation amount</td> </tr> <tr> <td>RF MODE</td> <td>No 2</td> <td>Refund mode operation count *4</td> </tr> <tr> <td></td> <td>\$3.74</td> <td>Refund mode operation amount *4</td> </tr> <tr> <td>CAL</td> <td>No 10</td> <td>CAL mode operation count *4</td> </tr> <tr> <td colspan="3">-----</td> </tr> <tr> <td>CA</td> <td>No 81</td> <td>Cash sales count *2</td> </tr> <tr> <td></td> <td>\$836.86</td> <td>Cash sales amount *2</td> </tr> <tr> <td>CH</td> <td>No 10</td> <td>Charge sales count *2</td> </tr> <tr> <td></td> <td>\$197.17</td> <td>Charge sales amount *2</td> </tr> <tr> <td>CHK</td> <td>No 9</td> <td>Check sales count *2</td> </tr> <tr> <td></td> <td>\$183.60</td> <td>Check sales amount *2</td> </tr> <tr> <td>-</td> <td>No 8</td> <td>Subtraction count *2</td> </tr> <tr> <td></td> <td>\$3.00</td> <td>Subtraction amount *2</td> </tr> <tr> <td>%</td> <td>No 10</td> <td>Discount count *2</td> </tr> <tr> <td></td> <td>\$4.62</td> <td>Discount amount *2</td> </tr> <tr> <td>RF</td> <td>No 7</td> <td>Refund key count *2 *4</td> </tr> <tr> <td></td> <td>\$27.79</td> <td>Refund key amount *2 *4</td> </tr> <tr> <td>CORR</td> <td>No 10</td> <td>Error correction count *2</td> </tr> <tr> <td></td> <td>\$12.76</td> <td>Error correction amount *2</td> </tr> <tr> <td>#/NS</td> <td>No 5</td> <td>No sale count *2</td> </tr> <tr> <td>RC</td> <td>No 2</td> <td>Received on Account count *2</td> </tr> <tr> <td></td> <td>\$78.00</td> <td>Received on Account amount *2</td> </tr> <tr> <td>PD</td> <td>No 1</td> <td>Paid out count *2</td> </tr> <tr> <td></td> <td>\$6.80</td> <td>Paid out amount *2</td> </tr> <tr> <td colspan="3">-----</td> </tr> <tr> <td>C01</td> <td>No 12</td> <td>Clerk 1/clerk 1 sales count</td> </tr> <tr> <td></td> <td>\$127.63</td> <td>Clerk 1 sales amount</td> </tr> <tr> <td>TRAINING</td> <td></td> <td></td> </tr> <tr> <td>C02</td> <td>No 6</td> <td>Training clerk</td> </tr> <tr> <td></td> <td>\$27.63</td> <td></td> </tr> <tr> <td>TRAINING</td> <td></td> <td></td> </tr> <tr> <td>C03</td> <td>No 24</td> <td></td> </tr> <tr> <td colspan="3">-----</td> </tr> <tr> <td>GT</td> <td>\$0000351217.63</td> <td>Non-resettable grand-sales total</td> </tr> <tr> <td></td> <td>000001---->000253</td> <td>Consecutive No. range of the day *4</td> </tr> </table>	TAX	\$272.50	Taxable amount 3 *3	TX3	\$8.18	Tax amount 3 *3	CANCEL	No 2	Cancellation count		\$108.52	Cancellation amount	RF MODE	No 2	Refund mode operation count *4		\$3.74	Refund mode operation amount *4	CAL	No 10	CAL mode operation count *4	-----			CA	No 81	Cash sales count *2		\$836.86	Cash sales amount *2	CH	No 10	Charge sales count *2		\$197.17	Charge sales amount *2	CHK	No 9	Check sales count *2		\$183.60	Check sales amount *2	-	No 8	Subtraction count *2		\$3.00	Subtraction amount *2	%	No 10	Discount count *2		\$4.62	Discount amount *2	RF	No 7	Refund key count *2 *4		\$27.79	Refund key amount *2 *4	CORR	No 10	Error correction count *2		\$12.76	Error correction amount *2	#/NS	No 5	No sale count *2	RC	No 2	Received on Account count *2		\$78.00	Received on Account amount *2	PD	No 1	Paid out count *2		\$6.80	Paid out amount *2	-----			C01	No 12	Clerk 1/clerk 1 sales count		\$127.63	Clerk 1 sales amount	TRAINING			C02	No 6	Training clerk		\$27.63		TRAINING			C03	No 24		-----			GT	\$0000351217.63	Non-resettable grand-sales total		000001---->000253	Consecutive No. range of the day *4
05-11-2000	17:20	0001	Date/time/machine No.																																																																																																																																																																																																																												
Z	C01	000253	Reset mode/clerk/consecutive No.																																																																																																																																																																																																																												
0000 DAILY Z 0001			Report code/report title/reset symbol/ reset counter *5																																																																																																																																																																																																																												
DEPT01	QT	1015	Department No./No. of items *2																																																																																																																																																																																																																												
47.07%		\$10339.50	Sales ratio/department amount *2																																																																																																																																																																																																																												
DEPT02	QT	19																																																																																																																																																																																																																													
31.87%		\$7000.70																																																																																																																																																																																																																													
DEPT03	QT	31																																																																																																																																																																																																																													
18.84%		\$4139.10																																																																																																																																																																																																																													
DEPT04	QT	23																																																																																																																																																																																																																													
1.51%		\$332.67																																																																																																																																																																																																																													
NON-LINK_DEPT	QT	10	Non-link department No. of items																																																																																																																																																																																																																												
0.43%		\$94.90	Non-link department amount																																																																																																																																																																																																																												

GRS	QT	1253	Gross No. of items																																																																																																																																																																																																																												
		\$21960.90	Gross sales amount																																																																																																																																																																																																																												
NET	No	545	No. of customers																																																																																																																																																																																																																												
		\$30217.63	Net sales amount																																																																																																																																																																																																																												
CAID		\$29903.06	Cash in drawer amount (b)																																																																																																																																																																																																																												
#		\$29903.06	Declared amount (a)																																																																																																																																																																																																																												
		\$0.00	Difference (b) - (a)																																																																																																																																																																																																																												
CHID		\$197.17	Charge in drawer amount																																																																																																																																																																																																																												
CKID		\$183.60	Check in drawer amount																																																																																																																																																																																																																												
TA1		\$732.56	Taxable amount 1 *3																																																																																																																																																																																																																												
TX1		\$43.96	Tax amount 1 *3																																																																																																																																																																																																																												
TA2		\$409.72	Taxable amount 2 *3																																																																																																																																																																																																																												
TX2		\$21.55	Tax amount 2 *3																																																																																																																																																																																																																												
TAX	\$272.50	Taxable amount 3 *3																																																																																																																																																																																																																													
TX3	\$8.18	Tax amount 3 *3																																																																																																																																																																																																																													
CANCEL	No 2	Cancellation count																																																																																																																																																																																																																													
	\$108.52	Cancellation amount																																																																																																																																																																																																																													
RF MODE	No 2	Refund mode operation count *4																																																																																																																																																																																																																													
	\$3.74	Refund mode operation amount *4																																																																																																																																																																																																																													
CAL	No 10	CAL mode operation count *4																																																																																																																																																																																																																													

CA	No 81	Cash sales count *2																																																																																																																																																																																																																													
	\$836.86	Cash sales amount *2																																																																																																																																																																																																																													
CH	No 10	Charge sales count *2																																																																																																																																																																																																																													
	\$197.17	Charge sales amount *2																																																																																																																																																																																																																													
CHK	No 9	Check sales count *2																																																																																																																																																																																																																													
	\$183.60	Check sales amount *2																																																																																																																																																																																																																													
-	No 8	Subtraction count *2																																																																																																																																																																																																																													
	\$3.00	Subtraction amount *2																																																																																																																																																																																																																													
%	No 10	Discount count *2																																																																																																																																																																																																																													
	\$4.62	Discount amount *2																																																																																																																																																																																																																													
RF	No 7	Refund key count *2 *4																																																																																																																																																																																																																													
	\$27.79	Refund key amount *2 *4																																																																																																																																																																																																																													
CORR	No 10	Error correction count *2																																																																																																																																																																																																																													
	\$12.76	Error correction amount *2																																																																																																																																																																																																																													
#/NS	No 5	No sale count *2																																																																																																																																																																																																																													
RC	No 2	Received on Account count *2																																																																																																																																																																																																																													
	\$78.00	Received on Account amount *2																																																																																																																																																																																																																													
PD	No 1	Paid out count *2																																																																																																																																																																																																																													
	\$6.80	Paid out amount *2																																																																																																																																																																																																																													

C01	No 12	Clerk 1/clerk 1 sales count																																																																																																																																																																																																																													
	\$127.63	Clerk 1 sales amount																																																																																																																																																																																																																													
TRAINING																																																																																																																																																																																																																															
C02	No 6	Training clerk																																																																																																																																																																																																																													
	\$27.63																																																																																																																																																																																																																														
TRAINING																																																																																																																																																																																																																															
C03	No 24																																																																																																																																																																																																																														

GT	\$0000351217.63	Non-resettable grand-sales total																																																																																																																																																																																																																													
	000001---->000253	Consecutive No. range of the day *4																																																																																																																																																																																																																													

*1 Money declaration:

Count how much cash is in the drawer and input this amount (up to 10-digits).

The cash register will automatically compare the input with the cash in drawer in the memory and print the difference between these two amounts.

Note that if money declaration is required by programming (page 51), you cannot skip this procedure.

*2 Zero totaled departments/transaction keys (the amount and item numbers are both zero) are not printed.

*3 Taxable amount and tax amount are printed only the corresponding tax table is programmed.

*4 These items can be skipped by programming.

5 The "" symbol is printed on the reset report, memory overflow occurred in the totalizer.

To print the PLU/subdepartment read/reset report

This report shows sales for PLUs/subdepartments.

OPERATION	REPORT																										
<p>Read</p> <p>Mode Switch</p> <p>1 CA/AMT = /TEND</p>	<table border="1"> <tr> <td>05-11-2000 17:25 0001</td> <td>Date/time/machine No.</td> </tr> <tr> <td>Z C01 000254</td> <td>Read mode/clerk/consecutive No.</td> </tr> <tr> <td>0001 PLU Z 0001</td> <td>Report code/report title/reset symbol/reset counter</td> </tr> <tr> <td>PLU001 QT 16</td> <td>PLU001/No. of items</td> </tr> <tr> <td>0.24% \$54.50</td> <td>Sales ratio/PLU001 amount</td> </tr> <tr> <td>PLU002 QT 25</td> <td></td> </tr> <tr> <td>0.09% \$21.33</td> <td></td> </tr> <tr> <td>PLU003 QT 132</td> <td></td> </tr> <tr> <td></td> <td></td> </tr> <tr> <td>PLU200 QT 156</td> <td>Total No. of items</td> </tr> <tr> <td>0.02% \$4.50</td> <td>Total amount</td> </tr> <tr> <td>TOTAL QT 156</td> <td>Total No. of items</td> </tr> <tr> <td>100% \$21960.90</td> <td>Total amount</td> </tr> </table>	05-11-2000 17:25 0001	Date/time/machine No.	Z C01 000254	Read mode/clerk/consecutive No.	0001 PLU Z 0001	Report code/report title/reset symbol/reset counter	PLU001 QT 16	PLU001/No. of items	0.24% \$54.50	Sales ratio/PLU001 amount	PLU002 QT 25		0.09% \$21.33		PLU003 QT 132				PLU200 QT 156	Total No. of items	0.02% \$4.50	Total amount	TOTAL QT 156	Total No. of items	100% \$21960.90	Total amount
05-11-2000 17:25 0001		Date/time/machine No.																									
Z C01 000254	Read mode/clerk/consecutive No.																										
0001 PLU Z 0001	Report code/report title/reset symbol/reset counter																										
PLU001 QT 16	PLU001/No. of items																										
0.24% \$54.50	Sales ratio/PLU001 amount																										
PLU002 QT 25																											
0.09% \$21.33																											
PLU003 QT 132																											
PLU200 QT 156	Total No. of items																										
0.02% \$4.50	Total amount																										
TOTAL QT 156	Total No. of items																										
100% \$21960.90	Total amount																										
<p>Reset</p> <p>Mode Switch</p> <p>1 CA/AMT = /TEND</p>																											

To print the hourly sales read/reset report

This report shows hourly breakdowns of sales.

OPERATION	REPORT																												
<p>Read</p> <p>Mode Switch</p> <p>2 CA/AMT = /TEND</p>	<table border="1"> <tr> <td>05-11-2000 17:30 0001</td> <td>Date/time/machine No.</td> </tr> <tr> <td>Z C01 000255</td> <td>Read mode/clerk/consecutive No.</td> </tr> <tr> <td>0002 HOURLY Z 0001</td> <td>Report code/report title/reset symbol/reset counter</td> </tr> <tr> <td>00:00-01:00 No 6</td> <td>Time range/No. of customers</td> </tr> <tr> <td></td> <td>Sales amount</td> </tr> <tr> <td>01:00-02:00 No 25</td> <td></td> </tr> <tr> <td></td> <td>\$4.50</td> </tr> <tr> <td>02:00-03:00 No 132</td> <td></td> </tr> <tr> <td></td> <td>\$21.33</td> </tr> <tr> <td></td> <td>\$90.78</td> </tr> <tr> <td>23:00-24:00 No 1</td> <td></td> </tr> <tr> <td></td> <td>\$1.50</td> </tr> <tr> <td>TOTAL No 56</td> <td>Total No. of customers</td> </tr> <tr> <td></td> <td>\$1338.40</td> </tr> </table>	05-11-2000 17:30 0001	Date/time/machine No.	Z C01 000255	Read mode/clerk/consecutive No.	0002 HOURLY Z 0001	Report code/report title/reset symbol/reset counter	00:00-01:00 No 6	Time range/No. of customers		Sales amount	01:00-02:00 No 25			\$4.50	02:00-03:00 No 132			\$21.33		\$90.78	23:00-24:00 No 1			\$1.50	TOTAL No 56	Total No. of customers		\$1338.40
05-11-2000 17:30 0001		Date/time/machine No.																											
Z C01 000255	Read mode/clerk/consecutive No.																												
0002 HOURLY Z 0001	Report code/report title/reset symbol/reset counter																												
00:00-01:00 No 6	Time range/No. of customers																												
	Sales amount																												
01:00-02:00 No 25																													
	\$4.50																												
02:00-03:00 No 132																													
	\$21.33																												
	\$90.78																												
23:00-24:00 No 1																													
	\$1.50																												
TOTAL No 56	Total No. of customers																												
	\$1338.40																												
<p>Reset</p> <p>Mode Switch</p> <p>2 CA/AMT = /TEND</p>																													

Convenient Operations and Setups

To print the monthly sales read/reset report

This report shows monthly breakdowns of sales.

OPERATION	REPORT																														
<p>Read</p> <p>Mode Switch</p> <p>3 CA/AMT =/TEND</p>	<table border="1"> <tr> <td>05-11-2000 17:35 0001</td> <td colspan="2">Date/time/machine No.</td> </tr> <tr> <td>Z C01 000256</td> <td colspan="2">Read mode/clerk/consecutive No.</td> </tr> <tr> <td>0003 MONTHLY Z 0001</td> <td colspan="2">Report code/report title/reset symbol/reset counter</td> </tr> <tr> <td>1.... No 6</td> <td colspan="2">Date of a month/No. of customers</td> </tr> <tr> <td>2.... No \$4.50</td> <td colspan="2">Sales amount</td> </tr> <tr> <td>3.... No \$21.33</td> <td colspan="2"></td> </tr> <tr> <td>31.... No \$90.78</td> <td colspan="2"></td> </tr> <tr> <td>31.... No \$1.50</td> <td colspan="2"></td> </tr> <tr> <td>TOTAL No 56</td> <td colspan="2">Total No. of customers</td> </tr> <tr> <td>\$1338.40</td> <td colspan="2">Total amount</td> </tr> </table>	05-11-2000 17:35 0001	Date/time/machine No.		Z C01 000256	Read mode/clerk/consecutive No.		0003 MONTHLY Z 0001	Report code/report title/reset symbol/reset counter		1.... No 6	Date of a month/No. of customers		2.... No \$4.50	Sales amount		3.... No \$21.33			31.... No \$90.78			31.... No \$1.50			TOTAL No 56	Total No. of customers		\$1338.40	Total amount	
05-11-2000 17:35 0001	Date/time/machine No.																														
Z C01 000256	Read mode/clerk/consecutive No.																														
0003 MONTHLY Z 0001	Report code/report title/reset symbol/reset counter																														
1.... No 6	Date of a month/No. of customers																														
2.... No \$4.50	Sales amount																														
3.... No \$21.33																															
31.... No \$90.78																															
31.... No \$1.50																															
TOTAL No 56	Total No. of customers																														
\$1338.40	Total amount																														
<p>Reset</p> <p>Mode Switch</p> <p>3 CA/AMT =/TEND</p>																															

To print the periodic 1/2 sales read/reset reports

These reports show sales breakdowns of sales by any two kinds of period you want.

OPERATION	REPORT																																																																																																																				
<p>Mode Switch</p> <p>↓</p> <p>1 0 0 (Periodic-1) 3 0 0 (Periodic-2)</p> <p>↓</p> <p>CA/AMT = /TEND</p>	<p>Mode Switch</p> <p>↓</p> <p>2 0 0 (Periodic-1) 4 0 0 (Periodic-2)</p> <p>↓</p> <p>CA/AMT = /TEND</p>																																																																																																																				
<table border="1" style="width: 100%; border-collapse: collapse;"> <tr> <td>06-30-2000 17:40 0001</td> <td>Date/time/machine No.</td> </tr> <tr> <td>Z C01 000257</td> <td>Reset mode/clerk/consecutive No.</td> </tr> <tr> <td>0200 PERIODIC-1 ZZ0001</td> <td>Report code/report title/reset symbol/reset counter</td> </tr> <tr> <td>DEPT01 QT 1015</td> <td>Department No./No. of items *1</td> </tr> <tr> <td>47.07% \$10339.50</td> <td>Sales ratio/department amount *1</td> </tr> <tr> <td>DEPT02 QT 19</td> <td></td> </tr> <tr> <td>31.87% \$7000.70</td> <td></td> </tr> <tr> <td>DEPT03 QT 31</td> <td></td> </tr> <tr> <td>18.84% \$4139.10</td> <td></td> </tr> <tr> <td>DEPT04 QT 23</td> <td></td> </tr> <tr> <td>1.51% \$332.67</td> <td></td> </tr> <tr> <td>NON-LINK_DEPT QT 10</td> <td>Non-link department No. of items</td> </tr> <tr> <td>0.43% \$94.90</td> <td>Non-link department amount</td> </tr> <tr> <td colspan="2">-----</td> </tr> <tr> <td>GRS QT 1253</td> <td>Gross No. of items</td> </tr> <tr> <td>\$21960.90</td> <td>Gross sales amount</td> </tr> <tr> <td>NET No 545</td> <td>No. of customers</td> </tr> <tr> <td>\$30217.63</td> <td>Net sales amount</td> </tr> <tr> <td>CAID \$29903.06</td> <td>Cash in drawer amount</td> </tr> <tr> <td>CHID \$197.17</td> <td>Charge in drawer amount</td> </tr> <tr> <td>CKID \$183.60</td> <td>Check in drawer amount</td> </tr> <tr> <td>TA1 \$732.56</td> <td>Taxable amount 1 *2</td> </tr> <tr> <td>TX1 \$43.96</td> <td>Tax amount 1 *2</td> </tr> <tr> <td>TA2 \$409.72</td> <td>Taxable amount 2 *2</td> </tr> <tr> <td>TX2 \$21.55</td> <td>Tax amount 2 *2</td> </tr> <tr> <td>TA3 \$272.50</td> <td>Taxable amount 3 *2</td> </tr> <tr> <td>TX3 \$8.18</td> <td>Tax amount 3 *2</td> </tr> <tr> <td>CANCEL No 2</td> <td>Cancellation count</td> </tr> <tr> <td>\$108.52</td> <td>Cancellation amount</td> </tr> <tr> <td>RF MODE No 2</td> <td>Refund mode operation count *3</td> </tr> <tr> <td>\$3.74</td> <td>Refund mode operation amount *3</td> </tr> <tr> <td>CAL No 10</td> <td>CAL mode operation count *3</td> </tr> </table>	06-30-2000 17:40 0001	Date/time/machine No.	Z C01 000257	Reset mode/clerk/consecutive No.	0200 PERIODIC-1 ZZ0001	Report code/report title/reset symbol/reset counter	DEPT01 QT 1015	Department No./No. of items *1	47.07% \$10339.50	Sales ratio/department amount *1	DEPT02 QT 19		31.87% \$7000.70		DEPT03 QT 31		18.84% \$4139.10		DEPT04 QT 23		1.51% \$332.67		NON-LINK_DEPT QT 10	Non-link department No. of items	0.43% \$94.90	Non-link department amount	-----		GRS QT 1253	Gross No. of items	\$21960.90	Gross sales amount	NET No 545	No. of customers	\$30217.63	Net sales amount	CAID \$29903.06	Cash in drawer amount	CHID \$197.17	Charge in drawer amount	CKID \$183.60	Check in drawer amount	TA1 \$732.56	Taxable amount 1 *2	TX1 \$43.96	Tax amount 1 *2	TA2 \$409.72	Taxable amount 2 *2	TX2 \$21.55	Tax amount 2 *2	TA3 \$272.50	Taxable amount 3 *2	TX3 \$8.18	Tax amount 3 *2	CANCEL No 2	Cancellation count	\$108.52	Cancellation amount	RF MODE No 2	Refund mode operation count *3	\$3.74	Refund mode operation amount *3	CAL No 10	CAL mode operation count *3	<table border="1" style="width: 100%; border-collapse: collapse;"> <tr> <td>CA No 81</td> <td>Cash sales count *1</td> </tr> <tr> <td>\$836.86</td> <td>Cash sales amount *1</td> </tr> <tr> <td>CH No 10</td> <td>Charge sales count *1</td> </tr> <tr> <td>\$197.17</td> <td>Charge sales amount *1</td> </tr> <tr> <td>CHK No 9</td> <td>Check sales count *1</td> </tr> <tr> <td>\$183.60</td> <td>Check sales amount *1</td> </tr> <tr> <td>- No 8</td> <td>Subtraction count *1</td> </tr> <tr> <td>\$3.00</td> <td>Subtraction amount *1</td> </tr> <tr> <td>% No 10</td> <td>Discount count *1</td> </tr> <tr> <td>\$4.62</td> <td>Discount amount *1</td> </tr> <tr> <td>RF No 7</td> <td>Refund key count *1 *3</td> </tr> <tr> <td>\$27.79</td> <td>Refund key amount *1 *3</td> </tr> <tr> <td>CORR No 10</td> <td>Error correction count *1</td> </tr> <tr> <td>\$12.76</td> <td>Error correction amount *1</td> </tr> <tr> <td>#/NS No 5</td> <td>No sale count *1</td> </tr> <tr> <td>RC No 2</td> <td>Received on Account count *1</td> </tr> <tr> <td>\$78.00</td> <td>Received on Account amount *1</td> </tr> <tr> <td>PD No 1</td> <td>Paid out count *1</td> </tr> <tr> <td>\$6.80</td> <td>Paid out amount *1</td> </tr> <tr> <td colspan="2">-----</td> </tr> <tr> <td>C01 No 12</td> <td>Clerk 1/clerk 1 sales count</td> </tr> <tr> <td>\$127.63</td> <td>Clerk 1 sales amount</td> </tr> <tr> <td>TRAINING C02 No 6</td> <td>Training clerk</td> </tr> <tr> <td>\$27.63</td> <td></td> </tr> <tr> <td>TRAINING C07 No 24</td> <td></td> </tr> <tr> <td>\$217.63</td> <td></td> </tr> </table>	CA No 81	Cash sales count *1	\$836.86	Cash sales amount *1	CH No 10	Charge sales count *1	\$197.17	Charge sales amount *1	CHK No 9	Check sales count *1	\$183.60	Check sales amount *1	- No 8	Subtraction count *1	\$3.00	Subtraction amount *1	% No 10	Discount count *1	\$4.62	Discount amount *1	RF No 7	Refund key count *1 *3	\$27.79	Refund key amount *1 *3	CORR No 10	Error correction count *1	\$12.76	Error correction amount *1	#/NS No 5	No sale count *1	RC No 2	Received on Account count *1	\$78.00	Received on Account amount *1	PD No 1	Paid out count *1	\$6.80	Paid out amount *1	-----		C01 No 12	Clerk 1/clerk 1 sales count	\$127.63	Clerk 1 sales amount	TRAINING C02 No 6	Training clerk	\$27.63		TRAINING C07 No 24		\$217.63	
06-30-2000 17:40 0001	Date/time/machine No.																																																																																																																				
Z C01 000257	Reset mode/clerk/consecutive No.																																																																																																																				
0200 PERIODIC-1 ZZ0001	Report code/report title/reset symbol/reset counter																																																																																																																				
DEPT01 QT 1015	Department No./No. of items *1																																																																																																																				
47.07% \$10339.50	Sales ratio/department amount *1																																																																																																																				
DEPT02 QT 19																																																																																																																					
31.87% \$7000.70																																																																																																																					
DEPT03 QT 31																																																																																																																					
18.84% \$4139.10																																																																																																																					
DEPT04 QT 23																																																																																																																					
1.51% \$332.67																																																																																																																					
NON-LINK_DEPT QT 10	Non-link department No. of items																																																																																																																				
0.43% \$94.90	Non-link department amount																																																																																																																				

GRS QT 1253	Gross No. of items																																																																																																																				
\$21960.90	Gross sales amount																																																																																																																				
NET No 545	No. of customers																																																																																																																				
\$30217.63	Net sales amount																																																																																																																				
CAID \$29903.06	Cash in drawer amount																																																																																																																				
CHID \$197.17	Charge in drawer amount																																																																																																																				
CKID \$183.60	Check in drawer amount																																																																																																																				
TA1 \$732.56	Taxable amount 1 *2																																																																																																																				
TX1 \$43.96	Tax amount 1 *2																																																																																																																				
TA2 \$409.72	Taxable amount 2 *2																																																																																																																				
TX2 \$21.55	Tax amount 2 *2																																																																																																																				
TA3 \$272.50	Taxable amount 3 *2																																																																																																																				
TX3 \$8.18	Tax amount 3 *2																																																																																																																				
CANCEL No 2	Cancellation count																																																																																																																				
\$108.52	Cancellation amount																																																																																																																				
RF MODE No 2	Refund mode operation count *3																																																																																																																				
\$3.74	Refund mode operation amount *3																																																																																																																				
CAL No 10	CAL mode operation count *3																																																																																																																				
CA No 81	Cash sales count *1																																																																																																																				
\$836.86	Cash sales amount *1																																																																																																																				
CH No 10	Charge sales count *1																																																																																																																				
\$197.17	Charge sales amount *1																																																																																																																				
CHK No 9	Check sales count *1																																																																																																																				
\$183.60	Check sales amount *1																																																																																																																				
- No 8	Subtraction count *1																																																																																																																				
\$3.00	Subtraction amount *1																																																																																																																				
% No 10	Discount count *1																																																																																																																				
\$4.62	Discount amount *1																																																																																																																				
RF No 7	Refund key count *1 *3																																																																																																																				
\$27.79	Refund key amount *1 *3																																																																																																																				
CORR No 10	Error correction count *1																																																																																																																				
\$12.76	Error correction amount *1																																																																																																																				
#/NS No 5	No sale count *1																																																																																																																				
RC No 2	Received on Account count *1																																																																																																																				
\$78.00	Received on Account amount *1																																																																																																																				
PD No 1	Paid out count *1																																																																																																																				
\$6.80	Paid out amount *1																																																																																																																				

C01 No 12	Clerk 1/clerk 1 sales count																																																																																																																				
\$127.63	Clerk 1 sales amount																																																																																																																				
TRAINING C02 No 6	Training clerk																																																																																																																				
\$27.63																																																																																																																					
TRAINING C07 No 24																																																																																																																					
\$217.63																																																																																																																					

*1 Zero totalled departments/transaction keys (the amount and item numbers are both zero) are not printed.

*2 Taxable amount and tax amount are printed only the corresponding tax table is programmed.

*3 These items can be skipped by programming.

Convenient Operations and Setups

Reading the cash register's program

To print unit price/rate program (except PLU)

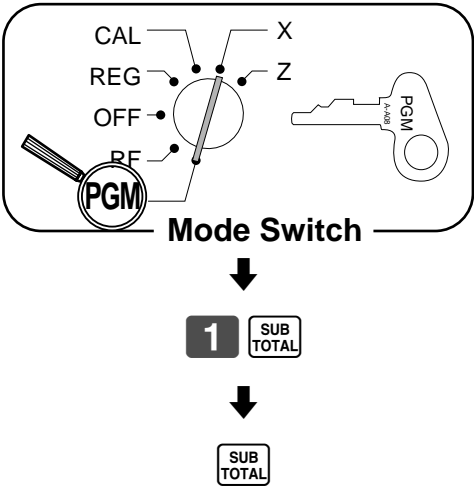
OPERATION	REPORT																																																
 <p>Mode Switch</p> <p>1 SUB TOTAL</p> <p>SUB TOTAL</p>	<table border="1"> <tr> <td>05-11-2000</td> <td>09:30</td> <td>0001</td> <td>Date/time/machine No.</td> </tr> <tr> <td>P 1</td> <td></td> <td>000010</td> <td>Mode/consecutive No.</td> </tr> <tr> <td>P 1.....</td> <td></td> <td></td> <td>Program read symbol</td> </tr> <tr> <td>DEPT01</td> <td>T</td> <td>01.00</td> <td>Dept. No./tax status/unit price *1</td> </tr> <tr> <td>DEPT02</td> <td>T</td> <td>02.00</td> <td></td> </tr> <tr> <td>DEPT03</td> <td>T</td> <td>03.00</td> <td></td> </tr> <tr> <td>DEPT94</td> <td></td> <td>05.00</td> <td></td> </tr> <tr> <td>DEPT95</td> <td></td> <td>05.00</td> <td></td> </tr> <tr> <td>DEPT96</td> <td></td> <td>06.00</td> <td></td> </tr> <tr> <td>-</td> <td>T</td> <td>00.00</td> <td>Reduction preset amount</td> </tr> <tr> <td>%</td> <td>T</td> <td>12.34%</td> <td>Percent rate</td> </tr> <tr> <td>CE</td> <td></td> <td>0.09</td> <td>Currency exchange rate</td> </tr> </table>	05-11-2000	09:30	0001	Date/time/machine No.	P 1		000010	Mode/consecutive No.	P 1.....			Program read symbol	DEPT01	T	01.00	Dept. No./tax status/unit price *1	DEPT02	T	02.00		DEPT03	T	03.00		DEPT94		05.00		DEPT95		05.00		DEPT96		06.00		-	T	00.00	Reduction preset amount	%	T	12.34%	Percent rate	CE		0.09	Currency exchange rate
05-11-2000	09:30	0001	Date/time/machine No.																																														
P 1		000010	Mode/consecutive No.																																														
P 1.....			Program read symbol																																														
DEPT01	T	01.00	Dept. No./tax status/unit price *1																																														
DEPT02	T	02.00																																															
DEPT03	T	03.00																																															
DEPT94		05.00																																															
DEPT95		05.00																																															
DEPT96		06.00																																															
-	T	00.00	Reduction preset amount																																														
%	T	12.34%	Percent rate																																														
CE		0.09	Currency exchange rate																																														

*1 Department without being programmed are not printed on this report.

To print key descriptor, name, message program (except PLU)

OPERATION

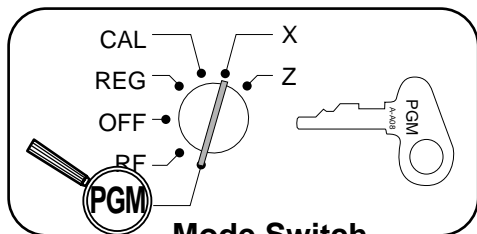

Mode Switch



REPORT

05-11-2000 09:35 0001	Date/time/machine No.
P2 000011	Mode/consecutive No.
P2.....	Program read symbol
GROSS 01	Gross character
NET 02	Net character
CAID 03	Cash in drawer character
CHID 04	Charge in drawer character
CKID 05	Check in drawer character
CECA 06	Foreign currency cash character
CECK 07	Foreign currency check character
TA1 08	Taxable amount 1 character
TX1 09	Tax 1 character
TA2 10	Taxable amount 2 character
TX2 11	Tax 2 character
TA3 12	Taxable amount 3 character
TX3 13	Tax 3 character
CANCEL 14	Cancellation total character
RF MODE 15	Refund mode total character
CAL 16	CAL mode count character
NON-LINK DEPT 17	Non link department character
CHK 04	Check key descriptor
PD 05	Paid out key descriptor
DN OFF 06	
PRC 07	
#/NS 43	#/NS key descriptor
CE 44	Currency exchange key descriptor
- 45	Minus key descriptor
% 46	Percent key descriptor
DEPT01 01	Department 1 key character
DEPT02 02	Department 2 key character
DEPT03 03	Department 3 key character
DEPT95 04	
DEPT96 96	Department 96 key character
C01 01	Clerk 01 character
C02 02	Clerk 02 character
C24 07	
C25 25	Clerk 25 character
GT 01	Grand total character
\$ @NoQT 01	
NoCT 02	
X / 03	
1 1/2 % 04	
* 05	
*** 06	Special character
REG RF 07	
P 08	
SRVC TL 09	
CHECK-# 27	
DAILY 01	
PLU 02	
HOURLY 03	
PERIODIC-1 04	Report header
PERIODIC-2 09	
OPEN CHECK 10	
11 01	
YOUR RECEIPT 02	Receipt message
AGAIN 03	
10	

Convenient Operations and Setups

To print the print control, compulsory clerk program (except PLU)

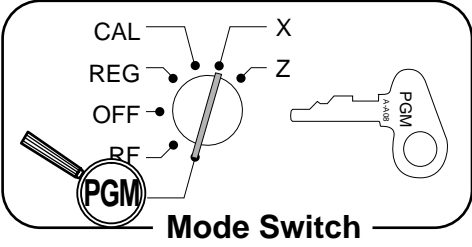
OPERATION	REPORT																																																																																																		
 <p>Mode Switch</p> <p>↓</p> <p>3 SUB TOTAL</p> <p>↓</p> <p>SUB TOTAL</p>	<table border="0"> <tr> <td>05-11-2000 09:40 0001</td> <td>Date/time/machine No.</td> </tr> <tr> <td>P3 000012</td> <td>Mode/consecutive No.</td> </tr> <tr> <td>P3.....</td> <td>Program read symbol</td> </tr> <tr> <td>0122 00000012</td> <td>Print control</td> </tr> <tr> <td>0222 00000000</td> <td></td> </tr> <tr> <td>0522 00000100</td> <td></td> </tr> <tr> <td>0622 00000004</td> <td></td> </tr> <tr> <td>0822 00401000</td> <td></td> </tr> <tr> <td>1022 00000000</td> <td></td> </tr> <tr> <td>0125</td> <td></td> </tr> <tr> <td></td> <td>5%</td> </tr> <tr> <td></td> <td>5002 Tax table 1</td> </tr> <tr> <td></td> <td>0000</td> </tr> <tr> <td>0225</td> <td></td> </tr> <tr> <td></td> <td>10%</td> </tr> <tr> <td></td> <td>5002 Tax table 2</td> </tr> <tr> <td></td> <td>0000</td> </tr> <tr> <td>0325</td> <td></td> </tr> <tr> <td></td> <td>15%</td> </tr> <tr> <td></td> <td>5002 Tax table 3</td> </tr> <tr> <td></td> <td>0000</td> </tr> <tr> <td>C01 01</td> <td>Clerk name</td> </tr> <tr> <td>C02 00 0000 02</td> <td>Training flag/secret No.</td> </tr> <tr> <td>00 0000 06</td> <td></td> </tr> <tr> <td>00 0000</td> <td></td> </tr> <tr> <td>DEPT01 01</td> <td>Dept. No.</td> </tr> <tr> <td>0000000000 01.00</td> <td>Sales status/unit price *1</td> </tr> <tr> <td>DEPT02 02</td> <td></td> </tr> <tr> <td>0000000000 02.00</td> <td></td> </tr> <tr> <td>DEPT96 07</td> <td></td> </tr> <tr> <td>0000000000 00.00</td> <td></td> </tr> <tr> <td>CHK 00002100</td> <td>Check key program</td> </tr> <tr> <td>PD 00000000</td> <td>Paid out key program</td> </tr> <tr> <td>ON/OFF 00000000</td> <td></td> </tr> <tr> <td>CA 00000100</td> <td>Cash key program</td> </tr> <tr> <td>TL 00000000</td> <td></td> </tr> <tr> <td>MDST 00000000</td> <td></td> </tr> <tr> <td>CH 00002100</td> <td>Charge key program</td> </tr> <tr> <td>RC 00000000</td> <td>Received on account key program</td> </tr> <tr> <td>00000000</td> <td></td> </tr> <tr> <td>QT 00000000</td> <td></td> </tr> <tr> <td>OPEN 00000000</td> <td></td> </tr> <tr> <td>CORR 00000000</td> <td></td> </tr> <tr> <td>RF 00000000</td> <td></td> </tr> <tr> <td>PRC 00000000</td> <td></td> </tr> <tr> <td>#/NS 00000000</td> <td></td> </tr> <tr> <td>CE 00000000</td> <td>Currency exchange key program</td> </tr> <tr> <td>- 00000000</td> <td>Minus key program</td> </tr> <tr> <td>% 00000000</td> <td>Percent key program</td> </tr> </table>	05-11-2000 09:40 0001	Date/time/machine No.	P3 000012	Mode/consecutive No.	P3.....	Program read symbol	0122 00000012	Print control	0222 00000000		0522 00000100		0622 00000004		0822 00401000		1022 00000000		0125			5%		5002 Tax table 1		0000	0225			10%		5002 Tax table 2		0000	0325			15%		5002 Tax table 3		0000	C01 01	Clerk name	C02 00 0000 02	Training flag/secret No.	00 0000 06		00 0000		DEPT01 01	Dept. No.	0000000000 01.00	Sales status/unit price *1	DEPT02 02		0000000000 02.00		DEPT96 07		0000000000 00.00		CHK 00002100	Check key program	PD 00000000	Paid out key program	ON/OFF 00000000		CA 00000100	Cash key program	TL 00000000		MDST 00000000		CH 00002100	Charge key program	RC 00000000	Received on account key program	00000000		QT 00000000		OPEN 00000000		CORR 00000000		RF 00000000		PRC 00000000		#/NS 00000000		CE 00000000	Currency exchange key program	- 00000000	Minus key program	% 00000000	Percent key program
05-11-2000 09:40 0001	Date/time/machine No.																																																																																																		
P3 000012	Mode/consecutive No.																																																																																																		
P3.....	Program read symbol																																																																																																		
0122 00000012	Print control																																																																																																		
0222 00000000																																																																																																			
0522 00000100																																																																																																			
0622 00000004																																																																																																			
0822 00401000																																																																																																			
1022 00000000																																																																																																			
0125																																																																																																			
	5%																																																																																																		
	5002 Tax table 1																																																																																																		
	0000																																																																																																		
0225																																																																																																			
	10%																																																																																																		
	5002 Tax table 2																																																																																																		
	0000																																																																																																		
0325																																																																																																			
	15%																																																																																																		
	5002 Tax table 3																																																																																																		
	0000																																																																																																		
C01 01	Clerk name																																																																																																		
C02 00 0000 02	Training flag/secret No.																																																																																																		
00 0000 06																																																																																																			
00 0000																																																																																																			
DEPT01 01	Dept. No.																																																																																																		
0000000000 01.00	Sales status/unit price *1																																																																																																		
DEPT02 02																																																																																																			
0000000000 02.00																																																																																																			
DEPT96 07																																																																																																			
0000000000 00.00																																																																																																			
CHK 00002100	Check key program																																																																																																		
PD 00000000	Paid out key program																																																																																																		
ON/OFF 00000000																																																																																																			
CA 00000100	Cash key program																																																																																																		
TL 00000000																																																																																																			
MDST 00000000																																																																																																			
CH 00002100	Charge key program																																																																																																		
RC 00000000	Received on account key program																																																																																																		
00000000																																																																																																			
QT 00000000																																																																																																			
OPEN 00000000																																																																																																			
CORR 00000000																																																																																																			
RF 00000000																																																																																																			
PRC 00000000																																																																																																			
#/NS 00000000																																																																																																			
CE 00000000	Currency exchange key program																																																																																																		
- 00000000	Minus key program																																																																																																		
% 00000000	Percent key program																																																																																																		

*1 Department without being programmed are not printed on this report.

To print the PLU program

OPERATION

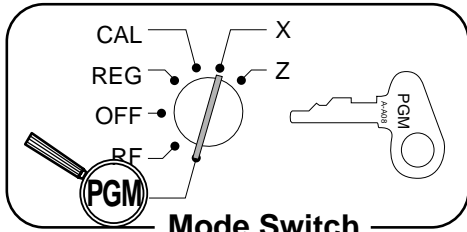

Mode Switch



REPORT

05-11-2000	09:45	0001	Date/time/machine No.
P6		000013	Mode/consecutive No.
P6			Program read symbol
PLU001	T	001	Item character/tax symbol
0000100000		@1.00	Status program/unit price
PLU002		002	
0000000000		@2.00	
PLU003		003	
0000000000		@3.00	
PLU004		004	
0000000000		@4.00	
PLU005		005	
0000000000		@5.00	
PLU006		006	
0000200000		@6.00	
PLU007	T	007	
0000000000		@7.00	
PLU008		008	
0000000000		@8.00	
PLU009		009	
0000000000		@9.00	
PLU010		010	
		@10.00	
PLU599			
0000200000		@599.00	
PLU600		600	
0000000000		@600.00	

Troubleshooting

This section describes what to do when you have problems with operation.

When an error occurs

Errors are indicated by an error tone. When this happens, you can usually find out what the problem is as illustrated below.

ERROR TONE

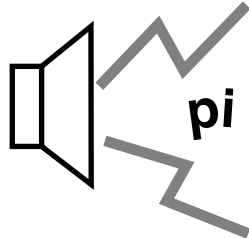

Does the display show an error code?

No

Yes



Error code	Meaning	Action
E01	Mode switch position changed before finalization.	Return the mode switch to its original setting and finalize the operation.
E08	Registration without entering a clerk number. This error appears only when the clerk control function is activated.	Enter a clerk number.
E27	Transaction cancel buffer full.	Finalize the transaction.
E31	Finalization of a transaction attempted without confirming the subtotal.	Press the key.
E33	Finalize operation attempted without entering amount tendered.	Enter the amount tendered.
E35	Change amount exceeds preset limit.	Re-input amount tendered.
E38	Read/reset operation without declaring cash in drawer. This error appears only when this function is activated.	Perform money declaration.
E94	Printer error.	Turn the power off, and remove jammed paper from the printer.

Press key and check the appropriate section of this manual for the operation you want to perform.

When the register does not operate at all

Perform the following check whenever the cash register enter an error condition as soon as you switch it on. The results of this check are required by service personnel, so be sure to perform this check before you contact a CASIO representative for servicing.

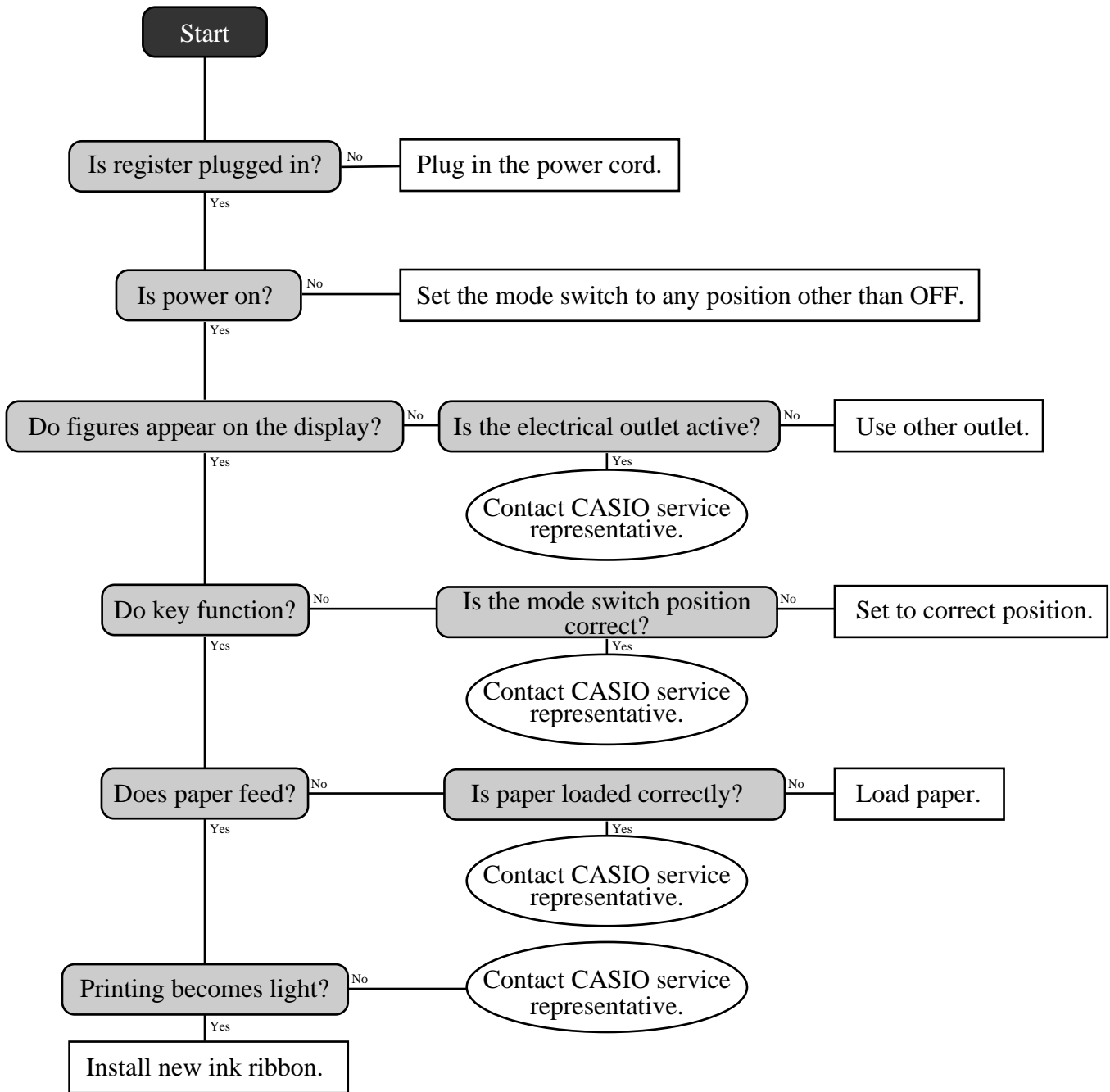

Troubleshooting

In case of power failure

If the power supply to the cash register is cut by a power failure or any other reason, simply wait for power to be restored. The details of any on-going transaction as well as all sales data in memory are protected by the memory backup batteries.

- Power failure during a registration
The subtotal for items registered up to the power failure is retained in memory. You will be able to continue with the registration when power is restored.
- Power failure during printing a read/reset report
The data already printed before the power failure is retained in memory. You will be able to issue a report when power is restored.
- Power failure during printing of a receipt and the journal
Printing will resume after power is restored. A line that was being printed when the power failure occurred is printed in full.
- Other
The power failure symbol is printed and any item that was being printed when the power failure occurred is reprinted in full.

Important!

Once receipt/journal printing or printing of a report starts, it can be stopped only by interruption of power to the cash register.

When the L sign appears on the display

About the low battery indicator...

The following shows the low battery indicator.



If this indicator appears when you switch the cash register on, it can mean one of three things:

- No memory backup batteries are loaded in the cash register.
- The power of the batteries loaded in the unit is below a certain level.
- The batteries loaded in the unit are dead.

To clear this sign, press  key.

Important!

Whenever the low battery indicator appears on the display, load a set of three new batteries as soon as possible. If there is a power failure or you unplug the cash register when this indicator appears, you will lose all of your sales data and settings.

**BE SURE TO KEEP THE POWER CORD OF THE CASH REGISTER
PLUGGED IN WHENEVER YOU REPLACE THE BATTERIES.**

To replace the ink ribbon



①

Remove the printer cover.

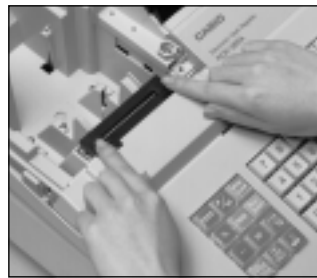

⑤

Load a new ink ribbon cassette into the unit.



②

Cut the journal paper and feed the remaining paper from the printer.

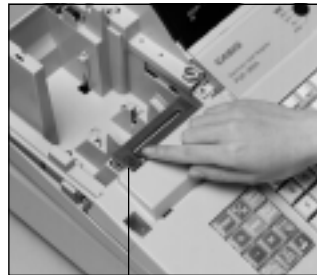

⑥

Turn the knob on the left side of the cassette to take up any slack in the ribbon.

Knob

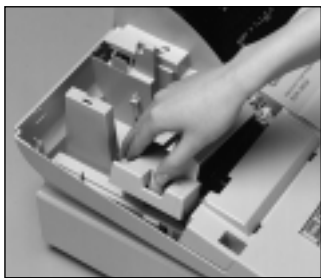

③

Remove the inner cover.

⑦

Reload the roll paper and replace the printer cover .

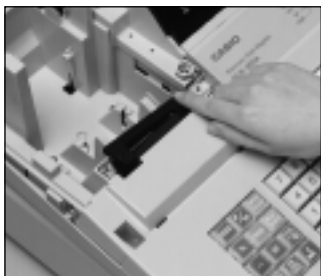

④

Push on the right side of the ribbon cassette where marked with the word "PUSH", to release it.

Important!

Use only the ERC-40P ribbon (purple). Other types of ink ribbons can damage the printer.

Never try to extend the life of an ink ribbon by replenishing the ink.

Once an ink ribbon is in place, press the  key to test for correct operation.

To replace journal paper

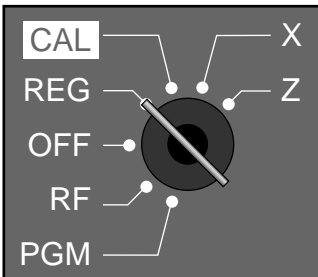

1

Set the mode switch to the REG position and remove the printer cover.



2

Press **FEED** to feed about 20 cm of paper.

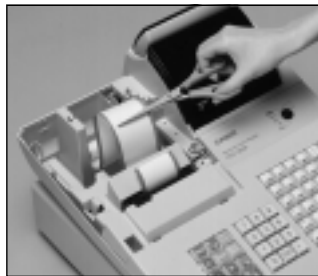

7

Cut the journal paper as shown in the photograph.



3

Cut the journal paper at the point where nothing is printed.

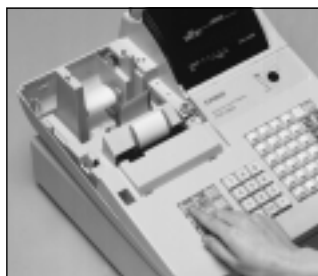

8

Press **FEED** to feed the remaining paper from the printer.



4

Remove the journal take-up reel from its holder.



9

Do not pull the paper out of the printer by hand. It can damage the printer.

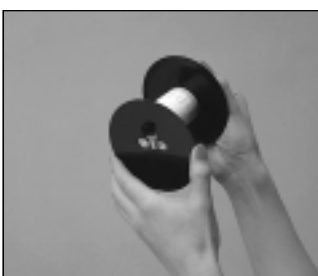

5

Remove the flat plate from the side of the take-up reel.



10

Remove the old paper roll from the cash register.



6

Slide the printed journal from the take-up reel.

11

Load new paper as described on page 10 of this manual.

To replace receipt paper

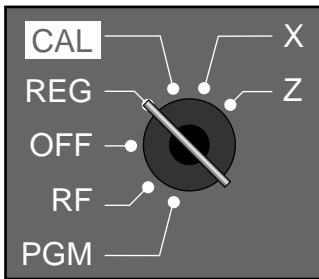

1

Set the mode switch to the REG position and remove the printer cover.



2

Cut the receipt paper as shown in the photograph.



4

Do not pull the paper out of the printer by hand. It can damage the printer.

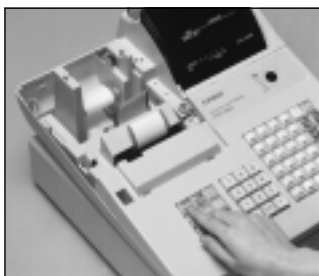

3

Press **FEED** to feed the remaining paper from the printer.



5

Remove the old paper roll from the cash register.

6

Load new paper as described on page 9 of this manual.

Options

WT-73 wetproof cover

The optional wetproof cover protects the keyboard from moisture damage.

Specifications

Input method

Entry: 10-key system; Buffer memory 8 keys (2-key roll over)
 Department: Full key system

Display

Amount 8 digits (Zero suppression); Department No.; PLU No.;
 No. of repeats; TOTAL; CHANGE; X mode; Z mode; Receipt On/Off

Printer

Printer: Single sheet impact dot matrix printer (Receipt or journal printing)
 24 digits (Amount 10 digits/descriptor 8, 12 or 24 digits)
 Journal: Automatic take up roll winding
 Print speed: 2.7 lines/sec.
 Feed speed: 6.5 lines/sec.
 Paper roll: 58 mm × 80 mm Ø (Max.)
 2-ply paper roll 58 mm × 80 mm Ø (Max.)
 CASIO CP-5880

Calculations

Entry 10 digits; Registration 7 digits; Total 10 digits

Chronological data

Date print: Automatic date printout on receipt or journal
 Automatic calendar
 Time print: Automatic time printout on receipt or journal
 Time display: 24-hour system

Alarm

Entry confirmation signal; Error alarm

Totalizers

Category	No. of Totalizers	Contents				Periodic Totalizers
		Amount (10 digits)	No. of items (4 digits)	Count (4 digits)	No. of customers (4 digits)	
Department	96	<input type="radio"/>	<input type="radio"/> (4 digits integer/ 2 digits decimal)			<input type="radio"/>
PLU	600	<input type="radio"/>	<input type="radio"/> (4 digits integer/ 2 digits decimal)			
Hourly sales	24	<input type="radio"/>			<input type="radio"/>	
Clerk*	25	<input type="radio"/>			<input type="radio"/>	<input type="radio"/>
Transaction	27	<input type="radio"/> or <input type="radio"/>	<input type="radio"/> or <input type="radio"/>	<input type="radio"/>	<input type="radio"/>	<input type="radio"/>
Non resettable grand sales total	1	<input type="radio"/> 12 digits				
Reset counter	6			<input type="radio"/>		<input type="radio"/>
Consecutive No.	1			<input type="radio"/> 4 digits		

* Available only when the clerk control function is active on the cash register.

Memory protection batteries

The effective service life of the memory protection batteries (three new SUM-3 or UM-3 type batteries) is approximately one year from installation into the machine.

Power supply/ Power consumption

As noted on the plate affixed to right side of register.

Operating temperature

32°F ~ 104°F (0°C ~ 40°C)

Humidity

10 ~ 90%

Dimensions and Weight

10_{15/16}" (H) × 13_{11/16}" (W) × 15_{9/32}" (D)/13 lbs 4 oz with small size drawer

* Specifications and design are subject to change without notice.

Index

A		F	
Amount tender compulsory	75	Feed key	22
Arithmetic operation key	23	Financial report	79
B		G	
Battery compartment	18	Grand total	47
C		H	
Calculator mode	19, 76	High amount limitation	75
Cancel (key)	22	High digit limitation	66
Cancel (registration)	46	I	
Cash amount tendered key	23	Ink ribbon (location)	18
Change preparation	26	Ink ribbon (replacement)	91
Character entering	60	Ink ribbon (set)	8
Charge (key)	23	Item counter	24
Charge (registration)	40	J	
Check (key)	23	Journal	24
Check (registration)	40	Journal skip	24, 50
Clear (key)	22	K	
Clear (operation)	44	Key (Drawer key)	19
Clerk name	54, 56	Key (Mode key)	18
Clerk number key	22	Key (Operator key)	18
Clerk sign on/off	48	Key (Program key)	18
Commercial message	24, 50	Keyboard	18, 22
Consecutive number	24, 51	Key descriptor	57, 59
Correction	45	L	
Currency exchange	72	Load 1-ply paper for journal	10
D		Load 1-ply paper for receipt	9
Daily sales report	47, 80	Load 2-ply paper	11
Date & time display	26	Logo message	24, 50
Date & time setting	12	Low battery indicator	90
Department descriptor	57	M	
Department key	22	Machine number	24, 52
Department registration	27	Main display	20
Department report	78	Manual tax key	71
Department shift key	23, 27	Memory backup battery	6
Discount	34	Memory recall	77
Display	20	Message	24, 50
Drawer	18, 19	Minus key (reduction)	36
Drawer key	19	Mode key	18
Drawer open key	23	Mode switch	19
Drawer release lever	19	Money declaration	79, 80
E		Multiplication key	22
Equal key	23	Multiplication registration	28, 32, 68
Error code	88		
Error correct key	22		
Error correct registration	45		

- N**
- Negative department 62, 63
 - Negative PLU (subdepartment) 64, 65
 - Non-add key 22
 - Non-add registration 40
 - Non-resettable grand total 47
 - No sale key 22
 - No sale registration 46
- O**
- Open key 22
 - Open key operation 66
 - Operator key 18
- P**
- Paid out key 23
 - Paid out registration 43
 - Paper feed key 22
 - Paper installation 9 ~ 11
 - Percent key 22
 - Percent registration 35, 70
 - Periodic report 83
 - PLU descriptor 58
 - PLU key 22
 - PLU registration 32
 - Pop-up display 20
 - Post receipt 49
 - Post receipt key 22
 - Power failure 90
 - Premium 70
 - Preset price (department) 29
 - Preset price (PLU) 31
 - Preset price (subdepartment) 31
 - Price key 22
 - Printer cover 18
 - Printout selection (Receipt/Journal) 12, 50
 - Program key 18
 - Program read 84 ~ 87
- Q**
- R**
- Read report 78 ~ 83
 - Receipt on/off indicator 20
 - Receipt on/off key 22
 - Received on account key 22
 - Received on account registration 43
 - Reduction (minus key) 36
 - Refund key 22
 - Refund key registration 41
 - Refund mode 19
 - Refund mode registration 42
 - Register mode 19
 - Repeat counter 20
 - Repeat registration 28, 32, 68
 - Report descriptor 54
 - Report title 54, 55
 - Reset report 47, 80 ~ 83
 - Return operation 41, 42
 - Roll paper installation 9 ~ 11
 - Roll paper specification 94
- S**
- Single item sale 66, 67
 - Split pricing 28, 33, 68
 - Store number (machine number) 24, 52
 - Subdepartment 64
 - Subtotal compulsory 51
 - Subtotal key 23
 - Subtotal printing 50
 - Subtotal registration 28
- T**
- Take-up reel 18
 - Tax calculation status (department) 29, 62, 63
 - Tax calculation status (discount/premium) ... 34, 69
 - Tax calculation status (PLU/subdept.) 31, 64, 65
 - Tax calculation status (reduction) 36, 76
 - Tax shift 27, 39
 - Tax table 14 ~ 17
 - Time setting 12
 - Training clerk 53, 80
- V**
- W**
- X**
- X indicator 20
 - X mode 19
 - X report (Read report) 78 ~ 83
- Y**
- Z**
- Z indicator 20
 - Z mode 19
 - Z report (Reset report) 47, 80 ~ 83

LIMITED WARRANTY: ELECTRONIC CASH REGISTERS

This product, except the battery, is warranted by Casio to the original purchaser to be free from defects in material and workmanship under normal use for a period, from the date of purchase, of one year for parts and 90 days for labor. For one year, upon proof of purchase, the product will be repaired or replaced (with the same or a similar model) at Casio's option, at a Casio Authorized Service Center without charge for parts. Labor will be provided without charge for 90 days. The terminal resident software and programmable software, if any, included with this product or any programmable software which may be licensed by Casio or one of its authorized dealers, is warranted by Casio to the original licensee for a period of ninety (90) days from the date of license to conform substantially to published specifications and documentation provided it is used with the Casio hardware and software for which it is designed.

For a period of ninety (90) days, upon proof of license, Casio will, at its option, replace defective terminal resident software or programmable software, correct significant program errors, or refund the license fee for such software. Significant program errors will be significant deviations from written documentation or specifications. These are your sole remedies for any breach of warranty. In no event will Casio's liability exceed the license fee, if any, for such software. This warranty will not apply if the product has been misused, abused, or altered.

Without limiting the foregoing, battery leakage, bending of the unit, a broken display tube, and any cracks or breaks in the display will be presumed to have resulted from misuse or abuse. To obtain warranty service you must take or ship the product, freight prepaid, with a copy of the sales receipt or other proof of purchase and the date of purchase, to a Casio Authorized Service Center. Due to the possibility of damage or loss, it is recommended when shipping the product to a Casio Authorized Service Center that you package the product securely and ship it insured. CASIO HEREBY EXPRESSLY DISCLAIMS ALL OTHER WARRANTIES, EXPRESS OR IMPLIED, INCLUDING ANY IMPLIED WARRANTY OF MERCHANTABILITY OR OF FITNESS FOR A PARTICULAR PURPOSE. NO RESPONSIBILITY IS ASSUMED FOR ANY INCIDENTAL OR CONSEQUENTIAL DAMAGES, INCLUDING WITHOUT LIMITATION DAMAGES RESULTING FROM MATHEMATICAL INACCURACY OF THE PRODUCT OR LOSS OF STORED DATA. SOME STATES DO NOT ALLOW THE EXCLUSION OR LIMITATION OF INCIDENTAL OR CONSEQUENTIAL DAMAGES, SO THE ABOVE LIMITATIONS OR EXCLUSIONS MAY NOT APPLY TO YOU. This warranty gives you specific rights, and you may also have other rights which vary from state to state.

CASIO, INC.
570 MOUNT PLEASANT AVENUE,
P. O. BOX 7000, DOVER, NEW JERSEY 07801 U.S.A.

Model:..... Serial Number:..... Date of Purchase:.....

Your Name:.....

Address:.....

Dealer's Name:.....

Address:.....

CASIO®

CASIO COMPUTER CO., LTD.
6-2, Hon-machi 1-chome
Shibuya-ku, Tokyo 151-8543, Japan

MO0003-A Printed in Malaysia
Imprimé en Malaisie

Printed on recycled paper.

PCR-365A*INC