

PCR-265P

Electronic Cash Register



User's Manual

START-UP is QUICK and EASY!
Simple to use!
10 departments and 100 PLUs
Automatic Tax Calculations
Calculator function

CASIO COMPUTER CO., LTD.
6-2, Hon-machi 1-chome
Shibuya-ku, Tokyo 151-8543, Japan

CASIO® 

Introduction

Thank you very much for purchasing this CASIO electronic cash register.
START-UP is QUICK and EASY!

Part-1 of this User's Manual can help you make a quick start.

Once you have mastered the QUICK START operations, you will undoubtedly want to expand your use of this machine by studying other sections of Part-2.



CASIO Authorized Service Centers

If your CASIO product needs repair, or you wish to purchase replacement parts, please call 1-800-YO-CASIO.

Original Carton/Package

If for any reason, this product is to be returned to the store where purchased, it must be packed in the original carton/package.

Location

Locate the Cash register on a flat, stable surface, away from heaters or areas exposed to direct sunlight, humidity or dust.

Power Supply

Your cash register is designed to operate on standard household current (120 V, 50/60 Hz). Do not overload the outlet by plugging in too many appliances.

Cleaning

Clean the cash register exterior with a soft cloth which has been moistened with a solution of a mild neutral detergent and water, and wrung out.

Be sure that the cloth is thoroughly wrung out to avoid damage to the printer.

Never use paint thinner, benzene, or other volatile solvents.

Contents

Getting to know your cash register	2
Daily Job Flow	4
Part-1 QUICK START OPERATION	5
(You can operate this ECR on a basic level by reading the following sections)	
1. Initialization	5
2. Loading Paper	6
3. Basic Programming for QUICK START – TIME/DATE	7
4. Basic Operation after Basic Programming	13
5. Daily Management Report	16
Part-2 CONVENIENT OPERATION	18
(Please keep these sections to expand your use.)	
1. Various Programming	18
2. Various Operations	27
Part-3 CALCULATOR FUNCTION.....	34
1. Calculator Mode	34
Part-4 USEFUL INFORMATION	36
1. Troubleshooting	36
2. Specifications	36
3. Warranty Card	37

Before you start

Unpacking

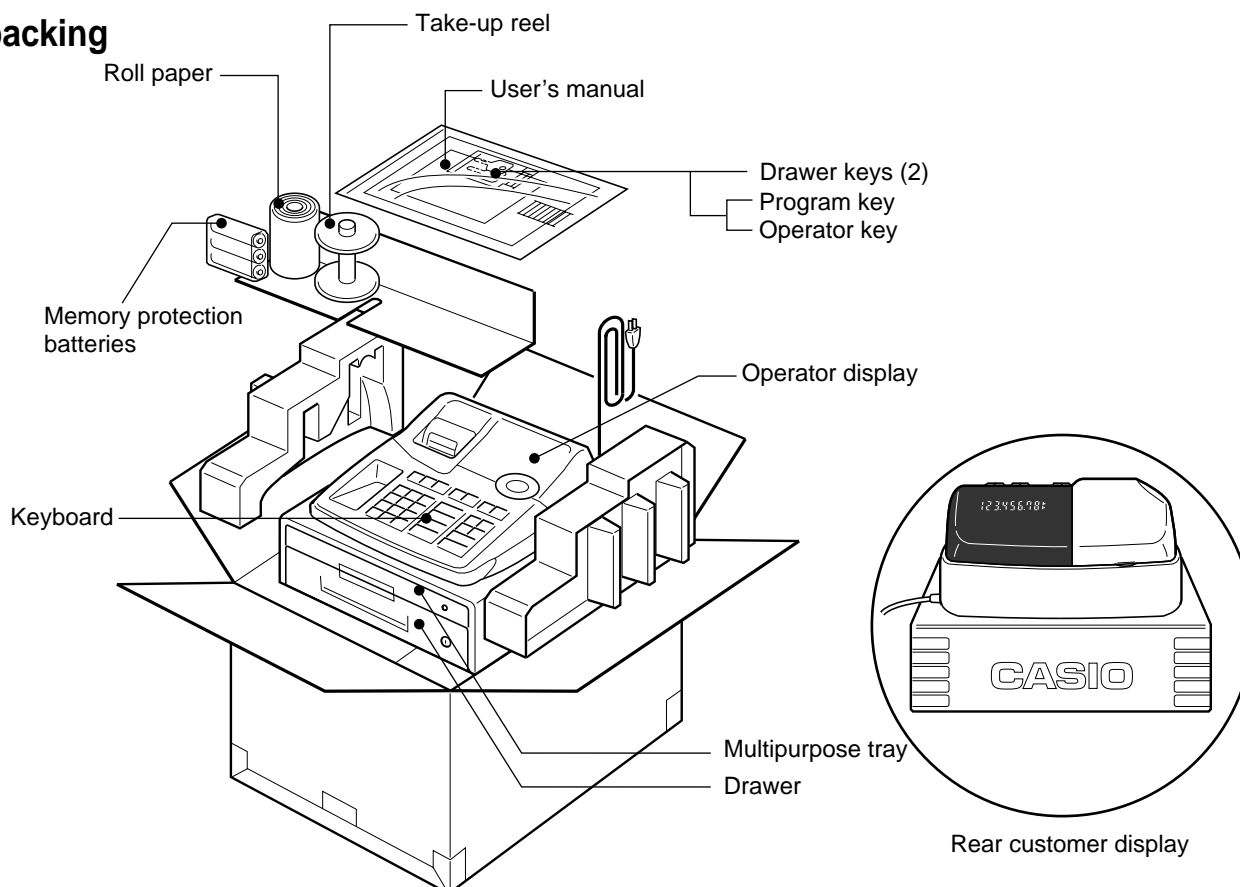

Getting to know your cash register

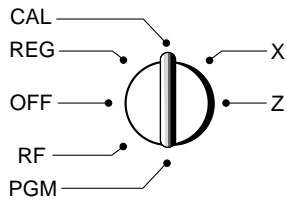

The position of the Mode Switch controls the type of operations you can perform on the cash register. The PROGRAM Key (marked PGM) that comes with the cash register can be used to select any Mode Switch setting, while the OPERATOR Key (marked OP) can be used to select OFF, REG or CAL only.

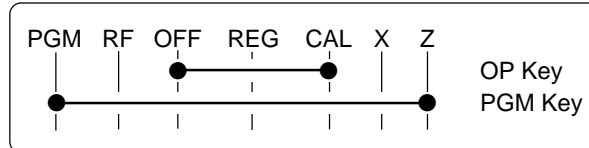

Note:

An error is generated (E01 displayed) whenever the position of the Mode Switch is changed during registration or programming.

OFF

In this position, the power of the cash register is off.

REG (Register)

This is the position used for registration of normal transactions.

RF (Refund)

This is the position used for registration of refunds.

CAL (Calculator)

This is the position used for calculator mode.

PGM (Programming)

This is the position used to program the cash register to suit the needs of your store.

X (Read)

This is the position used to produce reports of daily sales totals without clearing the totals.

Z (Reset)

This is the position used to produce reports of daily sales totals. This setting clears the totals.

Displays

Operator Display

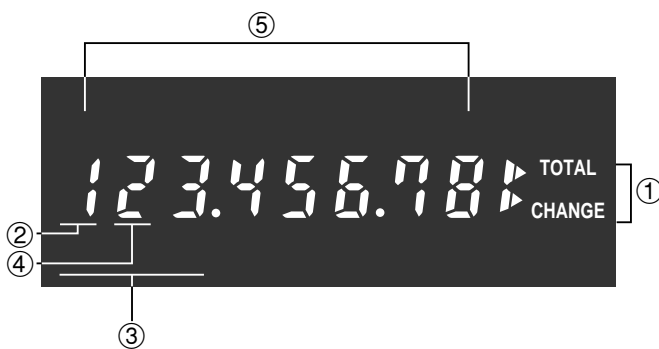

Rear Customer Display

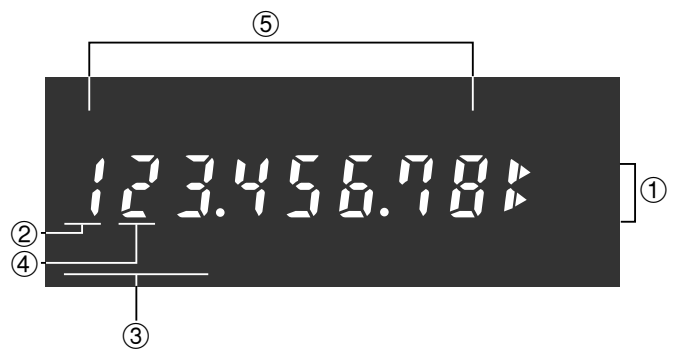

① Total/Change Display

The total (upper segment) or change (lower segment) sign appears when a subtotal, total or change is obtained.

② Department Number Display

Anytime you press a department key to register a unit price, the corresponding department number appears here.

③ PLU Number Display

Anytime you perform a PLU registration, the corresponding PLU number appears here.

④ Number of Repeat Display

Anytime you perform "repeat registration" (page 13), the number of repeats appears here.

Note that only one digit is displayed for the number of repeats.

⑤ Numeric Display

Entered values (unit prices or quantities) and calculated values (subtotals, totals or change amount due) are displayed here. The capacity of the display is 8 digits.

This part of the display can be used to show the current time or date between registration (page 31).

Keyboard

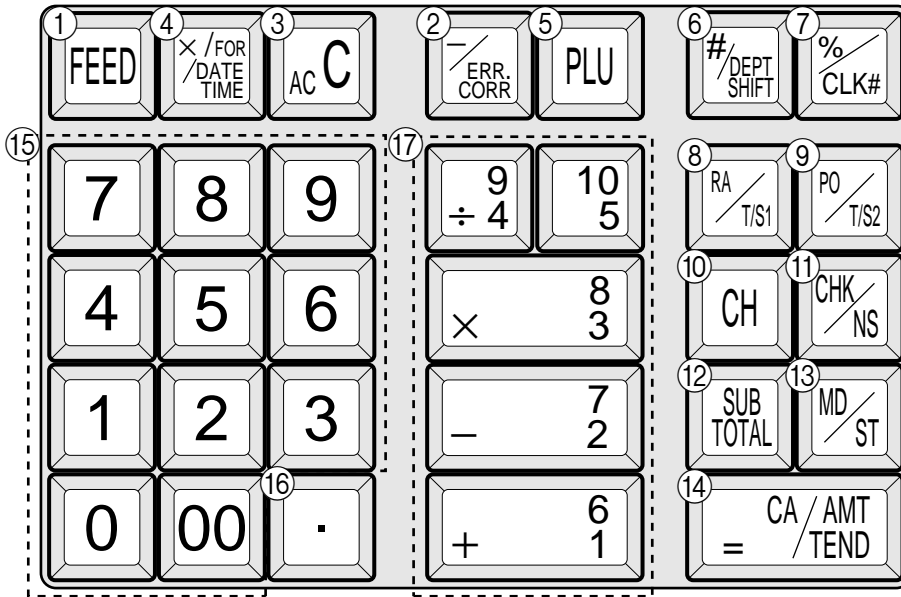

Certain keys have two functions; one for register mode and one for calculator mode.

In this manual, we will refer to specific keys as noted below to make the operations as easy to understand as possible:

Register Mode

- ① Feed key
- ② Minus/Error Correction key
- ③ Clear key
- ④ Multiplication/For/Date Time key
- ⑤ PLU (Price Look Up) key
- ⑥ Reference Number/Department Shift key
- ⑦ Percent/Cashier ID No. Assignment key
- ⑧ Received on Account/Tax Status Shift 1 key
- ⑨ Paid Out/Tax Status Shift 2 key
- ⑩ Charge key
- ⑪ Check/No Sale key
- ⑫ Subtotal key
- ⑬ Merchandise Subtotal key
- ⑭ Cash Amount Tendered key
- ⑮ **0, 1, ~ 9, 00**
Numeric keys and 2-zero key
- ⑯ Decimal key

- ⑰ **+1, -2, x3, ÷4, 105**

Department keys

- Department 6 through 10 are specified by pressing the key respectively as follows:

- 6** → Department 6 **7** → Department 7
- 8** → Department 8 **9** → Department 9
- 10** → Department 10

Calculator Mode

- ③ AC key
- ⑤ Memory Recall key
- ⑦ Percent key
- ⑮ **0, 1, ~ 9, 00**
Numeric keys and 2-zero key
- ⑯ Decimal key
- ⑰ **+1, -2, x3, ÷4**
Arithmetic Operation key
- ⑭ Equal key
- ⑪ Drawer Open key

Daily Job Flow

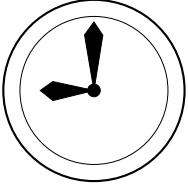

Before Opening The Store

1. Plugged in?
2. Enough Roll Paper?
3. Date and Time is correct?
4. Enough small change in the drawer?

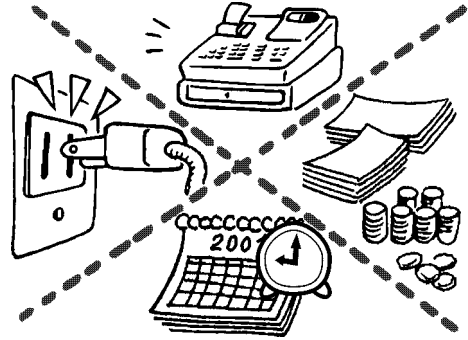

While The Store Is Open

1. Registrations.
2. Issuing latest daily sales total if needed.
(Generating report by Mode Switch to X position.)

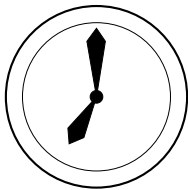

After Closing The Store

1. Issuing Daily Sales Total.
(Resetting report by Mode Switch to Z position.)
2. Picking up money in the drawer.
3. Turn the Mode Switch to OFF.

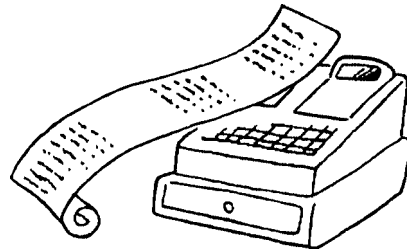

When the cash drawer does not open!

In case of power failure or the machine is in malfunction, the cash drawer does not open automatically. Even in these cases, you can open the cash drawer by pulling drawer release lever (see below).

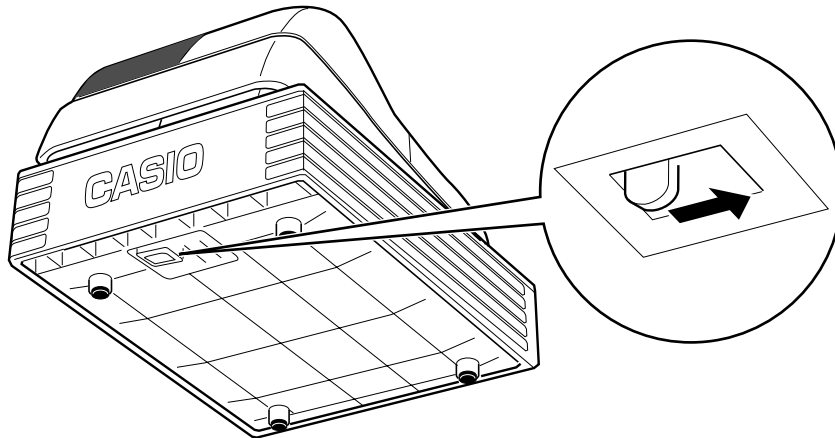

Important!

The drawer will not open, if it is locked with a drawer lock key.



QUICK START OPERATION

Part-1

1. Initialization and Loading Memory Protection Battery

Important

You must initialize the Cash register and install the memory protection batteries before you can program the cash register.

► To initialize the cash register

1. Set the Mode Switch to OFF.
2. Plug the power cord of the cash register into an AC outlet.
3. Load the memory protection batteries.
4. Set the Mode Switch to REG.

► To load the memory protection batteries

1. Remove the printer cover.
2. Press down on the oval just behind the printer paper inlet, and slide the battery compartment cover toward the back of the cash register.
3. Load 3 new SUM-3 ("AA") type batteries into the compartment. Be sure that the plus (+) and minus (-) ends of each battery are facing in the directions indicated by the illustrations inside the battery compartment (Figure 1).
4. Slide the memory protection battery compartment cover back into place.
5. Replace the printer paper and printer cover.



(Figure 1)

REPLACE MEMORY PROTECTION BATTERIES AT LEAST ONCE EVERY YEAR.

To open the multipurpose tray

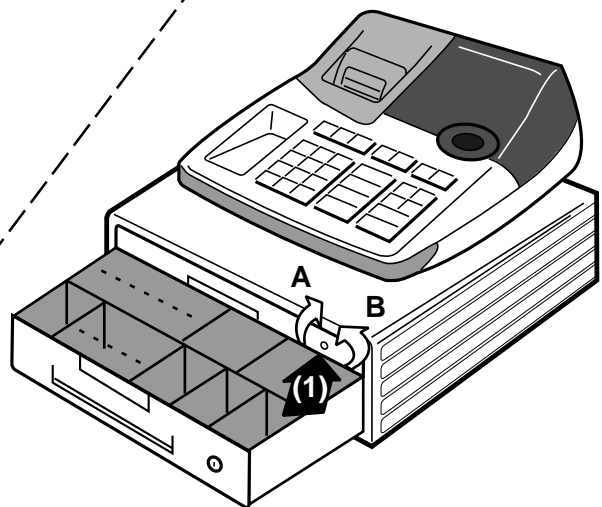
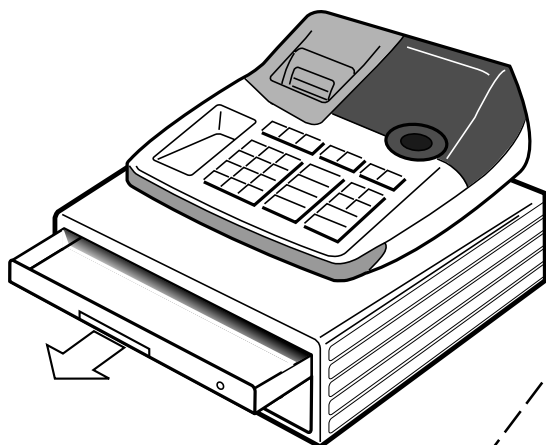

To lock/unlock the multipurpose tray

- A. Turn the lever (1) clockwise to lock the tray (the indicator becomes red).
- B. Turn the lever (1) counterclockwise to unlock the tray (the indicator becomes green).

2. Loading Paper Roll And Replacing The Printer's Ink Roll

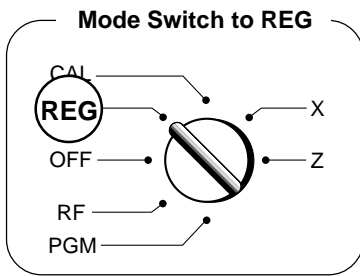

1. To load journal paper

- ① Remove the printer cover by lifting up the back.



- ② Put a roll of journal paper into the holder.
- ③ Cut the leading end of the roll paper with scissors and insert the paper into the inlet.



- ④ Press the **FEED** key until 20 or 30 cm of paper is fed from the printer.
- ⑤ Roll the paper onto the take-up reel a few turns.



- ⑥ Set the left plate of the take-up reel and place the reel into the register.



- ⑦ Press the **FEED** key to take up any slack in the paper.
- ⑧ Replace the printer cover by placing the cover's front tab into the register's groove.



2. To remove journal paper

- ① Remove the printer cover following the instructions above.
- ② Press the **FEED** key until approximately 20cm of the paper is fed from the printer.
- ③ Cut off the roll paper.



- ④ Remove the take-up reel from the printer and take off the left plate of the reel.
- ⑤ Remove the journal paper from the take-up reel.



- ⑥ Cut off the paper left in the printer and press the **FEED** key until the remaining paper is fed out from the printer.



- ⑦ Remove the core of the paper.



- ⑧ Load new paper following the instructions above, and replace the printer cover.

Default printer setting is for Journal.
To print receipts, please refer to 1-7-3 on page 23 to switch the printer for Receipt or Journal.

▶ To load receipt paper

- ① To use the printer to print receipts, follow steps 1 through 4 of "To load journal paper".
- ② Pass the leading end of the receipt paper through the printer cover's paper outlet and replace the printer cover.
- ③ Tear off any excess paper.

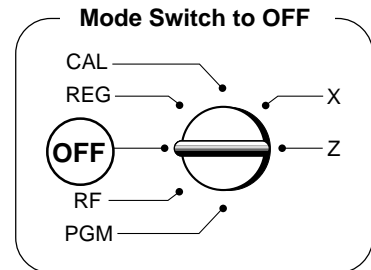

▶ To replace the ink roll

- ① Remove the printer cover.
- ② Lift up the tab on the ink roll marked "PULL UP".



- ③ Install a new Ink Roll and press it down firmly but gently until it snaps into place.
- ④ Replace the printer cover onto the cash register.
- ⑤ Press the **CHK/INS** key to check for correct operation.

Options: Roll paper – P-5860
Ink Roll – IR-40

3. Basic Programming for QUICK START

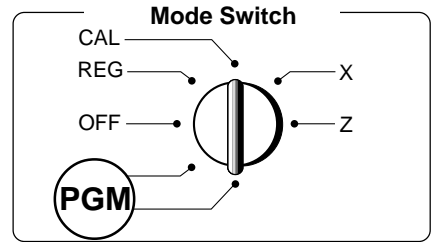

Part-1

Procedure	Purpose																																												
<p>1. Insert the PROGRAM key (marked "PGM") and rotate to PGM position.</p>	Programming																																												
<p>2. Press the following keys to set the current time.</p> <p>Example: 13:18 PM = 1318</p> <div style="display: flex; align-items: center; justify-content: center;"> <div style="text-align: center; margin-right: 10px;"> <p>1 3 1 8</p> <p>Time Minutes</p> </div> <div style="margin-right: 10px;"> <p>1 SUB TOTAL</p> <p>X / FOR / DATE TIME</p> <p>AC C</p> </div> <div> <p>P appears in mode display</p> <p>(to end the time setting)</p> </div> </div> <ul style="list-style-type: none"> • Enter 4 digits • 24-hour time format 	Setting the current time																																												
<p>3. Press the following keys to set the current date.</p> <p>Example: April 19, 2000 = 000419</p> <div style="display: flex; align-items: center; justify-content: center;"> <div style="text-align: center; margin-right: 10px;"> <p>0 0 0 4 1 9</p> <p>Year Month Date</p> </div> <div style="margin-right: 10px;"> <p>1 SUB TOTAL</p> <p>X / FOR / DATE TIME</p> <p>AC C</p> </div> <div> <p>P appears in mode display</p> <p>(to end the date setting)</p> </div> </div> <ul style="list-style-type: none"> • Enter 6 digits • Enter last 2 digits for year set. (2000 → 00) 	Setting the current date																																												
<p>4. For USA</p> <p>Find the tax table for your state on pages 9 through 12 of this manual.</p> <p>Press the following keys to set the tax tables 1 and 2.</p> <p>Example 1: Set Alabama state tax 4%.</p> <div style="display: flex; align-items: center; justify-content: center;"> <div style="text-align: center; margin-right: 10px;"> <p>0 1 2 5</p> <p>3 SUB TOTAL</p> <p>0 CA / AMT / TEND</p> <p>1 CA / AMT / TEND</p> <p>1 CA / AMT / TEND</p> <p>1 0 CA / AMT / TEND</p> <p>3 0 CA / AMT / TEND</p> <p>5 4 CA / AMT / TEND</p> <p>7 3 CA / AMT / TEND</p> <p>1 1 0 CA / AMT / TEND</p> <p>SUB TOTAL</p> </div> <div style="margin-right: 10px;"> <p>P3 appears in mode display</p> <p>Program set code No. for tax table 1</p> <p>1st code for 4%</p> <p>Last code for 4%</p> <p>(to end the setting)</p> </div> <div style="border: 1px solid black; padding: 5px; margin-left: 20px;"> <table border="1"> <thead> <tr> <th colspan="4">ALABAMA</th> </tr> <tr> <th>4%</th> <th>5%</th> <th>6%</th> <th>6%</th> </tr> </thead> <tbody> <tr><td>0</td><td>0</td><td>0</td><td>0</td></tr> <tr><td>1</td><td>1</td><td>1</td><td>1</td></tr> <tr><td>1</td><td>1</td><td>1</td><td>1</td></tr> <tr><td>10</td><td>10</td><td>8</td><td>9</td></tr> <tr><td>30</td><td>29</td><td>24</td><td>20</td></tr> <tr><td>54</td><td>49</td><td>41</td><td>40</td></tr> <tr><td>73</td><td>69</td><td>58</td><td>55</td></tr> <tr><td>110</td><td>89</td><td>70</td><td>90</td></tr> <tr><td></td><td>110</td><td></td><td>109</td></tr> </tbody> </table> </div> </div>	ALABAMA				4%	5%	6%	6%	0	0	0	0	1	1	1	1	1	1	1	1	10	10	8	9	30	29	24	20	54	49	41	40	73	69	58	55	110	89	70	90		110		109	Setting the Tax table 1
ALABAMA																																													
4%	5%	6%	6%																																										
0	0	0	0																																										
1	1	1	1																																										
1	1	1	1																																										
10	10	8	9																																										
30	29	24	20																																										
54	49	41	40																																										
73	69	58	55																																										
110	89	70	90																																										
	110		109																																										

FOR PROGRAMMING ASSISTANCE, PLEASE CALL TOLL FREE 1-800-638-9228

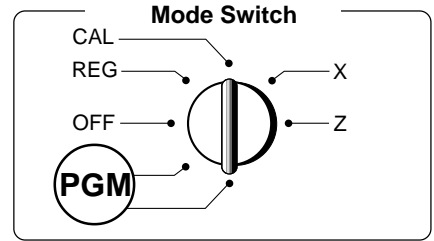

Procedure	Purpose					
<p>Example 2: Set Colorado state tax 5.25%.</p> <p> 3 <input type="button" value="SUB TOTAL"/> 0 2 2 5 <input type="button" value="SUB TOTAL"/> 5 . 2 5 <input type="button" value="CA/AMT TEND"/> 5 0 0 2 <input type="button" value="CA/AMT TEND"/> <input type="button" value="SUB TOTAL"/> </p> <p>P3 appears in mode display Program set code No. for Tax table 2 5.25% tax 50 for Round off and 02 for Add On (to end the setting)</p>	<p>Setting the Tax table 2</p> <table border="1" data-bbox="1252 660 1388 828"> <tr><td>COLORADO</td></tr> <tr><td>5.25%</td></tr> <tr><td>5.25</td></tr> <tr><td>5002</td></tr> </table>	COLORADO	5.25%	5.25	5002	
COLORADO						
5.25%						
5.25						
5002						
<p>• Tax table 2 programming can set only tax rate, but not for a tax break point.</p> <p>4. For CANADA Find the tax table for your province on page 12 of this manual. Press the following keys to set the tax tables 1 and 2.</p> <p>Example 1: Set Quebec tax 9%.</p> <p> 3 <input type="button" value="SUB TOTAL"/> 0 1 2 5 <input type="button" value="SUB TOTAL"/> 9 <input type="button" value="CA/AMT TEND"/> 9 0 0 2 <input type="button" value="CA/AMT TEND"/> <input type="button" value="SUB TOTAL"/> </p> <p>P3 appears in mode display Program set code No. for tax table 1 9% tax 90 for round up and 02 for Add On. (to end the setting)</p>	<p>Setting the Tax table 1</p> <table border="1" data-bbox="1252 1142 1388 1310"> <tr><td>CANADA</td></tr> <tr><td>QUEBEC</td></tr> <tr><td>9%</td></tr> <tr><td>9</td></tr> <tr><td>9002</td></tr> </table>	CANADA	QUEBEC	9%	9	9002
CANADA						
QUEBEC						
9%						
9						
9002						
<p>• Tax table 1 programming is used for the tax table includes break points and tax rate.</p> <p>Example 2: Set Ontario tax 10%.</p> <p> 3 <input type="button" value="SUB TOTAL"/> 0 2 2 5 <input type="button" value="SUB TOTAL"/> 1 0 <input type="button" value="CA/AMT TEND"/> 5 0 0 4 <input type="button" value="CA/AMT TEND"/> <input type="button" value="SUB TOTAL"/> </p> <p>P3 appears in mode display Program set code No. for tax table 2 10% tax rate 50 for Round off and 04 for tax on tax code (to end the setting)</p>	<p>Setting the Tax table 2</p> <table border="1" data-bbox="1252 1512 1388 1680"> <tr><td>CANADA</td></tr> <tr><td>ONTARIO</td></tr> <tr><td>10%</td></tr> <tr><td>10</td></tr> <tr><td>5004</td></tr> </table>	CANADA	ONTARIO	10%	10	5004
CANADA						
ONTARIO						
10%						
10						
5004						
<p>Tax status for the Departments are fixed as follows: Departments 1~5: Taxable status 1 and 2. Departments 6~10: Non-Taxable status.</p> <p>• See page 18 to change the fixed tax status.</p>						

Tax Tables for USA

A

ALABAMA						
4%	5%	6%	6%	6% (4+1+1)	7%	8%
0	0	0	0	0	0	0
1	1	1	1	1	1	1
1	1	1	1	1	1	1
10	10	8	9	10	7	6
30	29	24	20	20	21	18
54	49	41	40	36	35	31
73	69	58	55	54	49	43
110	89	70	70	64	56	
	110	90	85	78	68	
		109	110	92	81	
				107	93	
					106	

ALASKA							
KENAI		HOMER/SELDOVIA		HAINES	JUNEAU	KENAI	KENAI, SEWARD & SOLDOTNA
2%	3%	3%	4%	4%	5%	5%	6%
0	0	0	0	0	0	0	6
1	1	1	1	1	1	1	159
1	1	1	1	1	1	1	2
10	10	8	9	10	7	6	179
30	29	24	20	20	21	18	199
54	49	41	40	36	35	31	219
73	69	58	55	54	49	43	239
110	89	70	70	64	56		259
	110	90	85	78	68		279
		109	110	92	81		300
				107	93		
					106		

ARIZONA						
4%	5%	6%	6.5%	6.7%	7%	
0	0	0	175	0	156	0
1	1	1	191	1	171	1
1	1	1	191	1	171	1
10	10	10	7	192	7	186
37	27	22	23	223	22	216
	47	39	38	238	37	231
	68	56	53	253	52	246
	89	73	69	269	67	261
	109	90	84	284	82	276
		107	99	299	97	291
		125	115		111	
		141	130		126	
		158	146		141	

ARKANSAS							
3%	4%	5%	6%	6.8%	7%	7.5%	
0	0	0	0	0	0	0	0
1	1	1	1	1	1	1	1
1	1	1	1	1	1	1	1
10	10	10	8	6	7	6	6
37	44	37	20	24	19	21	19
	74	40	41	33	35	33	33
	114	60	58	46	49	46	46
		80			64		64
		110			78		78
					92		92
					107		107

C

CALIFORNIA																		
6%	6.25%	6.5%	6.75%	7%	7.25%	7.25%	7.5%	7.75%	8.25%	8.5%	10% Parking	LOS ANGELES						
0	141	0	0	130	6.75	0	121	278	7.25	117	7.25	0	7.75	8.25	0	99	0	99
1	158	1	1	146	5002	1	135	292	5002	131	5002	1	5002	5002	1	111	1	99
7	7	7	7	161	0	0	8	149	0	0	0	1	123	11	104			
10	10	10	10	176	10	10	164	10	6	6	6	5	135	99	114			
22	21	20	192	20	20	20	178	20	19	19	19	17	147	99	124			
39	37	35	207	34	33	192	32	32	33	33	33	29	158	99	134			
56	54	51	223	48	47	207	46	46	46	46	46	41	170	99	144			
73	70	67	238	64	62	221	60	59	59	73	73	52	182	99	154			
90	86	83	253	80	76	235	74	74	74	74	74	64	194	99				
108	103	99	269	96	91	249	88	88	88	88	88	76	205	99				
124	119	115	284	111	107	264	103	103	103	103	103	88	217	99				

COLORADO																							
LOVELAND																							
1.5%	2%	2.5%	3%	3.5%	3.6%	3.85%	4%	4.5%	5%	5%	5.25%	5.5%	5.6%	5.75%	6%	6.1%	6.35%	6.4%	6.45%				
0	0	0	0	0	0	264	0	0	211	0	0	5.25	0	172	0	168	0	165	0	6.1	6.35	6.4	6.45
1	1	1	1	1	1	291	1	1	233	1	1	5002	1	190	1	186	1	182	1	5002	5002	5002	5002
1	1	1	3	2	5	319	2	2	5	255	2	1	6	209	7	204	8	199	2	0	0	0	0
33	24	19	17	17	17	347	16	17	17	277	17	18	18	227	16	222	17	217	17	17	17	17	17
99	74	59	49	42	41	375	37	37	33	299	29	18	18	27	245	25	240	26	24	24	24	24	24
166			83	71	69		63	62	55	49	51	51	51	45	263	43	43	43	41	41	41	41	41
233			116	99	97				77		68	68	68	63	281	61	60	60	58	58	58	58	58
			149	128	124				99		84	84	84	81	299	79	78	78	74	74	74	74	74
			183	157	152				122		118	118	118	99	97	95	95						
				185	180				144		118	118	118	118	115	113	113						
				214	208				166		136	136	136	136	132	130	130						
				242	236				188		154	154	154	154	150	147	147						

COLORADO													
6.5%	6.6%	7%	7.01%	7.1%	7.2%	7.25%	7.3%	7.5%	8%				
0	146	6.6	0	135	7.01	7.1	0	131	7.25	0	130	0	0
1	161	5002	1	149	5002	5002	1	145	5002	1	143	1	1
2	176		4	17			2	159		3	157	3	1
17	192	17	17	21	17	173	6	173	6	171	17	6	6
23	207	21	35	35	20	187	20	187	20	19	18	18	18
38	223	35	49	49	34	201	34	201	34	33	31	31	31
53		49	64	64	48	215	47	215	47	46	43	43	43
69		64			62	229	61	229	61	59	56	56	56
84		78			76	243	75	243	75	73	68	68	68
99		92			90	256	89	256	89	81	81	81	81
115		107			104		102		102	93	93	93	93
130		121			118		116		116	106	106	106	106

CONNECTICUT							
5.25%	6%	7%	7.5%	8%			
0	198	0	0	0	0		
1	218	1	1	1	1		
2		2	1	3	1		
16		8	7	6	6		
27		24	21	19	18		
46		41	35	33	31		
65		58	49	46	46		
84		74	64	59	59		
103		91	78	73	73		
122		108	92				
141		124	107				
160							
179							

D

DISTRICT OF COLUMBIA						
D.C. 5%	D.C. 5.75%	D.C. 6%	D.C. 6%	D.C. 8%	D.C. 9%	
0	5.75	0	0	0	105	
1	5002	1	1	1	116	
1	0	1	1	1	127	
10	8	12	8	12	6	138
22		17	24	16	16	149
42		35	41	27	27	161
82		53	58	39	38	
62		71	74	50	49	
110		89	91	62	61	
		112	108	75	72	
				90	83	
				112	94	

F

FLORIDA											
PANAMA CITY BEACH											
4%	5%	5.25%	6%	6.2%	6.5%	7%	7.5%				
0	175	0	5.25	0	6.2	0	107	0	109	0	93
1	209	1	5002	1	5002	1	123	1	1	1	106
5		1		1		1	138	1	1	1	120
9		9		9		9	153	9	9	9	133
25		20		16		16	169	14	13	146	
50		40		33		33	184	28	26	160	
75		60		50		50	209	42	40	173	
109		80		66		66	61	57	53	186	
125		109		83		83	76	71	66	209	
150				109		109	92	85	80		

G

GEORGIA			
3%	4%	5%	6%
0	0	0	0
1	1	1	1
1	1	1	1
10	10	10	10
35	25	20	20
66	50	40	35
110	75	60	50
	110	110	85
			110

H

HAWAII	
4%	
0	0
1	1
1	1
1	1
10	10
12	12
37	37

N

NEW HAMPSHIRE			
Rooms & Meals		Rooms & Meals	
7%	7%	8%	8%
0	129	0	128
1	143	1	142
8	158	8	157
14	172	35	171
26	186	35	185
39	201	38	200
51		50	
63		62	
75		74	
88		87	
101		100	
115		114	

NEW JERSEY			
3%	3.5%	6%	7%
0	0	0	0
1	1	1	1
1	1	1	1
1	1	1	8
17	14	10	10
41	42	22	21
71	71	38	35
117	100	56	50
	128	72	64
	157	88	78
	185	110	92
	214		107
			121
			135

NEW MEXICO									
3.75%	4.25%	4.375%	4.5%	4.875%	5.175%	5.25%	5.375%	5.575%	5.75%
0	280	0	247	0	239	0	199	5.375	5.75
1	306	1	270	1	1	1	5002	5002	5002
6	333	1	294	4	1	1			
13	359	11	317	11	11	11			
40		35	341	34	33	28			
67		58	364	57	55	47			
93		82	388	79	78	66			
120		105	411	102	100	85			
146		129		125	122	104			
173		152		148	144	123			
200		176		171	167	142			
226		199		194	189	161			
253		223		217	211	180			

6.187%	6.1875%
0	6.187
1	5002
4	0
9	8
23	
40	
56	
72	
88	
104	
120	
136	
153	

NEW YORK												SUFFOLK County	
4%	5%	5.25%	5.75%	6%	6.25%	6.5%	6.75%	7%	7.25%	7.5%	8%	8.25%	8.5%
0	0	5.25	5.75	0	141	0	130	6.75	0	121	7.25	0	106
1	1	5002	5002	1	158	1	146	5002	1	135	5002	1	119
7	5	6		7	7	1	161	8	149	8	139	10	131
10	12	10		10	10	7	176	10	164	10	10	10	144
22	33	27		22	22	23	192	20	178	18	17	17	
38	58	47		38	38	38	207	33	192	31	29	29	
56	83	67		56	54	53		47	207	45	42	42	
72	112	87		72	70	69		62		58	55	54	
88	137	109		88	86	84		76		71	67	67	
104		129		108	103	99		91		85	80	79	
120				124	119	115		107		99	92	92	

NORTH CAROLINA						
3%			4.5%		6%	
0	0	0	188	0	0	0
1	1	1	211	1	1	1
4	5	6	233	6	2	2
9	9	9	255	8	10	8
35	29	25	277	23	24	24
70	59	53	299	48	41	41
116	84	75	322	67	58	58
149	112	95		85	74	74
183	137	122		109	91	91
216		144		129	108	108
		166			124	124

NORTH DAKOTA							
3%	4%	4%	5%	5.5%	6%	6.5%	7%
0	0	0	0	182	0	0	170
1	1	1	1	200	1	1	185
3	5	2	2	219	3	2	200
15	15	15	15	15	15	15	216
33	31	25	20	19	17	31	231
67	51	50	40	37	34	47	29
100	71	75		55	50	62	43
133	100	100		73	67	77	58
166	125	125		91	84	93	72
200				110	108	86	75
				128	124	100	88
				146	139	115	100
				164		154	

O

OHIO							CUYAHOGA Co.		
5%	5.5%	5.75%	6%	6%	6.25%	6.5%	7%	7%	7.75%
0	0	146	5.75	0	0	134	0	123	0
1	1	164	5002	1	1	1	1	138	1
2	2	182		2	3	2	3	153	3
15	15	200		15	16	15	15	169	15
20	18	218		17	17	16	15	184	15
40	36			34	34	30	200	28	28
	54			50	50	46	215	42	42
	72			67	67	61	230	57	57
	90			83	83	76	71	71	71
	109			100	100	92	85	85	85
	127			117	117	107	100	100	100

OKLAHOMA									
2%	3%	3.25%	4%	4.25%	4.5%	5%	5.25%	6%	6.25%
0	0	0	323	0	4.25	0	0	5.25	0
1	1	1	353	1	5002	1	1	5002	1
1	1	1	7	384	1	2	1	1	1
24	16	15	415	12	11	9	8	7	7
74	49	46	446	37	33	29	24	23	23
	83	76	476		55	55	41		
	116	107	507		77	77	58		
		138	538		99	99			
		169	569		121	121			
		199	599		144	144			
		230							
		261							
		292							

P

PENNSYLVANIA						
7%	7.25%	7.375%	8%	8.25%	9.25%	10.25%
0	7.25	7.375	0	0	0	0
1	5002	5002	1	1	1	1
6		0	1	1	4	1
8		6	6	6	5	4
22			18	18	16	14
37			31	30	27	24
51				42	37	34
65				54	48	43
79				66	59	
94				78	70	
108				90	81	
122				103	91	

R

RHODE ISLAND		
6%	7%	
0	0	150
1	1	150
1	5	167
10	10	184
17	17	210
34	34	217
50	50	234
67	50	250
84	67	250
110	84	
	110	
	117	
	134	

R

RHODE ISLAND		
6%	7%	
0	0	149
1	1	164
6	5	178
9	7	192
26	21	207
42	35	221
57	49	235
73	64	249
90	78	264
106	92	
123	107	
140	121	
	135	

S

SOUTH CAROLINA					
CHARLESTON			6%		
4%	5%		6%	6.5%	7%
0	0	0			
1	1	1			
5	6	2			
10	10	10			
25	20	24			
50	40	41			
75	60	41			
112	80	58			
137	109	74			
	129	91			
		108			
		124			

SOUTH DAKOTA						
4%	5%	5.5%	6%	6.5%	7%	
0	0	0	190	0	0	161
1	1	1	210	1	1	176
1	1	1		1	1	192
12	10	10		9	7	207
37	30	28		26	23	
		46		43	38	
		64		60	53	
		82		76	69	
		100		92	84	
		118		109	99	
		136		115	107	
		154		130	121	
		172		146	135	

T

TENNESSEE														
COUNTY TAX														
4.5%	5.5%	6%	6.25%	6.5%	6.75%	7%	7.25%	7.5%	7.75%	8%	8%	8.25%	8.5%	8.75%
0	188	0	154	354	0	0	0	130	0	125	0	121	0	117
1	211	1	172	372	1	1	1	146	1	140	1	1	1	130
1		11	190	390	2	2	2	161	8	155	2	10	158	10
11		10	209		10	10	10	176	10	170	10	20	172	19
33		27	227		24	23	23	192	22	185	21	34	185	33
55		45	245		41	39	38	207	37	199	35	48	185	46
77		63	263		58	55	53	223	51	214	49	61	199	59
99		81	281		74	71	69		66	229	64	81	244	78
122		99	299			87	84		96	259	92	89	259	92
144		119	318				99		111	274	107	103		103
166		136	336				115							

Part-1 QUICK START OPERATION

TEXAS											HOUSTON (Harris County)					DALLAS						
4%	4%	4.125%	4.625%	5%	5.125%	5.25%	5.375%	5.5%	5.625%	6%	6%	6%	6.125%	6.25%	6.25%	6.75%	7%					
0	0	0	181	424	4,625	0	5,125	0	142	5,375	0	137	0	0	0	6,125	0	119	6,250	6,75	0	107
1	1	1	206	5002	1	5002	1	181	5002	1	55	1	151	1	1	1	5002	1	5002	5002	5002	1
1	1	1	230										1	1	1							1
12	12	12	254										8	9	8							7
37	37	36	278										24	25	24							21
	62	60	303										41	42	41							35
	87	84	327										58	59	58							49
		109	351										74	74	74							64
		133	375										91	91	91							78
		157	399										108	103	103							92

7.25%	7.5%	7.75%	8%	8.25%	
7.25	0	0	96	0	8.25
5002	1	1	109	1	5002
	1	5	122	1	
	6	6	135	6	
	19	19	148	18	
	33	32	161	31	
	46	45	174		
	59	58	187		
	73	70			
	86	83			

U

UTAH														
4.75%	5%	5.25%	5.375%	5.5%	5.75%	5.875%	6%	6.125%	6.25%	7%	7.25%			
0	221	0	0	199	0	0	190	5.75	5.875	0	6.125	0	0	7.25
1	242	1	1	219	1	1	209	5002	5002	1	5002	1	1	5002
1	263	1	1	238	1	1				0	2	0	4	2
10	284	9	9	257	9	9			8	8	8	7	7	
31	305	29	28	276	27	27			24	24	23	21	21	
52	326	47	47	295	46	45			41	41	27	35	35	
73	347	66	66	314	65	63			58	58	47	49	49	
94	368	85	85	333	83	81			74	74	63	64	64	
115	389	104	104	352	102	99						78	78	
136	410	123	123	371		118						92	92	
157		142	142	390		136						107	107	
178		161	161	409		154								
199		180	180			172								

V

VERMONT			
3%	4%	5%	8%
0	0	0	0
1	1	1	1
4	2	2	0
13	10	10	18
33	25	20	31
66	50	40	43
100	80	56	
133	100	68	
166	120	81	
200	140	93	

VIRGINIA																					
ARLINGTON COUNTY		FAIRFAX		FAIRFAX CITY		HAMPTON		LEESBURG		RICHMOND		ALEXANDRIA		NEWPORT NEWS		RICHMOND		ROANOKE CITY		VA BEACH	
4%	4%	4.5%	5.5%	6.5%	7%	7%	7%	7%	7%	7.5%	7.5%	7.5%	8%	8.5%	9%						
0	214	484	0	188	0	149	0	114	284	0	0	7.5	0	116	0	0	114	0	99	9	
1	234	512	1	211	1	166	1	144	1	1	1	5002	1	122	1	1	114	1	112	5002	
21	259	537	2	233	4	188	1	166	13	149	5	134	1	144	2	5	134	1	122		
14	284		12	255	11	211	11	174	14	159	7	14		11	149	6	14	134	11	137	
34	314		37	33	277	14	233	24	188	29	184	21	14	16	166	19	34	159	12	144	
59	334		62	55	299	33	249	33	211	34	184	35	34	33	183	33	44	33	162		
84	359		87	77		55	255	55		44	214	49	59	49	188	46	44	37	166		
114	384		112	99	77	74		59	214	64	59	64	59	55	211	59	59	55	187		
134	414		137	122	99	77		74	234	78	84	78	84	77		59	59	62	188		
159	434			144	122	99		84	249	92	84	92	84	83		84	84	77	211		
184	459			166	144	122		114	259	107	114	107	114	99		84	84	87			

W

VIRGINIA					
NORFOLK CITY		CITY OF RICHMOND		9.5%	
Meal tax	9%	Food tax	9.5%		
0	99	211	0	89	205
1	99	233	1	99	1
6	122	233	1	110	1
11	122		5	121	9
33	144		15	131	11
44	144		26	142	29
44	166		36	152	33
55	166		47	163	49
55	188		57	173	55
77	188		68	184	69
77	211		78	194	77

WASHINGTON																	
7%	7.2%	7.3%	7.5%	7.55%	4.125%	7.8%	7.9%	8%	8.1%	8.1%	8.7%						
0	0	131	0	129	0	126	0	0	124	282	7.8	0	0	0	117	8.1	0
1	1	1	1	143	1	139	1	1	138		2	1	1	1	129	2	1
1	1	1	1	156	1	153	2	3	151		0	2	1	14	141	0	1
7	6	6	6	170	6	166	7	6	164		7	6	6	6	154	6	5
21	20	19	184	19	179	19	19	19	177		19	18	18	18	166	18	17
35	34	33	198	33	193	33	32	190			32	31	31	30	179	30	28
49	48	47	211	46	206	46	46	203			44	44	44	43	191	43	
64	62	61	225	59		59	59	217			57	56	55	203	55		
78	76	74	239	73		72	72	230			70		67		67		
92	90	88	252	86		85	85	243			83		80		80		
107	104	102	269	99		98	98	256					92		92		
	118	115		113		111	111	269					104		104		

WEST VIRGINIA				
2%	3%	4%	5%	6%
0	0	0	0	0
1	1	1	1	1
2	2	1	2	2
25	5	12	5	5
50	35	37	20	16
100	70		40	33
	100			50
	135			67
				84
				100
				116

WISCONSIN			
4%	5%	5.5%	5.6%
0	0	0	190
1	1	1	209
1	1	1	1
12	10	9	8
37	21	27	26
	41	45	44
	61	63	62
	81	81	80
	110	99	98
		118	116
		136	133
		154	
		172	

WYOMING			
3%	4%	5%	6%
0	0	0	0
1	1	1	1
2	2	2	3
24	24	24	24
49	37	29	24
83	62	49	34
116		69	51
149		89	68
		109	84

4. Basic Operation after Basic Programming

Note:

Whenever an error is generated (E01 displayed), the input figures reset to 0. All printout samples are receipt images and the header (date, time and consecutive no.) are eliminated from the samples.

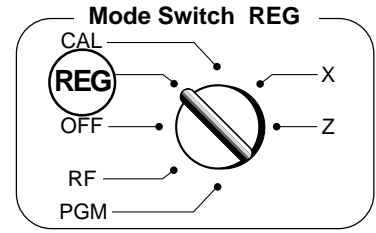

Part-1



4-1 Open the drawer without a sale

CHK / NS

..... NS

No Sales Symbol

4-2 Basic operation

Example

Unit Price	\$1.00	\$2.00
Quantity	1	1
Dept.	1	10
Cash Amount tendered	\$5.00	

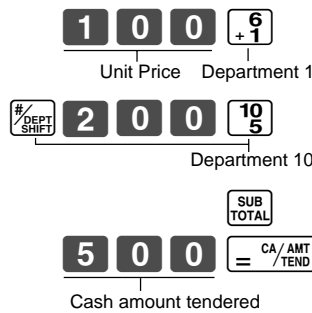

• 1•00 1* — Unit Price/Department No.
 • 2•00 0 — "0" means Department 10.
 • 1•00 TA — Taxable Subtotal
 • 0•04 TX — Tax
 • 3•04 ST — Subtotal
 • 5•00 CA — Cash Amount Tendered
 • 1•96 CG — Change Amount Due

Departments 6 through 10 can also be registered in combination with the $\frac{\#}{\text{DEPT SHIFT}}$ and $\frac{6}{+1}$, $\frac{7}{-2}$, $\frac{8}{\times 3}$, $\frac{9}{+4}$ or $\frac{10}{5}$ keys, respectively. The $\frac{\#}{\text{DEPT SHIFT}}$ key should be entered just before entering unit price manually.

4-3 Multiple registration on the same items

Example

Unit Price	\$1.00	\$1.35
Quantity	2	3
Dept.	1	2

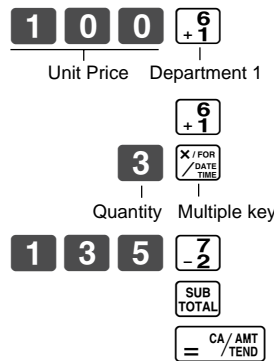

• 1•00 1* — Repeat
 • 1•00 1* — Multiplication Symbol
 3 X — Unit Price Symbol
 • 1•35 @ — Department No.
 • 4•05 2* — Department No.
 • 6•05 TA — Taxable Subtotal
 • 0•24 TX — Tax
 • 6•29 CA — Cash Amount Due

Note that repeated registration can be used with unit prices up to 6 digits long.

4-4 Split sales of packaged items

Example

Unit price	12/\$10.00
Quantity	3
Dept.	1

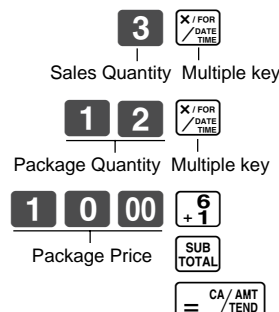

3 X — Sales Quantity
 12 — Package Quantity
 • 10•00 @ — Unit Price
 • 2•50 1* — Multiplication Symbol
 • 2•50 TA — Taxable Subtotal
 • 0•10 TX — Tax
 • 2•60 CA — Cash Amount Due

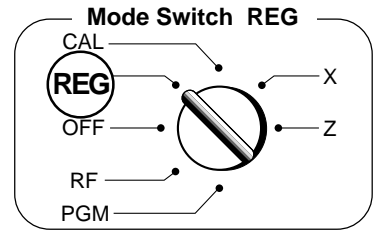

4-5 Charge sales

Example

Unit Price	\$1.00	\$2.00	\$3.00
Quantity	1	1	1
Dept.	1	2	1

Operation	Printout
<p>1 0 0 6 +1</p> <p>2 0 0 7 -2</p> <p>3 0 0 6 +1</p> <p>SUB TOTAL</p> <p>CH</p> <p>Charge key</p>	<p>•1•00 1*</p> <p>•2•00 2*</p> <p>•3•00 1*</p> <p>•6•00 TA</p> <p>•0•24 TX</p> <p>•6•24 CH — Charge Sales</p>

You cannot perform the amount tendered operation using the CH key.

4-6 Split cash/ charge sales

Example

Unit Price	\$2.00	\$3.00	\$4.00
Quantity	1	1	1
Dept.	1	2	1
Cash Amount tendered	\$5.00		

Operation	Printout
<p>2 0 0 6 +1</p> <p>3 0 0 7 -2</p> <p>4 0 0 6 +1</p> <p>SUB TOTAL</p> <p>5 0 0 = CA/AMT TEND</p> <p>CH</p>	<p>•2•00 1*</p> <p>•3•00 2*</p> <p>•4•00 1*</p> <p>•9•00 TA</p> <p>•0•36 TX</p> <p>•9•36 ST</p> <p>•5•00 CA — Cash Amount Tendered</p> <p>•4•36 CH — Charge Sales</p>

4-7 Corrections

Corrections can be made while you are registering the item (before you press a department key), or after it has already been registered into the memory (by pressing a department key).

4-7-1 Before you press a department key

AC C key clears the last item entered.

Example

- Entered 400 for unit price by mistake instead of 100.

Operation	Printout
<p>4 0 0 AC C</p> <p>Wrong entry Clears the last item entered.</p> <p>1 0 0 6 +1</p> <p>Correct entry Registered Department 1</p>	<p>•1•00 1*</p>

Operation

Printout

2. Entered unit price first instead of quantity and then pressed .

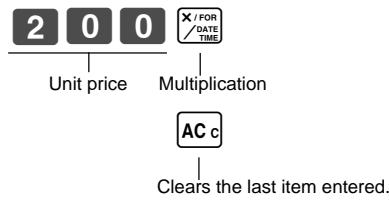

5	X
•2•00	@
•10•00	2*

Part-1

3. Entered 150 for unit price by mistake instead of 105.

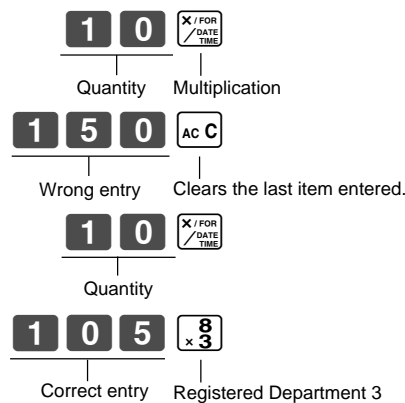

10	X
•1•05	@
•10•50	3*

4-7-2 After you pressed a department key

 key cancels the last registered item.

Example

1. Entered unit price 550 by mistake instead of 505 and pressed a department key.

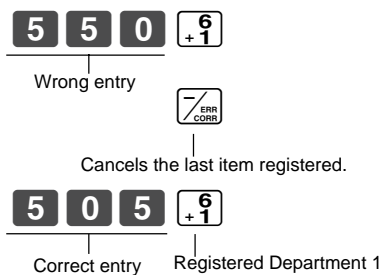

•5•50	1*
-5•50	∅
•5•05	1*

2. Entered unit price 220 by mistake instead of 230 and pressed a department key.

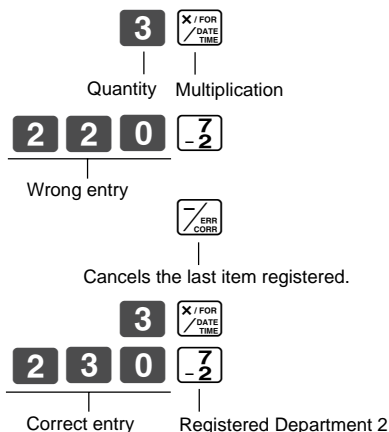

3	X
•2•20	@
•6•60	2*
-6•60	∅
3	X
•2•30	@
•6•90	2*

5. Daily Management Report

This section tells you the procedures to use to produce reports of the transaction data stored in the cash register's memory.

Important

Remember that when you issue a reset (Z) report, the data that is reported is cleared from the applicable totalizers. To view data without clearing totalizers, issue a read (X) report.

5-1 Financial Report

Operation

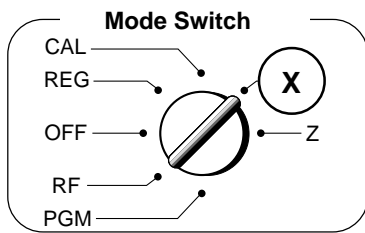

X / FOR
DATE

Printout

04-19-00	_____	Date
14-27 0072	_____	Time/Consecutive No.
	X	Read Symbol
67	*	Gross Sales No. of Items
•270•48	*	Gross Sales Amount
38	NT	Net Sales No. of Customers
•271•24	NT	Net Sales Amount
•197•57	CA #	Cash Total in Drawer
•18•19	CH #	Charge Total in Drawer
•45•18	* CK	Check Total in Drawer

5-2 General Control Read/Reset Report

Operation

5-2-1 Daily Read/Reset Report

Mode Switch to **X**
(Read)

= CA / AMT
/ TEND

Mode Switch to **Z**
(Reset)

= CA / AMT
/ TEND

Printout

Z (Reset) report

04-19-00	_____	Date
19-35 0073	1	Time/Consecutive No. /Clerk No.
0001	Z	Non-resettable Sales No. of Resets/RESET Symbol*1
48	1	No. of Items/Dept. No.
•50•10		Amount
28	2	
•76•40		
17	3	
•85•80		
4	4	
•76•00		
1	5	
•6•50		
0	6	
•0•00		
0	9	
•0•00		
10	0	
•22•00		
108	*	Gross Sales No. of Items
•316•80	*	Gross Sales Amount

•0•50	-	Reduction Amount
•0•66	% +	Premium/Discount Amount
•105•10	TA	Taxable Amount for Tax Table 1
•4•20	TX	Tax Amount for Tax Table 1
•75•60	* TA	Taxable Amount for Tax Table 2
•3•97	TX 2	Tax Amount for Tax Table 2
46	NT	Net Sales No. of Customers
•325•13	NT	Net Sales Amount
•325•13	1	Clerk Sales Amount/ Clerk No.
44	CA	Cash Sales Count
•203•91	CA	Cash Sales Amount
3	CH	Charge Sales Count
•16•22	CH	Charge Sales Amount
2	CK	Check Sales Count
•105•00	CK	Check Sales Amount
•6•00	RA	Received On Account Amount
•10•00	PO	Paid Out Amount
3	VD	Error Correction Count
1	RF	Refund (by MODE operation) Count
•3•00	RF	Refund (by MODE operation) Amount
5	CA X	No. of $\left[\frac{CA}{AMT} \right]$ key operation
1	NS	No-sales Count
•199•91	CA #	Cash in Drawer
•16•22	CH #	Charge in Drawer
•105•00	* CK	Check in Drawer
000000		Non-resettable Grand Sales Total
0325•13		(printed only on RESET report)* ²

* X (Read) report is the same except *1 and *2.

5-2-2 Periodic Read/Reset Report

Operation

Printout

Mode Switch to **X** or **Z**

1 0 $\left[\frac{CA}{AMT} \right]$ / TEND

04-19-00	_____	Date
19-50 0074	_____	Time/Consecutive No.
10	X	Read Symbol
	X	
67	*	Gross Sales No. of Items
•270•73	*	Gross Sales Amount
38	NT	Net Sales No. of Customers
•271•24	NT	Net Sales Amount



CONVENIENT OPERATION

1. Various Programming

1-1 Unit price for Departments

Example

Unit Price	\$1.00	\$2.20	\$11.00
Dept.	1	2	3

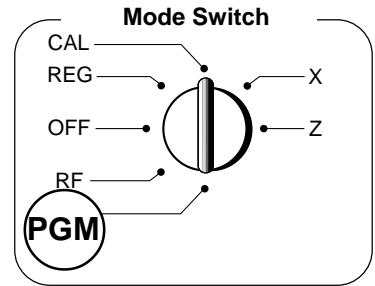
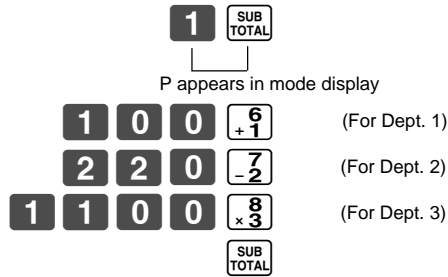

• Unit prices within the range of 0.01~9999.99.

1-2 Rate for percent key

Example

Discount Rate	2.5%
---------------	------

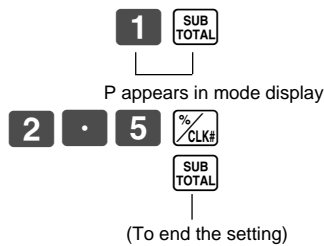

• The rate within the range of 00.01 to 99.99%.

1-3 To change tax status for Departments

Tax status for the Departments are fixed as follows:

Departments 1~5: Taxable status 1 and 2.

Departments 6~10: Non-Taxable status.

Example

Status	Non-taxable	Taxable 1
Depts.	1~5	6~10

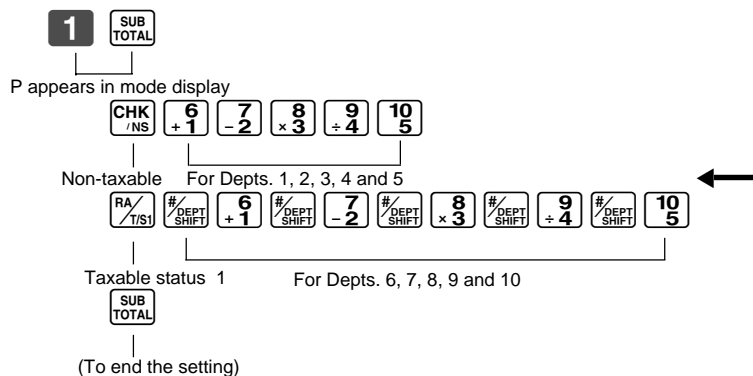

Selections	
Taxable status 1	RA /T/S1
Taxable status 2	PO /T/S2
Taxable status 1 and 2	RA /T/S1 PO /T/S2
Non-taxable status	CHK /NS

A

1-4 Status for Department

Example

Depts.	Selections		
	A	B	C
1	0	4	1
2	0	5	1

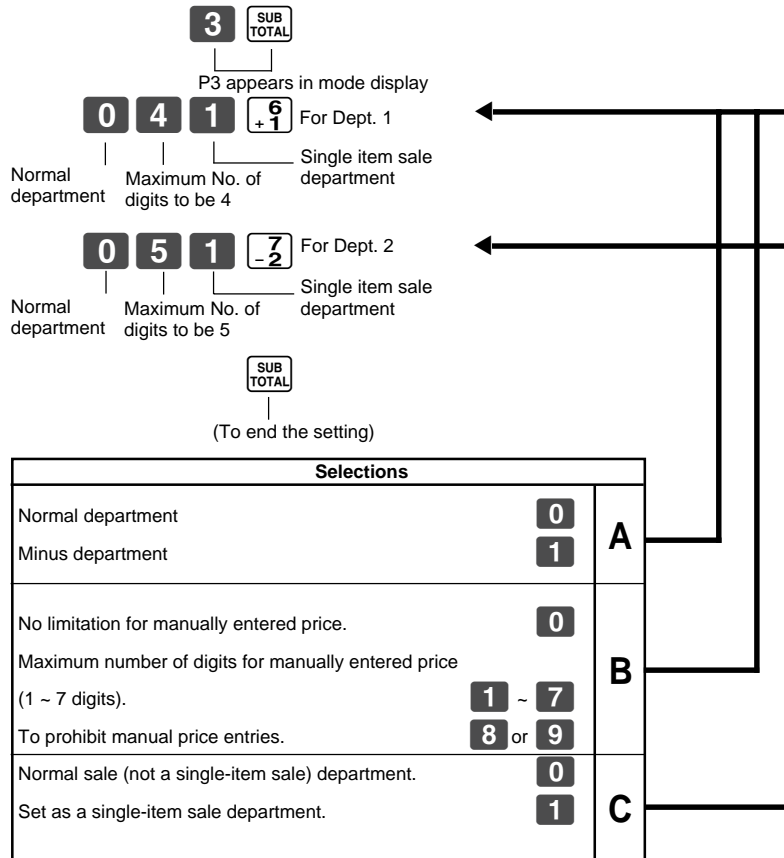

Part-2

1-5 Status for percent key

1-5-1 To change taxable status for the percent key

Taxable status 1 and 2 are fixed for the percent key.

Example

Change Percent key registration as a Non-taxable.

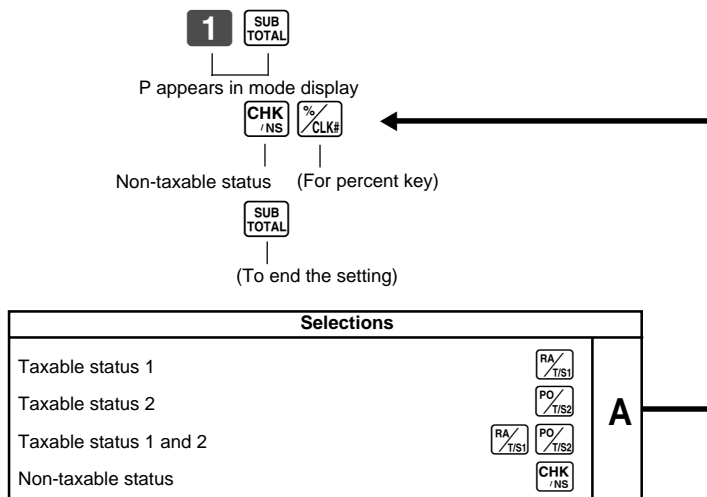

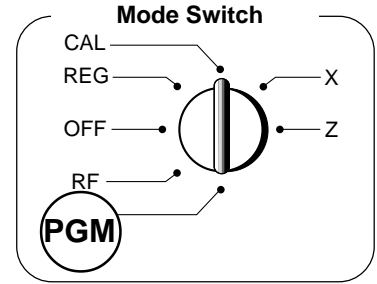

1-5-2 Status for percent key

Example

Round	Up
Percent	%+

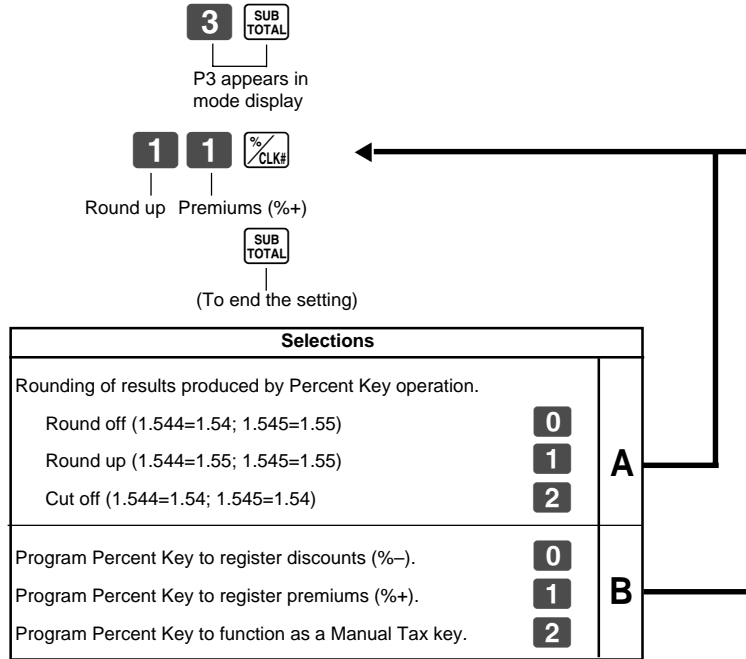

1-6 Taxable Status for minus key

Taxable status 1 and 2 are fixed for the minus key.

Example

Change minus key registrations
Non-taxable status.

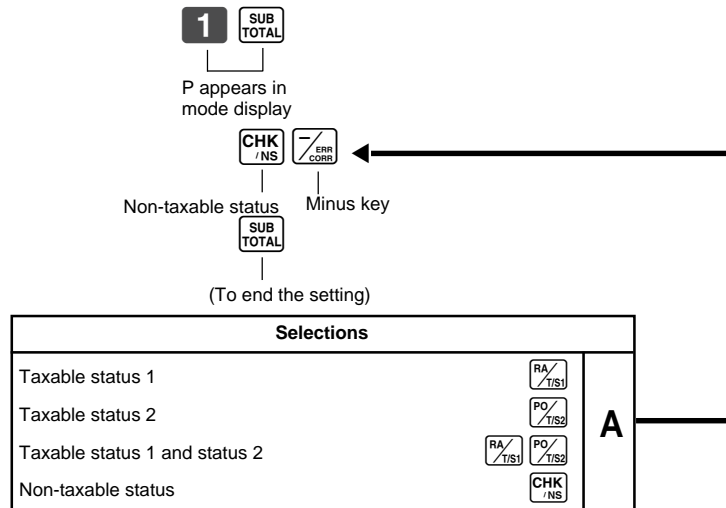

1-7 General features

1-7-1 To set general controls

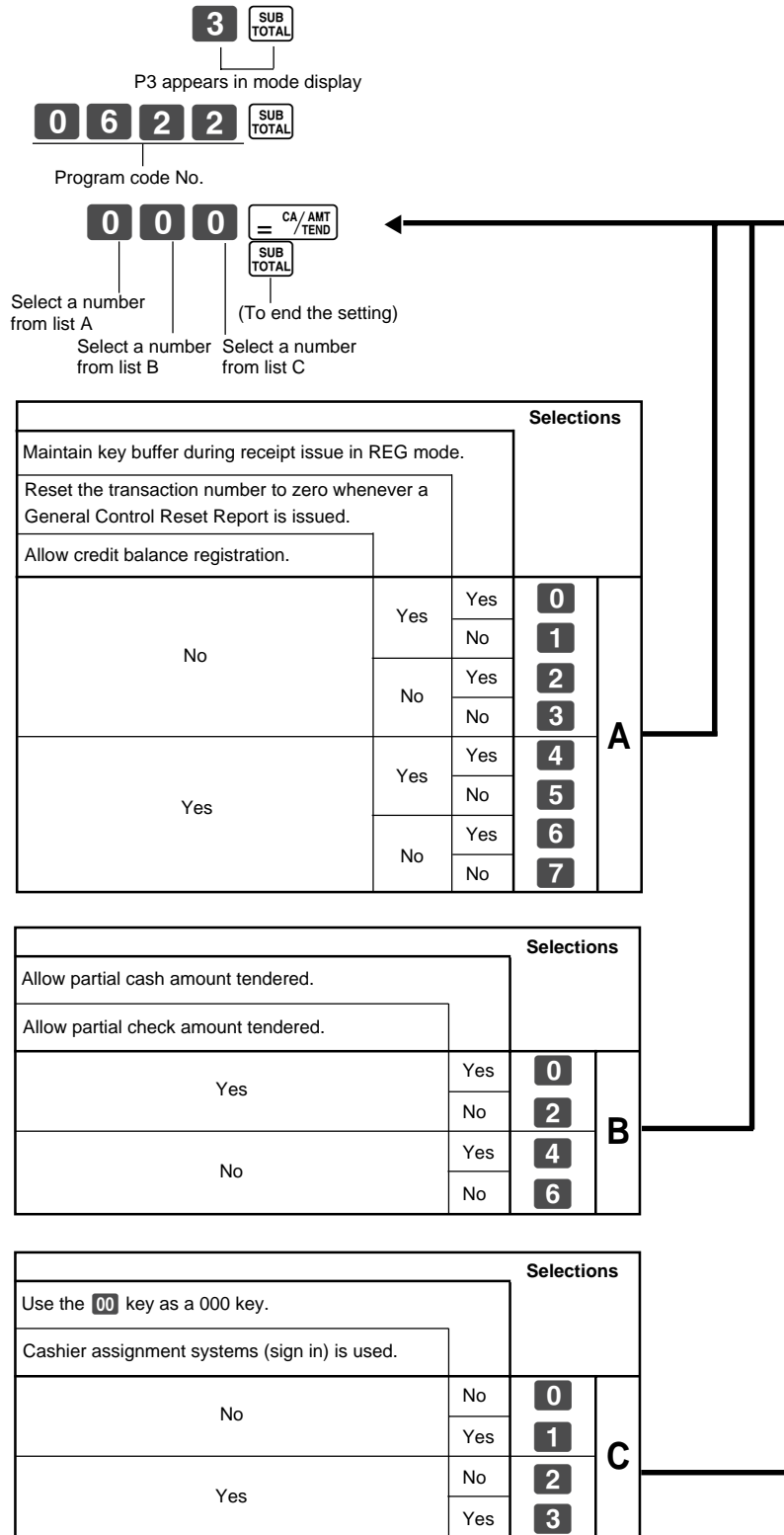

1-7-2 To set printing controls

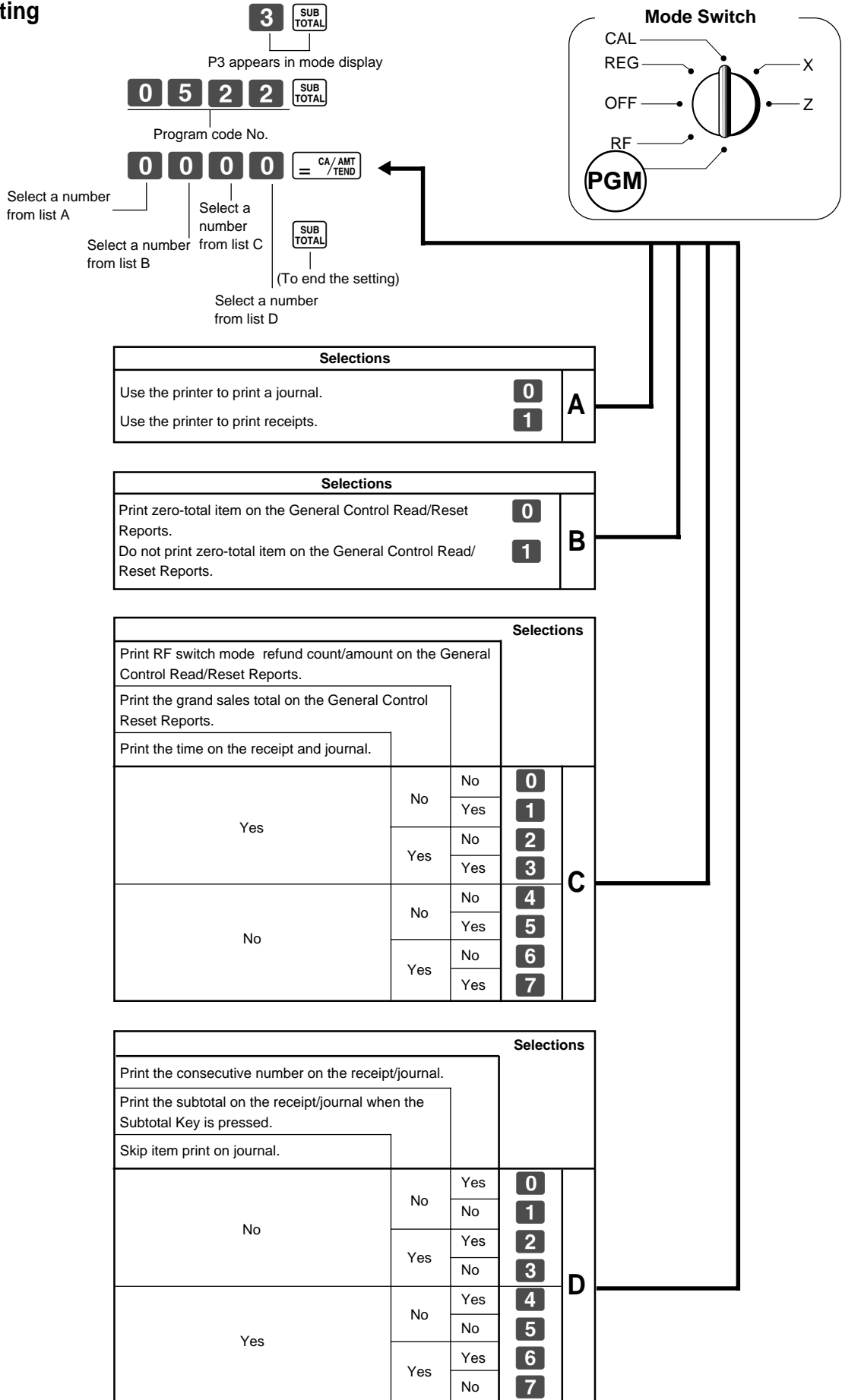

1-7-3 Printer switch for Receipt or Journal

The printer is fixed as journal after initialized operation.

Example

To print a receipt.

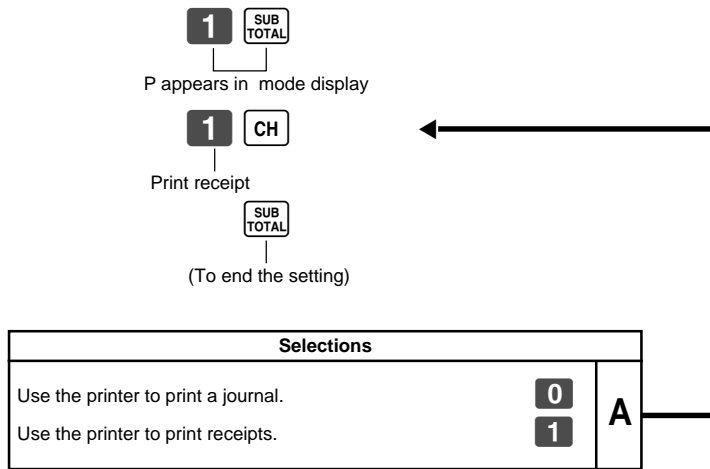

- Printer selection to print a journal or receipts can also be set on procedures 1-7-2 “To set printing controls”.

1-8 PLU setting

1-8-1 Linkage with Departments

Example

PLU No.	1	100
Link Dept. No.	1	10

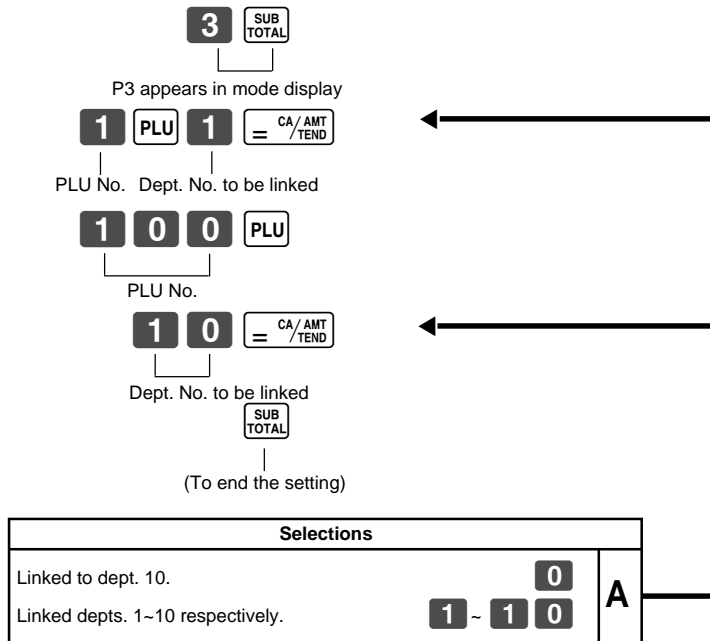

- 100 PLUs can be set.
- When the linked department is not specified, the PLU is linked to department 10.
- Status for a single-item sale and tax status are followed the specified linked department.

Note:

DO NOT link to minus department.

1-8-2 Unit Prices for PLUs

Example

PLU No.	1	2
Unit Price	\$1.00	\$3.00

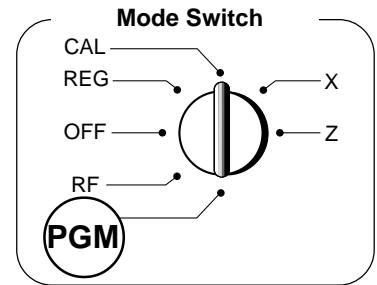
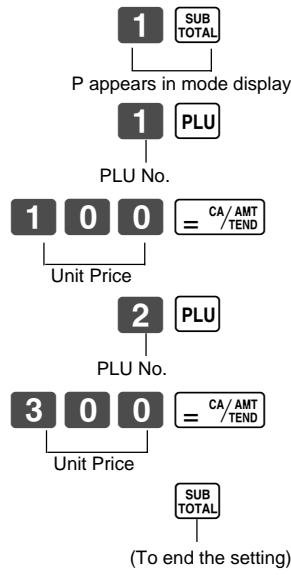

• Unit prices within the range of \$0.01~999.99.

1-9 To control Tax Status printing

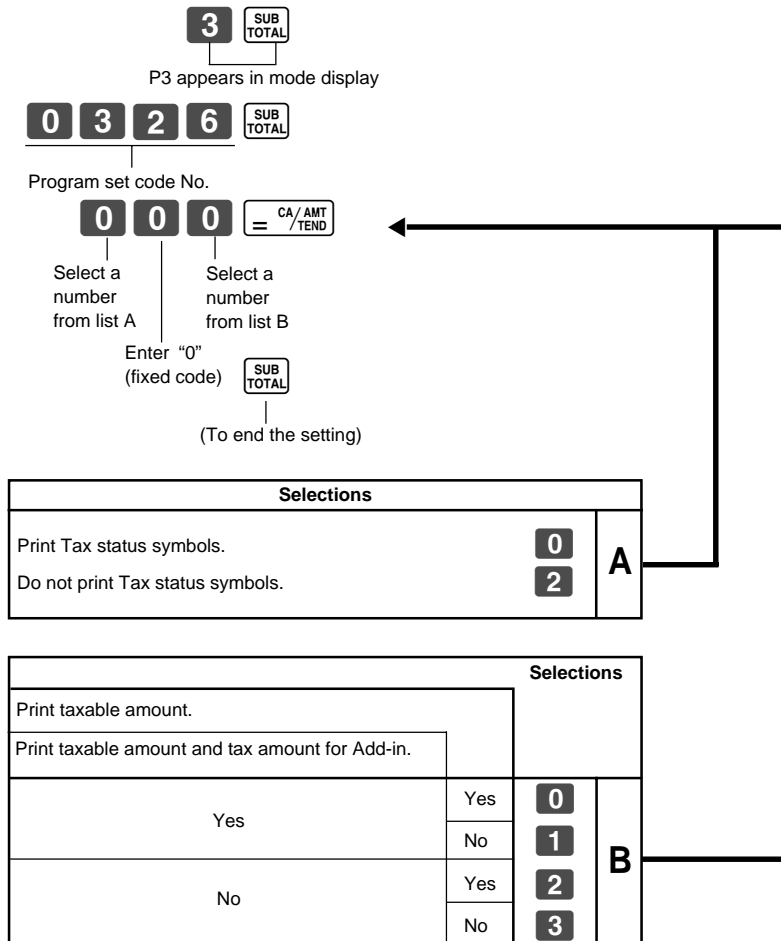

1-10 Printing to read All Preset Data

1-10-1 Printing preset data except PLU settings

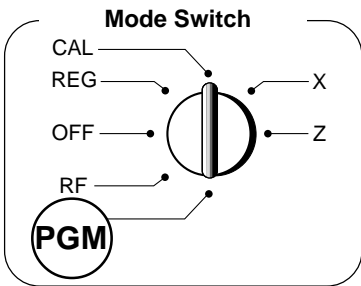

Operation

Printout

CA/AMT/TEND

04-19-00	_____	Date
14-24 0070	_____	Time/Consecutive No.
	X	Read Symbol
1.....1.00	*	Dept. No./Unit Price/Tax Status
.041		Normal Dept./Digit Limit/Single Item
2.....2.20	*	
.051		
3.....11.00	*	
.000		
0.....0.00	*	
.000		
-.....	#	Minus/Tax Status
2.5	%	Percent Rate/%+ or %-
.11	#	Percent Key Control/Tax Status
0122.....12		Date/Add Mode Control (fixed)
0522...1022		Print Control
0622...0000		General Control
1022.....0		Calculation Control
0326...0002		Tax Control
0125.....		
0.0000	%	Tax Table 1
0001		Break Points Control
10		
30		
54		
73		
110		
0225.....		Tax Table 2
5.2500	%	Rounding Specifications/ Tax System Specifications
5002		
0000		
04-19-00		

Part-2

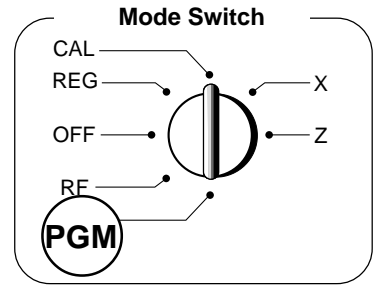

1-10-2 Printing preset PLU settings

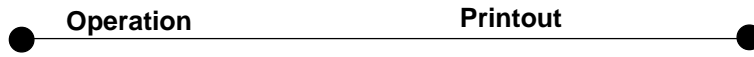

1 CA/AMT/TEND

04-19-00	—	Date
14-26 0073	—	Time/Consecutive No.
X	—	Read symbol
001•••1•00	1	PLU No./Unit Price/ Linked department
002•••2•00	2	
003•••3•00	3	
004•••4•00	4	
005•••5•00	5	
006•••6•00	6	
007•••7•00	7	
009•••0•00	9	"0" means department 10.
100••10•00	1	
04-19-00		

2. Various Operations

2-1 Registration using preset price for Departments.

(Programming: See page 18)

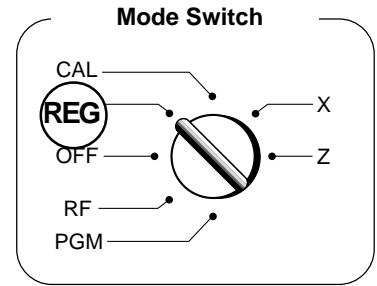

Example

Unit Price	\$1.00	\$2.20	\$11.00
Quantity	1	2	4
Depts.	1	2	3
Amount tendered	\$52.00		

Operation

6 + 1
7 - 2
7 - 2
4 X / FOR / DATE / TIME x 3
SUB TOTAL
5 2 0 0 = CA / AMT / TEND

Printout

• 1•00	1*	Unit Price Programmed to Department 1
• 2•20	2*	Unit Price Programmed to Department 2
• 2•20	2*	Repeat
4	X	Multiplication Symbol
• 11•00	@	Unit Price Programmed to Department 3
• 44•00	3*	
• 49•40	TA	
• 1•98	TX	
• 51•38	ST	
• 52•00	CA	Cash Amount Tendered
• 0•62	CG	Change

Part-2

2-2 Single-Item Sales

(Programming: See page 19)

Example 1

Status	Single item sale
Unit Price	\$.50
Quantity	1
Dept.	1

5 0 6 + 1

• 0•50	1*	
• 0•50	TA	Taxable Amount
• 0•02	TX	Tax
• 0•52	CA	Cash Sales

For this example, Dept. 1 is programmed for a single-item-sale.

(Programming: See page 19.)

Example 2

Status	Normal	Single item sale
Unit Price	\$1.00	\$0.50
Quantity	1	1
Dept.	2	1

1 0 0 7 - 2
5 0 6 + 1
SUB TOTAL
= CA / AMT / TEND

• 1•00	2*	
• 0•50	1*	
• 1•50	TA	Taxable Amount
• 0•06	TX	Tax
• 1•56	CA	Cash Sales

Single-item sale cannot be finalized if an item is registered previously.

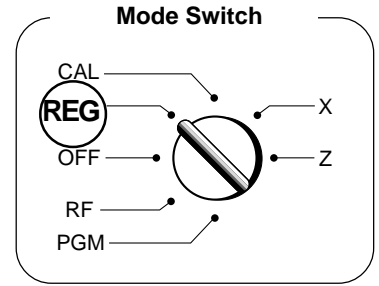

2-3 Check Sales

Example

Unit Price	\$35.00
Quantity	2
Dept.	4

Operation

3 5 0 0 $\frac{9}{+4}$

$\frac{9}{+4}$

SUB TOTAL

CHK / NS

Printout

```

•35•00 4*
•35•00 4*
•70•00 TA
•2•80 TX
•72•80 CK — Check Sales
    
```

2-4 Change the Tax Status

(Programming: See page 18)

Example

Unit Price	\$1.00	\$2.00
Quantity	1	1
Depts.	1	2
Preset Status	Taxable 1	Taxable 1
This Registration	Non-taxable	Taxable 1

$\frac{RA}{T/S}$

1 0 0 $\frac{6}{+1}$

2 0 0 $\frac{7}{-2}$

$\frac{CA}{AMT TEND}$

Printout

```

•1•00 1
•2•00 2 TX
•2•00 TA
•0•08 TX
•3•08 CA
    
```

2-5 Manual Tax

Example

Unit Price	\$1.00	\$2.00
Quantity	1	1
Depts.	1	2

1 0 0 $\frac{6}{+1}$

1 0 $\frac{\%}{CLK}$

2 0 0 $\frac{7}{-2}$

$\frac{CA}{AMT TEND}$

Printout

```

•1•00 1*
•0•10 TX # — Manual Tax Symbol
•2•00 2*
•3•00 TA
•0•12 TX
•3•22 CA
    
```

$\frac{\%}{CLK}$ key is programmed to function as a Manual Tax key (see page 20).

2-6 PLU operation

(Programming: See page 23)

Example

PLU No.	1	2
Unit Price	\$1.00	\$2.00
Quantity	2	4
Link Dept. No.	1	1
Cash Amount tendered	\$10.40	

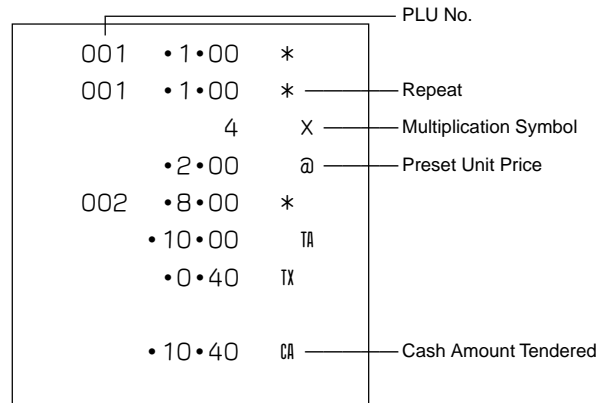
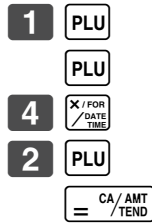

2-7 PLU Single-Item Sale

(Programming: See page 23)

Example

PLU No.	1
Status	Single item sale
Unit Price	\$1.00
Quantity	1

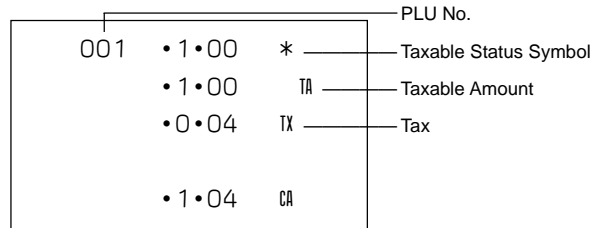

- For this example, linked department 1 is programmed for a single-item-sale. (Programming: See page 19)
- Single-item sale cannot be finalized if an item is registered previously.

2-8 Split cash/ check sales

Example

Unit Price	\$30.00	\$25.00
Quantity	1	1
Depts.	2	3
Cash Amount tendered	\$20.00	
Check	\$37.20	

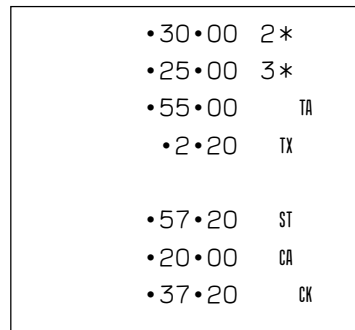
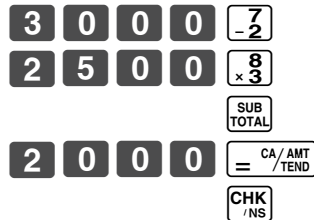

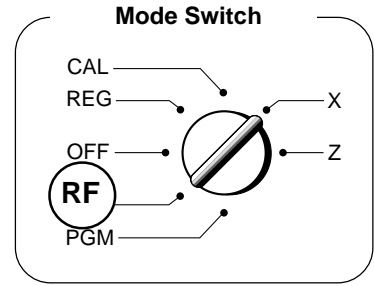

2-9 Refund

Operation

Printout

Example

Unit Price	\$1.00	\$2.00
Quantity	1	1
Dept.	2	3

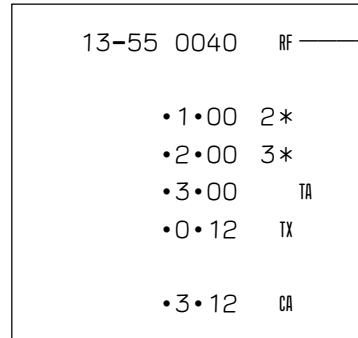
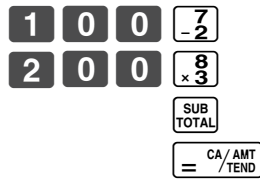

Refund Mode Symbol

After you finish RF mode operation, be sure to return the Mode Switch to the REG (register) setting.

2-10 Cashier Assignment

(Programming: See page 21)

Cashier assignment system is used to control each cashier (or clerk) sales total. When you select this function on page 21, you can get 8 cashiers (or clerk) sales data.

Cashier assignment must be performed prior to starting registration or any other operation, except Program mode.

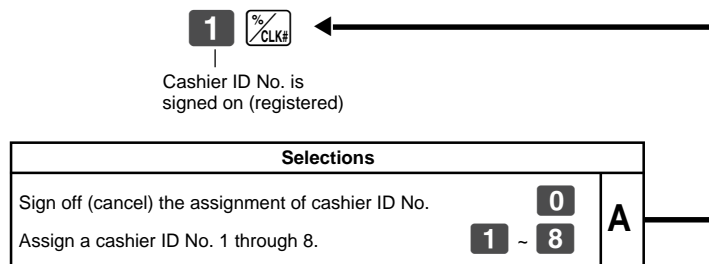
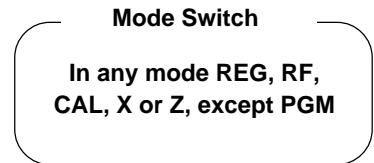

- Currently assigned cashier (or clerk) ID number is printed on the receipt or journal for each transaction.
- The assigned clerk memory number is automatically signed off when the mode key is set to OFF position.
- The assigned cashier (or clerk) sales totals with ID number are printed on the receipt or journal when you perform daily X/Z sales report.

Mode Switch

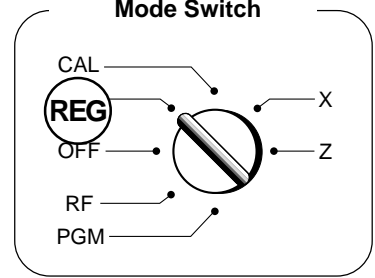

2-11 Other registrations

2-11-1 Reading the Time and Date

Operation	Display	
<input checked="" type="checkbox"/> / FOR / DATE TIME	<div style="border: 1px solid black; padding: 2px; display: inline-block;">13-53</div>	Hour/Minute
<input checked="" type="checkbox"/> / FOR / DATE TIME	<div style="border: 1px solid black; padding: 2px; display: inline-block;">04-19-00</div>	Month/Date/Year
AC C	<div style="border: 1px solid black; padding: 2px; display: inline-block;">0.00</div>	

• Flashes per second

2-11-2 Paid out from cash in drawer

Operation	Printout	
<div style="display: flex; justify-content: space-around;"> 1234 </div> <div style="display: flex; justify-content: space-around;"> 5678 </div> <div style="text-align: center;"> </div> <div style="text-align: center;">Enter reference No.</div> <div style="display: flex; justify-content: space-around;"> 1000 </div>	<div style="border: 1px solid black; padding: 5px;"> 12345678 # 04-19-00 13-57 0041 •10•00 PO </div>	Reference Number Paid Out Amount

2-11-3 Cash received on account

Operation	Printout	
<div style="display: flex; justify-content: space-around;"> 600 </div>	<div style="border: 1px solid black; padding: 5px;"> •6•00 RA </div>	Received On Account Amount

2-11-4 Registering identification numbers

A reference number or ID number of up to 8 digits can be registered prior to any transaction.

<div style="display: flex; justify-content: space-around;"> 1234 </div> <div style="display: flex; justify-content: space-around;"> 5678 </div> <div style="text-align: center;">5 0</div>	<div style="border: 1px solid black; padding: 2px; display: inline-block;"># / DEPT SHIFT</div> <div style="border: 1px solid black; padding: 2px; display: inline-block;">6 + 1</div> <div style="border: 1px solid black; padding: 2px; display: inline-block;">= CA / AMT / TEND</div>	<div style="border: 1px solid black; padding: 5px;"> 12345678 # 04-19-00 13-59 0046 •0•50 1* •0•50 TA •0•02 TX •0•52 CA </div>	Reference No. or ID No.
--	---	--	-------------------------

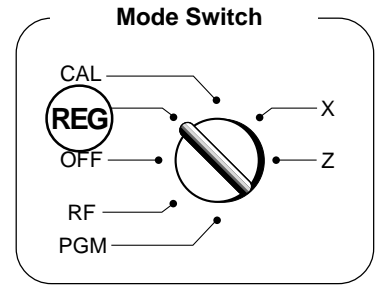

2-11-5 Reduction on subtotal

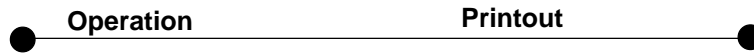

Example
Amount due reduced by \$0.50.

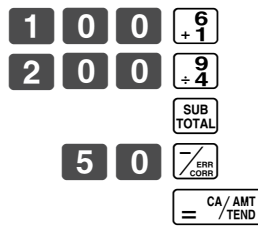

•1.00	1*
•2.00	4*
•3.12	ST
-0.50	
•3.00	TA
•0.12	TX
•2.62	CA

See page 22 to print the subtotal line.

2-11-6 Premium/Discount

- 2.5% premium/discount (programmed to $\frac{\%}{\text{CLK}}\#$ key) applied to first item.
- Be sure to use $\frac{\text{MD}}{\text{ST}}$ key when you wish to apply a premium/discount to the subtotal. You cannot use the SUB TOTAL key.
- 7% premium/discount applied to transaction total.
- For programming the $\frac{\%}{\text{CLK}}\#$ key as percent minus or percent plus, see page 20.
- For programming percent rate, see page 18.

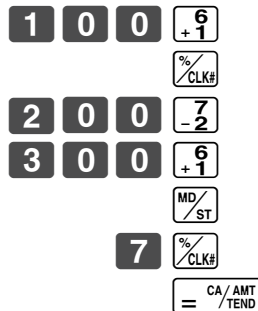

Premium

•1.00	1*
2.5	% — Premium Rate
•0.03	* — Premium Amount
•2.00	3*
•3.00	1*
•6.03	ST — Subtotal
7	% — Premium Rate
•0.42	* — Premium Amount
•6.45	TA
•0.26	TX
•6.71	CA

Discount

•1.00	1*
2.5	% — Discount Rate
-0.03	* — Discount Amount
•2.00	3*
•3.00	1*
•5.97	ST — Subtotal
7	% — Discount Rate
-0.42	* — Discount Amount
•5.55	TA
•0.23	TX
•5.78	CA

2-12 PLU report

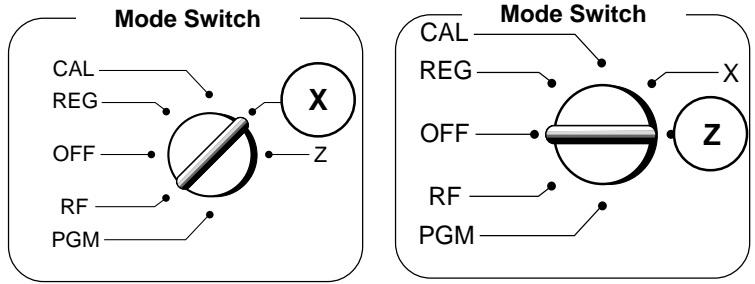

Operation **Printout**

Mode Switch to **X**
(Read)

Mode Switch to **Z**
(Reset)

0 1 = CA/AMT / TEND

```

04-19-00
19-35 0073

01 0001 Z
001 12
    •12•00
002 27
100
    •180•00

1284
•10856•89
    
```

Z — Report code/Reset Counter
 — PLU No./No. of items
 — Amount
 — PLU total count
 — PLU total amount

Part-2

2-13 About the daylight saving time

It is possible to set the internal clock forward/backward by 1~9 hour(s) for the daylight saving time.

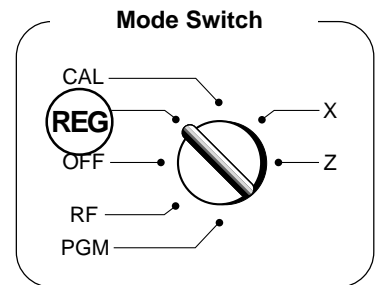

Operation **Display**

• Forward by 1 hour

FOR DATE TIME
 * **1**
 FOR DATE TIME
 AC C

12 - 34
 12 - 34 (blinking)
 13 - 34
 0.00

Set forward by 1 hour.

• Backward by 1 hour

FOR DATE TIME
 - 7 / 2
 * **1**
 FOR DATE TIME
 AC C

12 - 34
 12 - 34 (blinking)
 12 - 34 (blinking)
 11 - 34
 0.00

Set backward by 1 hour.

*Put **2 ~ 9**, in case of set the clock by 2~9 hours.

Part 3

CALCULATOR FUNCTION

1. Calculator Mode

While registering at REG mode, you can switch to CAL mode and then return to REG mode to resume the registration.

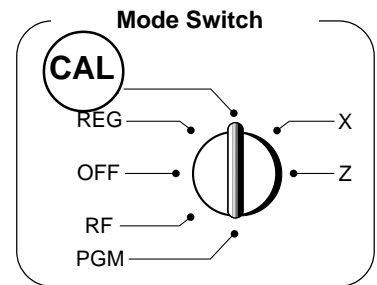

1-1 Calculation examples

	Operation	Display
	<div style="display: flex; justify-content: center; gap: 5px;"> AC c </div> <div style="display: flex; justify-content: center; gap: 5px; margin-top: 5px;"> 5 +⁶₁ 1 AC c </div> <p style="text-align: center; margin-top: 5px;">(Cancels item entered.)</p>	<div style="background-color: black; color: white; padding: 5px; display: flex; justify-content: space-between;"> C 0 </div>
5+3-2=	<div style="display: flex; justify-content: center; gap: 5px;"> 5 +⁶₁ 3 -⁷₂ 2 = CA/AMT/TEND </div>	<div style="background-color: black; color: white; padding: 5px; display: flex; justify-content: space-between;"> 6. </div>
(23-56)×78=	<div style="display: flex; justify-content: center; gap: 5px;"> 2 3 -⁷₂ 5 6 ×⁸₃ 7 8 = CA/AMT/TEND </div>	<div style="background-color: black; color: white; padding: 5px; display: flex; justify-content: space-between;"> -2574. </div>
(4×3-6)÷3.5+8=	<div style="display: flex; justify-content: center; gap: 5px;"> 4 ×⁸₃ 3 -⁷₂ 6 ÷⁹₄ 3 . 5 +⁶₁ 8 = CA/AMT/TEND </div>	<div style="background-color: black; color: white; padding: 5px; display: flex; justify-content: space-between;"> 9.7142857 </div>
12% on 1500	<div style="display: flex; justify-content: center; gap: 5px;"> 1 5 0 0 ×⁸₃ 1 2 % CLK# </div>	<div style="background-color: black; color: white; padding: 5px; display: flex; justify-content: space-between;"> 180. </div>

1-2 Memory recall

Recalls the current amount onto the display.

- during registration: current subtotal
- registration has been completed: the last amount

On CAL mode

	Operation	Display
	<div style="display: flex; justify-content: center; gap: 5px;"> PLU ÷⁹₄ 3 = CA/AMT/TEND </div> <p style="text-align: center; margin-top: 5px;">Memory recall</p>	<div style="background-color: black; color: white; padding: 5px; display: flex; justify-content: space-between;"> 10. </div>

On REG mode

Recalls the current result by pressing CA/AMT/TEND key at CAL mode on the display.

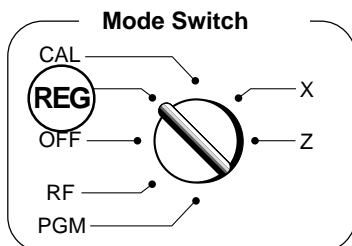

Example
Recall the current result at CAL mode during registration, and register the cash amount due for each person.

	Operation	Printout
	<div style="display: flex; justify-content: center; gap: 5px;"> PLU = CA/AMT/TEND </div> <div style="display: flex; justify-content: center; gap: 5px; margin-top: 5px;"> PLU = CA/AMT/TEND </div> <div style="display: flex; justify-content: center; gap: 5px; margin-top: 5px;"> PLU = CA/AMT/TEND </div> <p style="text-align: center; margin-top: 5px;">Memory recall</p>	<div style="font-family: monospace; padding: 10px;"> <p>•10.00 1</p> <p>•20.00 2</p> <p>•30.00 ST</p> <p>•10.00 CA</p> <p>•10.00 CA</p> <p>•10.00 CA</p> <p>•0.00 CG</p> </div>

1-3 Setting for calculator operation

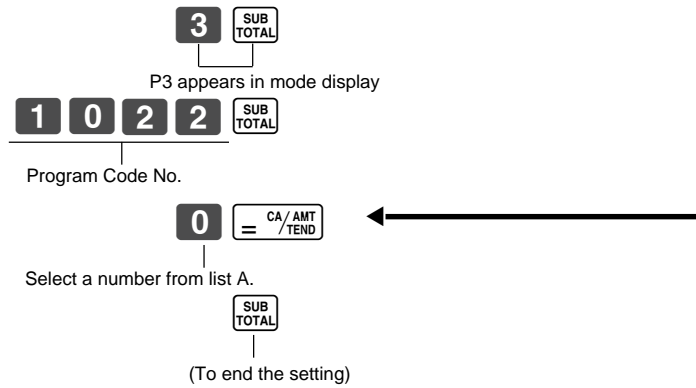
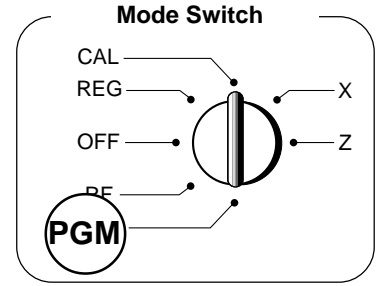

			Selections	
Open drawer whenever <input type="checkbox"/> CA/AMT/TEND is pressed.*				
Open drawer whenever <input type="checkbox"/> CHK is pressed.				
Print No. of Equal key operations on General Control X and Z reports.				
Yes	No	No	0	A
		Yes	1	
	Yes	No	2	
		Yes	3	
No	No	No	4	
		Yes	5	
	Yes	No	6	
		Yes	7	

* Drawer does not open during registration procedures even if you press CA/AMT/TEND by turning the mode switch to CAL position.



USEFUL INFORMATION

1. Troubleshooting

	Symptom/Problem	Most common causes	Solutions
1	E01 appears on the display.	Changing modes without completing transaction.	Return key to where it stops buzzing and press .
2	E08 appears on the display.	Sign on operation is not performed.	Prior to starting registration of any other operation, press 1 ~ 8 and then .
3	E94 appears on the display.	Printer paper is jammed.	Remove jammed paper. Turn Mode switch to OFF then turn to ON, or Turn power OFF and then turn power ON.
4	No date or time on receipt. Paper is not advancing enough.	Printer is programmed as a journal.	Program printer to print receipts.
5	Key won't turn to Z, X, PGM and RF modes.	Using OP key.	Use the PGM key.
6	Drawer opens up after ringing up only one time.	Department is programmed as a single item dept.	Program the dept. as a normal dept.
7	Not clearing totals at end of day after taking report.	Using X mode to take out reports.	Use Z mode to take out reports.
8	Programming is lost whenever register is unplugged or there is a power outage.	Bad or no batteries.	Put in new batteries.
9	Register is inoperative. Can't get money out of drawer.	No power.	Pull lever underneath register at rear.

Note:

If you cannot resolve your difficulty, please feel free to call your dealer or 1-800-638-9228.

2. Specifications

INPUT METHOD

Entry: 10-key system; Buffer memory 6 keys (2-key roll over)
 Display (Digitron): Amount 8 digits (zero suppression); Department/PLU No.; No. of repeats; TOTAL; CHANGE

PRINTER

Receipt: 14 digits (Amount 10 digits, Symbol 4 digits)
 (or journal) Automatic paper roll winding (journal)
 Paper roll: 58 mm × 80 mm Ø (Max.)

CALCULATIONS

Entry 8 digits; Registration 7 digits; Total 8 digits

CALCULATOR FUNCTION

8 digits; Arithmetic calculations; Percent calculations

Memory protection batteries:

The effective service life of the memory protection batteries (3 UM-3, R6P (SUM-3) or LR6 (AM-3) type batteries) is approximately one year from installation into the machine.

Power source: AC 120V, AC (±10%) fixed.
 Power consumption: 0.07A on stand-by; 0.11A maximum
 Operating temperature: 32°F to 104°F (0°C to 40°C)
 Humidity: 10 to 90%
 Dimensions: 8 3/4"(H)×13"(W)×14 3/16"(D) with S drawer
 (222 mm(H)×330 mm(W)×360 mm(D))
 Weight: 9 lbs 4 oz (4.2 kg) with S drawer

Specifications and design are subject to change without notice.

**GUIDELINES LAID DOWN BY FCC RULES FOR USE OF THE UNIT IN THE U.S.A.
(Not applicable to other areas)**

WARNING: This equipment has been tested and found to comply with the limits for a Class A digital device, pursuant to Part 15 of the FCC Rules. These limits are designed to provide reasonable protection against harmful interference when the equipment is operated in a commercial environment. This equipment generates, uses, and can radiate radio frequency energy and, if not installed and used in accordance with the instruction manual, may cause harmful interference to radio communications. Operation of this equipment in a residential area is likely to cause harmful interference in which case the user will be required to correct the interference at his own expense.

FCC WARNING: Changes or modifications not expressly approved by the party responsible for compliance could void the user's authority to operate the equipment.

LIMITED WARRANTY: ELECTRONIC CASH REGISTERS

This product, except the battery, is warranted by Casio to the original purchaser to be free from defects in material and workmanship under normal use for a period, from the date of purchase, of one year for parts and 90 days for labor. For one year, upon proof of purchase, the product will be repaired or replaced (with the same or a similar model) at Casio's option, at a Casio Authorized Service Center without charge for parts. Labor will be provided without charge for 90 days. The terminal resident software and programmable software, if any, included with this product or any programmable software which may be licensed by Casio or one of its authorized dealers, is warranted by Casio to the original licensee for a period of ninety (90) days from the date of license to conform substantially to published specifications and documentation provided it is used with the Casio hardware and software for which it is designed.

For a period of ninety (90) days, upon proof of license, Casio will, at its option, replace defective terminal resident software or programmable software, correct significant program errors, or refund the license fee for such software. Significant program errors will be significant deviations from written documentation or specifications. These are your sole remedies for any breach of warranty. In no event will Casio's liability exceed the license fee, if any, for such software. This warranty will not apply if the product has been misused, abused, or altered.

Without limiting the foregoing, battery leakage, bending of the unit, a broken display tube, and any cracks or breaks in the display will be presumed to have resulted from misuse or abuse. To obtain warranty service you must take or ship the product, freight prepaid, with a copy of the sales receipt or other proof of purchase and the date of purchase, to a Casio Authorized Service Center. Due to the possibility of damage or loss, it is recommended when shipping the product to a Casio Authorized Service Center that you package the product securely and ship it insured. CASIO HEREBY EXPRESSLY DISCLAIMS ALL OTHER WARRANTIES, EXPRESS OR IMPLIED, INCLUDING ANY IMPLIED WARRANTY OF MERCHANTABILITY OR OF FITNESS FOR A PARTICULAR PURPOSE. NO RESPONSIBILITY IS ASSUMED FOR ANY INCIDENTAL OR CONSEQUENTIAL DAMAGES, INCLUDING WITHOUT LIMITATION DAMAGES RESULTING FROM MATHEMATICAL INACCURACY OF THE PRODUCT OR LOSS OF STORED DATA. SOME STATES DO NOT ALLOW THE EXCLUSION OR LIMITATION OF INCIDENTAL OR CONSEQUENTIAL DAMAGES, SO THE ABOVE LIMITATIONS OR EXCLUSIONS MAY NOT APPLY TO YOU. This warranty gives you specific rights, and you may also have other rights which vary from state to state.

CASIO, INC.
570 MOUNT PLEASANT AVENUE,
P. O. BOX 7000, DOVER, NEW JERSEY 07801 U.S.A.

Model: Serial Number: Date of Purchase:

Your Name:

Address:

Dealer's Name:

Address:

CASIO®

CASIO COMPUTER CO., LTD.
6-2, Hon-machi 1-chome
Shibuya-ku, Tokyo 151-8543, Japan

PCR-265PB*INC
MO0203-A